

Standard Detection - 5m

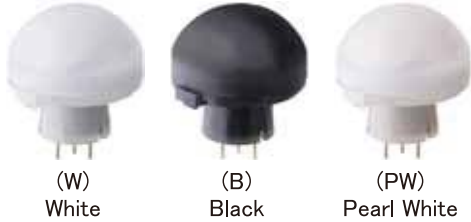

Long Distance Detection - 12m

FEATURES

Simplified circuitry with fully integrated sensor design

Panasonic's proprietary high-density embedded circuit design eliminates external sensing circuits. Advantages include reduced development and design schedules.

Low curvature lens for product designs

Panasonic's lens formation technology achieves a semi-flat lens with a smooth surface and minimum protrusion from the device. In addition to white and black lens options, pearl white is offered for design aesthetics. (※Refer to "Dimensions" on page 5)

Robust design prevents false detection

PaPIRS sensing circuits are enclosed in a metallic can to minimize adverse effects of external electromagnetic fields. Examples include irradiated noise caused by cellular phones.

A high S/N ratio minimizes sensitivity to false tripping when operated under various environmental conditions.

Lead-free pyroelectric elements

PaPIRS sensing elements contain lithium tantalate and are lead-free. Typical PIR sensing elements are ferroelectric ceramic (PZT) containing lead.

APPLICATIONS

Commercial / Residential Equipment

- Lighting fixtures, Sensor switches
- Video intercoms, Vending machines
- Home automation control panels

Home Appliances (Energy Savings)

- Television and PC monitor
- Air conditioners, Air purifiers

What is passive infrared type?

This sensor detects changes in infrared radiation which occur when there is movement by a person (or object) which is different in temperature from the surroundings.

- 1 As this sensor detects temperature differences, it is well suited to detecting the motion of people by their body temperature.
- 2 Wide sensing area.

Compliance with RoHS Directive

Block Diagram (Digital output circuit)

Built-in amplifier and comparator connected directly to a microcomputer.

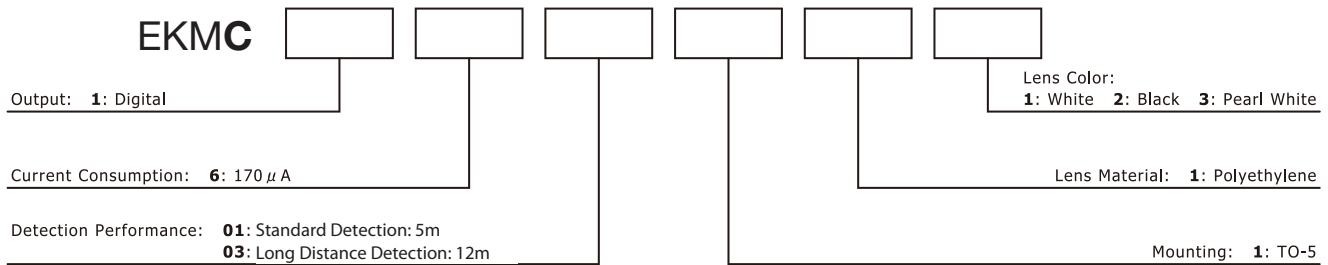
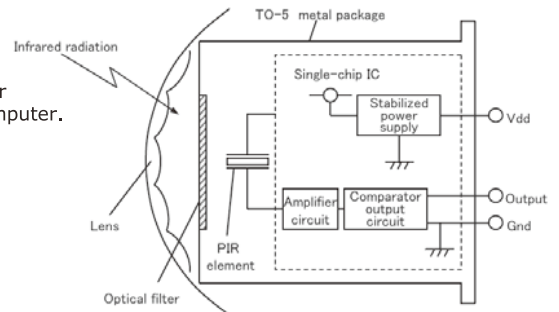

PRODUCT TYPES

Detection Performance	Current Consumption	Lens Color	Model No.	Inner Package	Outer Package
Standard Detection 5m	170 μA	White	EKMC1601111	50pcs	1000pcs
		Black	EKMC1601112		
		Pearl White	EKMC1601113		
Long Distance Detection 12m	170 μA	White	EKMC1603111	50pcs	1000pcs
		Black	EKMC1603112		
		Pearl White	EKMC1603113		

PRODUCT TYPES

1. Detection Performance [Conditions for measuring: Ambient temperature: 25°C(77°F) Operating voltage: 5VDC]

Items		Standard Detection 5m	Long Distance Detection - 12m	Conditions concerning target
Detection Range *1)		Max. 5m	Max. 12m	1. The temperature difference between the target and the surroundings should be superior to 4°C (7.2°F). 2. Movement speed: 1.0m/s 3. Target concept is human body (Size: 700 × 250mm)
Detection Area	Horizontal *2)	94° (±47°)	102° (±51°)	
	Vertical *2)	82° (±41°)	92° (±46°)	
Detection Zone *3)		64 zones	92 zones	

*1) Depending on the target's speed and its temperature difference with the surroundings, detection can occur at a range superior to the above value. However, please use this sensor according to the specifications.

*2) Definitions for "Horizontal" and "Vertical"

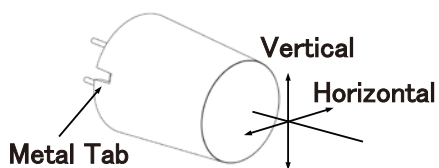

Standard detection type

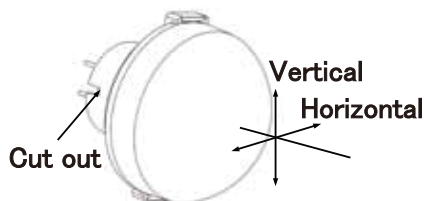

Long Distance detection type

*3) Refer to the "detection area" diagram on P.4.

2. Maximum Rated Values

Items	Specified value
Power Supply Voltage	-0.3~7.0V DC
Usable Ambient Temperature	-20~+60°C (-4~+140°F) Do not use in a freezing or condensation environment.
Storage Temperature	-20~+70°C (-4~+158°F)

3. Electrical Characteristic [Conditions for Measuring: Ambient temperature 25°C(77°F)]

Items		Symbol	VZ series	Measured Conditions
Operating Voltage	Min.	Vdd	3.0V DC	—
	Max.		6.0V DC	—
Electrical Current Consumption	Avg.	Iw	170 μA	Iout=0
	Max.		300 μA	
Output Current	Max.	Iout	100 μA	Vout ≥ Vdd - 0.5
Output Voltage	Min.	Vout	Vdd - 0.5VDC	—
Circuit Stability Time (When voltage is applied)	Avg.	T _{wu}	—	—
	Max.		30s	

TIMING CHART

1. Digital Output

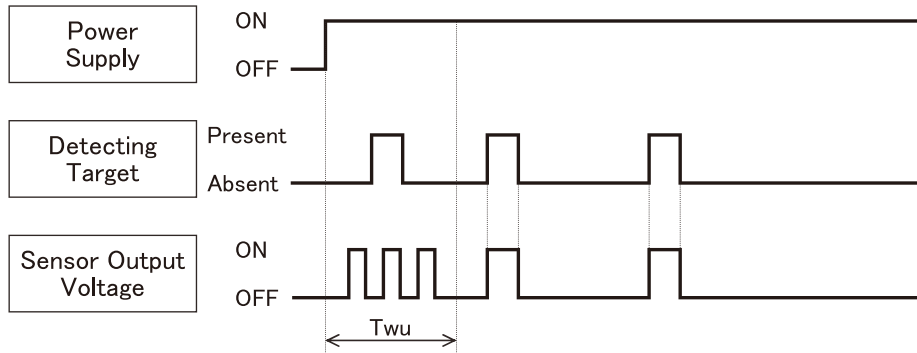

[Durations]

T_{wu} : Circuit Stability Time: About 30s. (Max.)
 During this stage, the output's status is undefined (ON/OFF) and detection is therefore not guaranteed.

DETECTION PERFORMANCE

1) Standard detection type

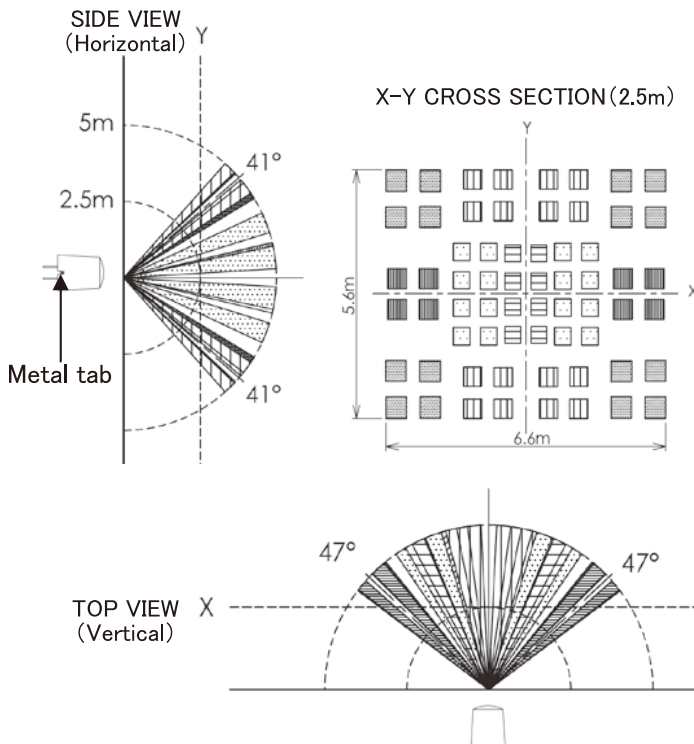

2) Long Distance detection type

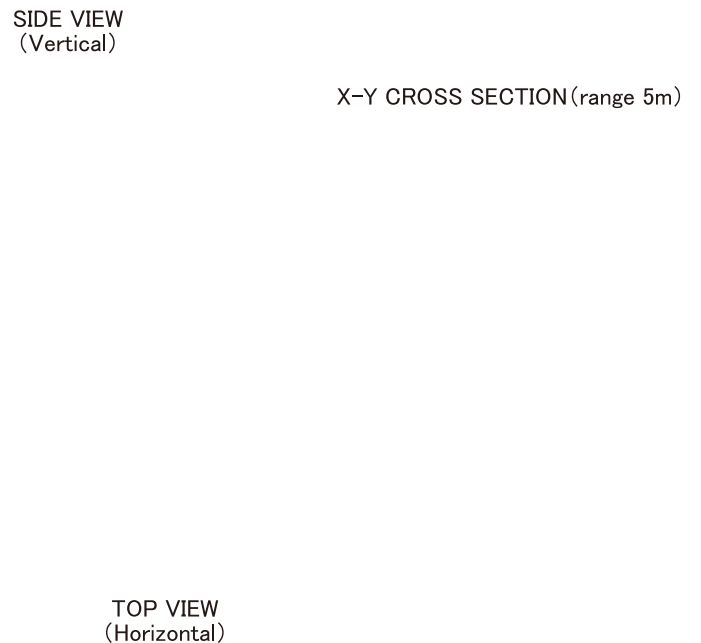

2. Notes Regarding the Detection Zone

As shown on the diagram, the detection zone is polarized.
If a target enters the detection zones + and - at the same time, the signals are respectively cancelled and detection could become impossible at maximum detection range.
(Please refer to the detection area diagram for details)

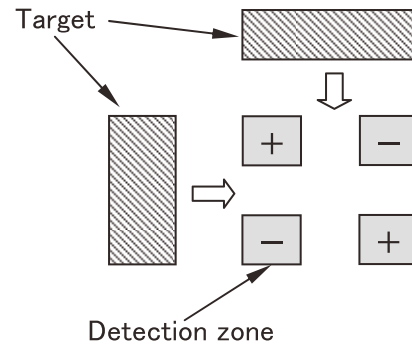

HOW TO USE

1. Wiring Diagram (Digital Output)

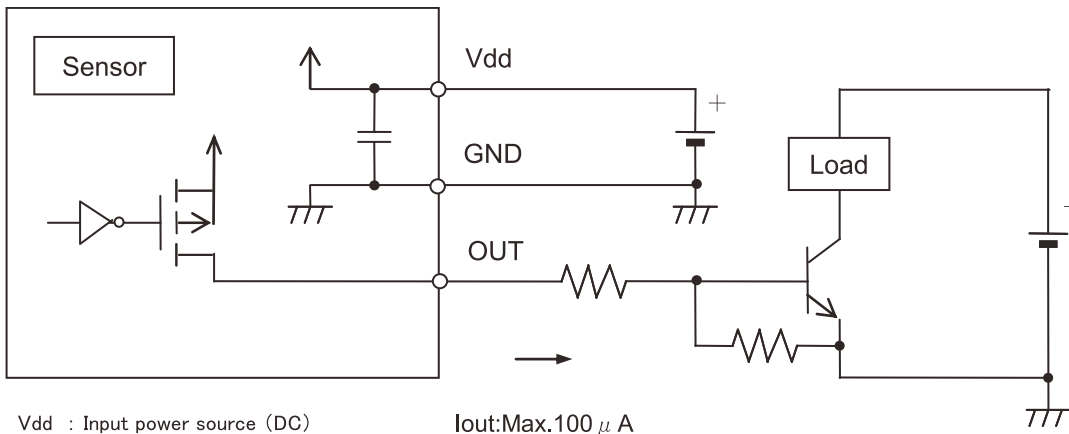

Vdd : Input power source (DC)
GND : GND
Out : Output (Comparator)
Iout:Max.100 μ A

2. Moving Direction Concept

As detailed on the diagram, please install the sensor so that the expected trespassing direction corresponds to the axis X or axis Y.

In some cases, intrusions that occur parallel to the axis Z in every detection zone, closing toward the sensor, may not be detected.

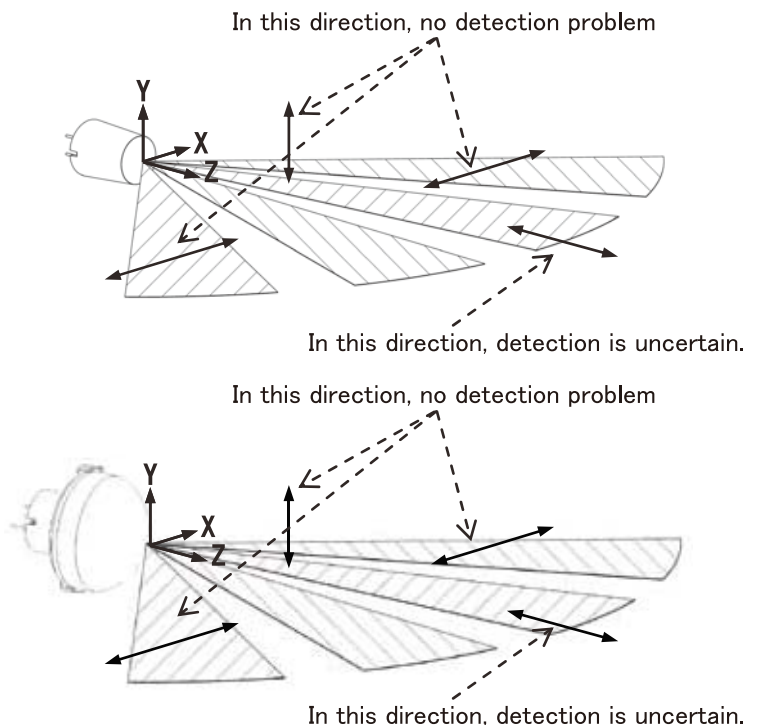

DIMENSION

1) Standard Detection type



A-A Cross Sectional

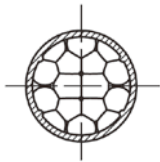

Dimensions

TOP VIEW



SIDE VIEW

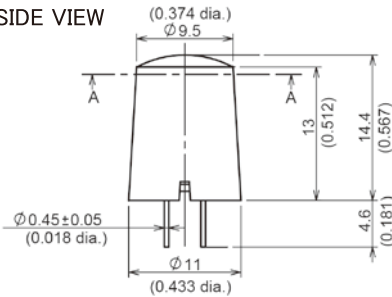

BOTTOM VIEW

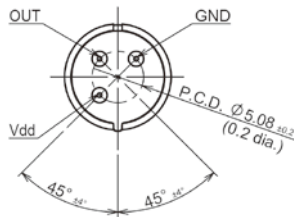

When designing your products

To maintain specified detection capability, please place and expose the sensor so that tip of lens will be more than 1.3mm above the chassis.

The hole of the chassis should have a taper depending on the lens shape, or have a bigger hole.

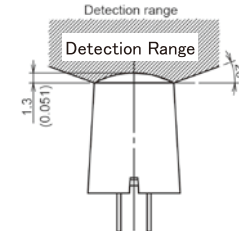

Recommended Hole Drilling Diameter

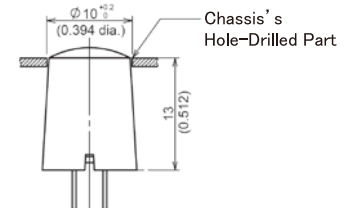

Recommended PCB Pattern Design

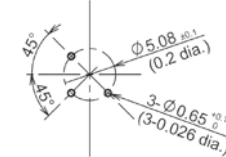

2) Long Distance Detection type



A-A Cross Sectional

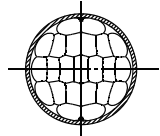

Dimensions

TOP VIEW

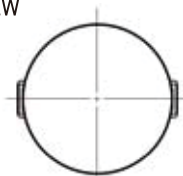

SIDE VIEW

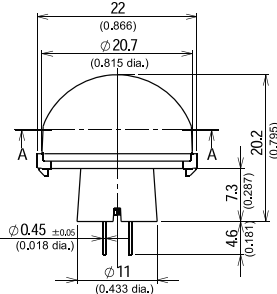

BOTTOM VIEW

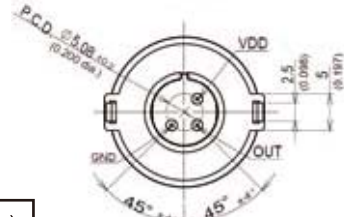

When designing your products

To maintain specified detection capability, please place and expose the sensor so that tip of lens will be more than 7.1mm above the chassis.

The hole of the chassis should have a taper depending on the lens shape, or have a bigger hole.

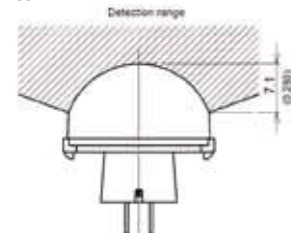

Recommended Hole Drilling Diameter

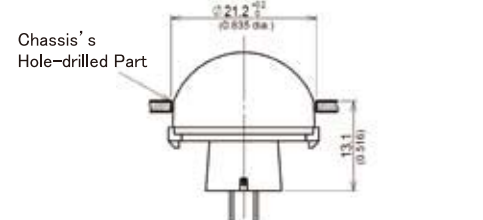

Recommended PCB Pattern Design



General Tolerance $\pm 0.5\text{mm}$ ($\pm 0.020\text{inch}$)

NOTES

1. Basic Principles

The PaPIRS Motion Sensor is a pyroelectric infrared sensor that detects variations in infrared rays. However it may not detect in the following cases: lack of movement, no temperature change in the heat source. Besides, it could also detect the presence of heat sources other than a human body. Efficiency and reliability of the system may vary depending on actual operating conditions:

- 1) Detecting heat sources other than the human body, such as:
 - a) small animals entering the detection area.
 - b) white light source (sunlight, car headlights, etc.) directly hitting the sensor.
 - c) sudden temperature changes in the detection area caused by humidifier water vapor emission, or air conditioning system hot/cold air emissions.
- 2) Difficulty in sensing the heat source
 - a) Glass, acrylic or similar materials standing between the target and the sensor may not allow a correct transmission of infrared rays.
 - b) Non-movement or quick movements of the heat source inside the detection area.
- 3) Expansion of the detection area
In case of considerable difference in the ambient temperature and the human body temperature, detection area may be wider apart from the configured detection area.

3. Ambient Environmental Conditions

- 1) Temperature: Ambient temperature $-20^{\circ}\text{C} \sim +60^{\circ}\text{C}$ ($-4^{\circ}\text{F} \sim +140^{\circ}\text{F}$)
(Do not use in a freezing or condensation environment)
Storage Temperature $-20^{\circ}\text{C} \sim +70^{\circ}\text{C}$ ($-4^{\circ}\text{F} \sim +158^{\circ}\text{F}$)
- 2) Humidity Degree: 15~85% Rh (Avoid condensation or freezing of this product)
- 3) Pressure : 86~106kPa
- 4) Operating "temperatures" and "humidity level" are suggested to prolong usage. However, they do not guarantee durability or environmental resistance. Generally, high temperatures or high humidity levels will accelerate the deterioration of electrical components. Please consider both the planned usage and environment to determine the expected reliability and length of life of the product.
- 5) This sensor is not waterproof or dustproof. Avoid use in environments subject to excessive moisture, condensation, frost, containing salt air or dust. If a sensor is used with a cover installed, the initial detection performance specifications may not be able to be met. Confirm the operation under the actual operating conditions.
- 6) Overheating, oscillations, shocks can cause the sensor to malfunction.

2. Other handling cautions

- 1) Deterioration of detecting performance will happen if dirt and dust adhere to the lens.
- 2) The lens of the Polyethylene lens type is made of soft materials (Polyethylene). If any loads or shocks are applied to the lens, due to deformities, and damages, this will lead to malfunction, or deterioration of performance.
- 3) The sensor may be damaged by ± 200 volts of static electricity. Avoid direct hand contact with the pins and be very careful when operating the product
- 4) When soldering the lead wire, hand solder the sensor using the soldering iron below 350°C , and within 3 seconds. Please avoid soldering using solder tank, this can lead to deterioration of performance. Also please avoid bending the lead wire to mount the sensor on to the circuit board temporarily. This will damage the sensor.
- 5) Do not use liquids to wash the sensor. If washing fluid gets through the lens, it can reduce performance.
- 6) When wiring the product, always use shielded cables and minimize the wiring length to prevent noise disturbances.

4. External surge voltages

The inner circuit board could be destroyed by a voltage surge. Use of surge absorption elements is highly recommended.
>Surge resistance : below the power supply voltage value indicated in the maximum rated values section.

5. Power supply-superimposed noise

- 1) Please use a stabilized power supply. Power supply noise can cause operating errors.
>Noise resistance : $\pm 20\text{V}$ or less (Square waves with a width of 50ns or 1 μs)
- 2) To reduce the effect of power supply noise, install a capacitor on the sensor's power supply pin.

6. Drop damage

After the sensor had been dropped on the floor, the damage can occur resulting in incorrect operation. Therefore, be sure not to use those sensors.

**Safety Precautions**

Head the following precautions to prevent injury or accidents.

- 1) Do not use these sensors under any circumstance in which the range of their ratings, environment conditions or other specifications are exceeded. Using the sensors in any way which causes their specifications to be exceeded may generate abnormally high levels of heat, emit smoke, etc., resulting in damage to the circuitry and possibly causing an accident.
- 2) Our company is committed to making products of the highest quality and reliability. Nevertheless, all electrical components are subject to natural deterioration, and durability of a product will depend on the operating environment and conditions of use. Continued use after such deterioration could lead to overheating, smoke or fire. Always use the product in conjunction with proper fire-prevention, safety and maintenance measures to avoid accidents, reduction in product life expectancy or break-down.
- 3) Before connecting, check the pin layout by referring to the connector wiring diagram, specifications diagram, etc., to verify that the connector is connected properly. Mistakes made in connection may cause unforeseen problems in operation, generate abnormally high levels of heat, emit smoke, etc., resulting in damage to the circuitry.
- 4) Do not use any motion sensor which has been disassembled or remodeled.
- 5) Failure modes of sensors include short-circuiting, open-circuiting and temperature rises. If this sensor is to be used in equipment where safety is a prime consideration, examine the possible effects of these failures on the equipment concerned, and ensure safety by providing protection circuits or protection devices.
Example :
 - Safety equipments and devices
 - Traffic signals
 - Burglar and disaster prevention