

Products for tomorrow...



Description

Magnetically operated Reed Sensors in flat form with mounting holes for screw fastening

Applications

Position and limit switch
Door and window contact
Level sensor

Features

Choice of switches, termination options, & cable lengths
5 ranges of switch sensitivity

Dimensions

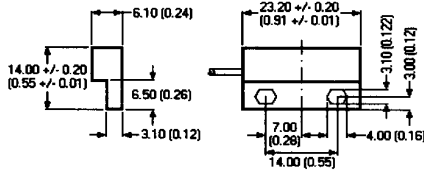

Tolerance +/- 0.10 mm (0.004 in)

Termination

The standard termination is a 2-wire flat cable with a cross section of 2x0.14mm². The standard cable length is 500 mm, other lengths can be supplied on request. The required length must be stated in the part number. The cable end can be supplied with the following connection styles:

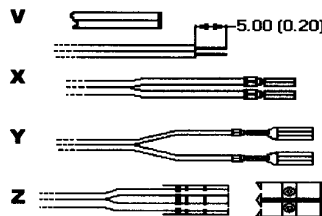

V Standard flat cable straight cut only
X Standard flat cable with 5 mm (0.2 in) Individual crimped terminals 1 mm (0.04 in) diameter
Y Individual spade terminals 2.8 x 0.8 mm (0.11 x 0.03 in)
Z PCB edge connector "MASCON" with 2.54 mm (0.1 in) spacing

Ordering Information

Series	Contact Type	Magnetic Sensitivity	Cable Length (mm)	Termination
MK4	XXXX	X -	XXX	X
	1A71	(AT)	500 standard	(V/W/X/Y/Z)
	1A84			
	1C90	B 10 - 15 (71 only) C 15 - 20 D 20 - 25 E 25 - 30		

All data at 20 °C

Parameter	Conditions	Sym.	Contact 71			Contact 84			Contact 90			Units
			Min	Typ	Max	Min	Typ	Max	Min	Typ	Max	
			Standard Form 1A			High Dielectric Form 1A			Standard Form C Form 1C			
Contact Operation												
Must operate condition	Steady state field (ranges available)		10		30	15		30	15		30	AT
Must release condition	Steady state field (ranges available)		3		30	3		30	3		30	AT
Contact Ratings												
Rated Power	DC/peak AC Resistive	W			10			10			3	Watts
Switching Voltage	DC/peak AC Resistive	V			180*			250			175	Volts
Switching Current	DC/peak AC Resistive	A			0.5			0.5			0.25	Amps
Carry Current	DC/peak AC Resistive	A			1.5**			1.5			1.2	Amps
Static Contact Res.	50mV @ 10mA @ nom. volt.	CR			150			150			150	mΩ
Dynamic Contact Res.	0.5 V @ 50mA, 100 Hz and after 1.5 ms @ nom. volt.	DCR			200			200			na	mΩ
Dielectric Strength	Across contact		250			700			200			DCV
Capacitance	Across switch			0.2			0.2			0.3		pf
Operating time	Including bounce	Top			500			700		700	1000	μs
Release time	No coil suppression	Trel			50			50			2000	μs
Insulation Resistance	Across switch	IR	10 ¹⁰	10 ¹²		10 ¹⁰	10 ¹¹		10 ⁹	10 ¹¹		Ω
Environmental Ratings												
Operating temperature		To	-20		85	-20		85	-20		85	°C
Storage temperature		Ta	-35		85	-35		85	-35		85	°C
Shock	At 11 ms +/- 1ms; 1/2 sine wave	S			150			50			50	Gs
Vibration	10 Hz to 2000 Hz	G			10			35			30	Gs

* Range D and E: 200 V

** Range D and E: 1.75 A

Products for tomorrow...



11

CONTROLS & SENSORS

Description

Magnetically operated Reed Sensors for direct pcb mounting

Features

Magnetic pull-in/drop-out sensitivity is divided into various AT ranges
2.54 mm (1 in) pcb pin to pin on center distance, available with different distances

Applications

Telecommunications
Domestic appliances
Limit switch for low-power signals
Lifts/elevators

Ordering Information

MK6 - 4 X
Series Magnetic Sensitivity

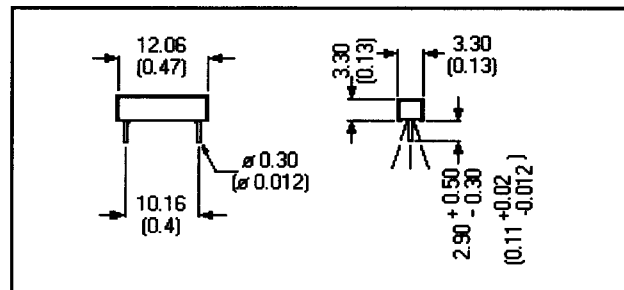

Tolerance +/- 1.0 mm (0.004 in)
Other sizes available

Parameter	Conditions	Sym.	Contact type			Units
			Contact form			
			Min	Typ	Max	
Contact Operation			Contact 84			
			Standard			
			Form 1A			
Must operate condition	Steady state field (ranges available)					AT
Must release condition	Steady state field (ranges available)					AT
Contact Ratings						
Rated Power	DC/peak AC Resistive	W			1	Watts
Switching Voltage	DC/peak AC Resistive	V			100	Volts
Switching Current	DC/peak AC Resistive	A			0.5	Amps
Carry Current	DC/peak AC Resistive	A			0.5	Amps
Static Contact Res.	50 mV @ 10mA @ nom. volt.	CR			150	mΩ
Dynamic Contact Res.	0.5 V @ 50mA, 100 Hz and after 1.5 ms @ nom. volt.	DCR			200	mΩ
Dielectric Strength	Across contact		250			DCV
Capacitance	Across switch			0.2		pf
Operating time	Including bounce	Top			500	μs
Release time	No coil suppression	Trel			50	μs
Insulation Resistance	Across switch	IR	10 ¹⁰	10 ¹²		Ω
Contact material				Ru		
Environmental Ratings						
Operating temperature		To	-20		85	°C
Storage temperature		Ta	-35		85	°C
Shock	At 11 ms +/- 1 ms; 1/2 sine wave	S			150	Gs
Vibration	10 Hz to 2000 Hz	G			10	Gs

Products for tomorrow...



Description

Magnetically operated proximity sensors for SMT mounting

Applications

- A no energy consuming sensor
- Telecommunications applications
- In microphones as switching element
- Sensing flip in cellular phones
- Level sensing
- Proximity sensing

Features

- Lead design 1:**
Flat, straight leads for PCB slot mounting
- Lead design 2:**
Flat, bent SMT leads for SMT mounting
- Sensors delivered in commercial tapes according to IEC 286/part 3 and can be mounted automatically
- Magnetic pull-in sensitivity is divided into several classes in 5 AT steps
- MK15, 16 have simple internal structure, small dimensions, and low cost

Tolerance +/- 0.10 mm (0.004 in)

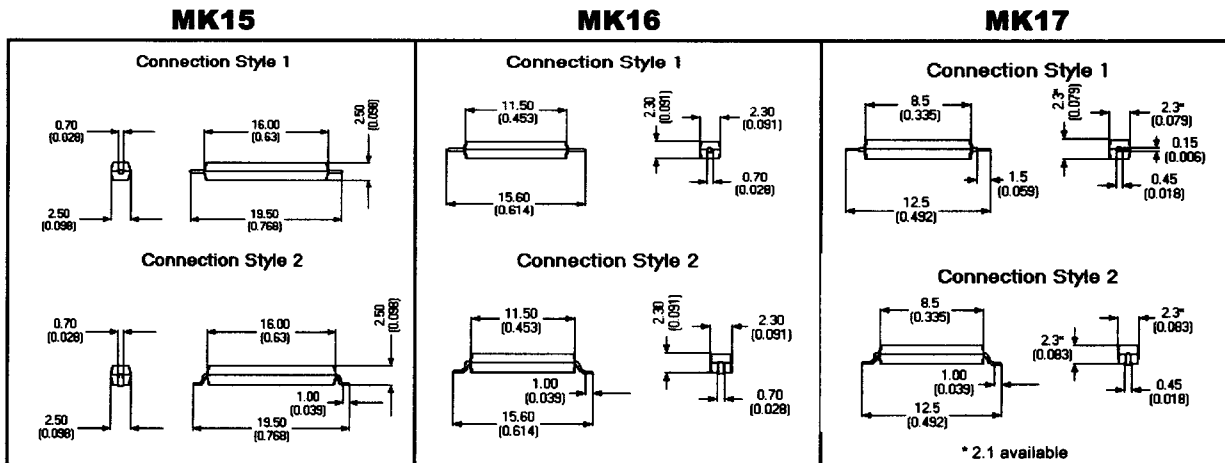

Tape, Reel, and Packaging

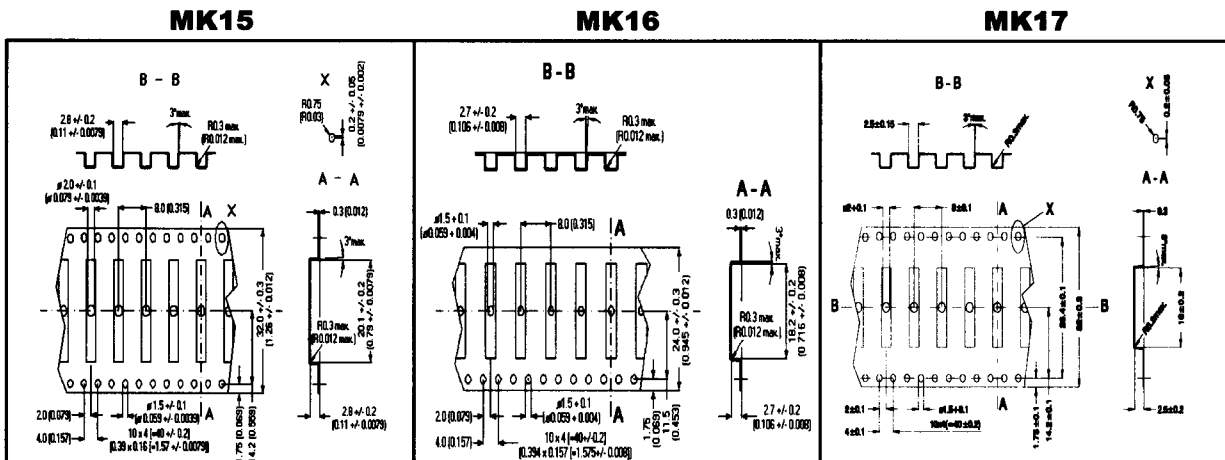

Products for tomorrow...

11

CONTROL & SENSORS



All data at 20 °C

Contact type
Contact form

Parameter	Conditions	Sym.	Contact 71 (MK15)			Contact 87 (MK16)			Contact 39 (MK17)			Units
			Standard			Standard			Standard			
			Min	Typ	Max	Min	Typ	Max	Min	Typ	Max	
Contact Operation												
Must operate condition	Steady state field (ranges available)	AT	10		30	10		30	10		30	AT
Must release condition	Steady state field (ranges available)	AT	3		30	3		30	3		30	AT
Contact Ratings												
Rated Power	DC/peak AC Resistive	W			10			1			10	Watts
Switching Voltage	DC/peak AC Resistive	V			180*			24			100	Volts
Switching Current	DC/peak AC Resistive	A			0.5			0.1			0.5	Amps
Carry Current	DC/peak AC Resistive	A			1.5**			0.3			1	Amps
Static Contact Res.	50mV @ 10mA @ nom. volt.	CR			150			150			150	mΩ
Dynamic Contact Res.	0.5 V @ 50 mA, 100 Hz and after 1.5 ms @ nom. volt.	DCR			200			200			200	mΩ
Dielectric Strength	Across contact											DCV
Capacitance	Across switch											pf
Operating time	Including bounce	Top			500			500			400	μs
Release time	No coil suppression	Trel			50			50			50	μs
Insulation Resistance	Across switch	IR	10 ¹⁰	10 ¹²		10 ¹⁰	10 ¹²		10 ¹⁰	10 ¹²		Ω
Environmental Ratings												
Operating temperature		To	-20		130	-20		130	-20		70	°C
Storage temperature		Ta	-35		130	-35		130	-20		70	°C
Shock	At 11 ms +/- 1ms; 1/2 sine wave	S			50			50			50	Gs
Vibration	10 Hz to 2000 Hz	G			10			10			10	Gs

* Range D and E: 200 V

** Range D and E: 1.75 A





Ordering Information

XXXX-	X-	X
Series	Magnetic Sensitivity	Lead Design
MK15	(AT)	
MK16	B 10 - 15	Style 1 - 1
MK17	C 15 - 20	Style 2 - 2
	D 20 - 25	
	E 25 - 30	

Products for tomorrow.

11

CONTROLS & SENSORS

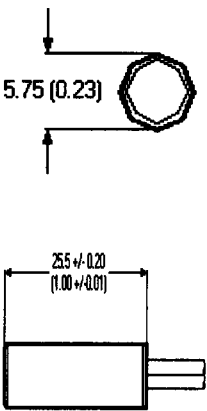
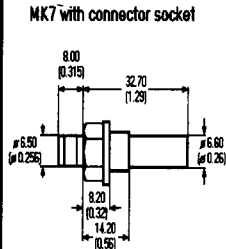
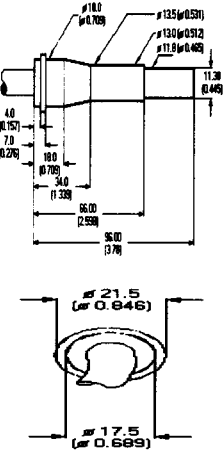
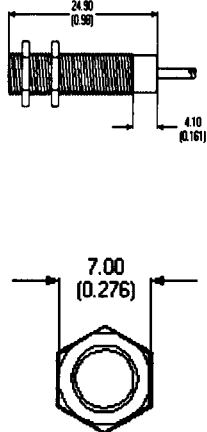
				
	MK3 Series Cylindrical magnetically operated Reed Sensors	MK7 Series Magnetically operated Reed Sensors in cylindrical form with M8 thread	MK8 Series Oil-resistant Reed Sensor with intrinsically safe approval	MK11 Series Magnetically operated Reed Sensors with screw thread enclosure
DIMENSIONS Tolerance 0.10 mm (0.004 in) except as noted		 MK7 with connector socket Version with cable available		
FEATURES	Series offers a selection of two-part magnetically operated reed proximity switches Five ranges of switch sensitivity are offered Ideal for ring type magnet on end-on actuation	Series offers a selection of two-part magnetically operated reed proximity switches Five ranges of switch sensitivity are offered	Magnetically actuated Oil resistant cable Six ranges of switch sensitivity are offered, allowing a wide range of sensor-magnet distances for customer applications	Non-corrosive stainless steel housing for exact adjusting Magnetic pull-in sensitivity is divided in several AT classes at 5 AT steps each Different types of switches, connections, and cable lengths available
APPLICATIONS	Position and limit switch Door and window contact for security systems Level sensor	Position and limit switch Level sensor Position sensor	Position and limit switch Impulse or revolution sensing Petro industry Cold resistant	Position and limit switch End position sensing Machinery safety and control
SPECS	Contact style Operating temp (°C) Storage temp (°C) Operating time (µs) Release time (µs) Rated power (Watts) Avail. operate range (AT)	1A, 1B, 1C -20 / 85 -35 / 85 500 - 2000 100 - 1000 3 - 10 5 - 30	1A, 1B, 1C -20 / 85 -35 / 85 500 - 1000 100 - 1000 3 - 12 5 - 30	1A -20 / 85 -35 / 85 500 100 5 - 15 5 - 30