

Slide Switch - Horizontal & Vertical Operation

**NEW
PRODUCTS**

- **Features** Minature Slide Switch in Horizontal, Vertical, SMD Types
2 mm Travel, 3.5 mm in Body Height, 2 mm Knob Length
Available in SPDT, DPDT, SP3T, DP3T Configurations

S SSS2 - □ □ - □ □

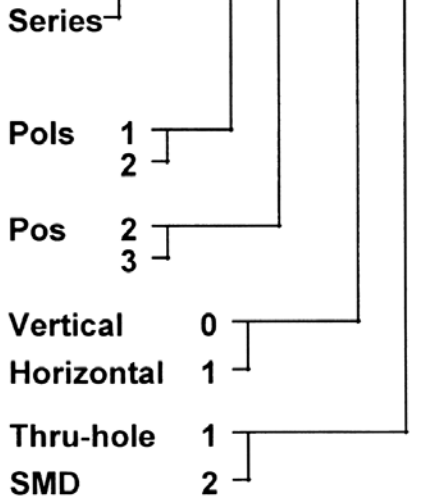

Rating: 0.3 A 6 vdc
(resistive load)

Operation Force: 200 ± 150 gF

Operating Life Without Load:
10,000 Cycles

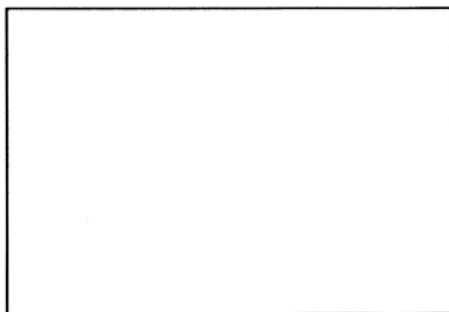
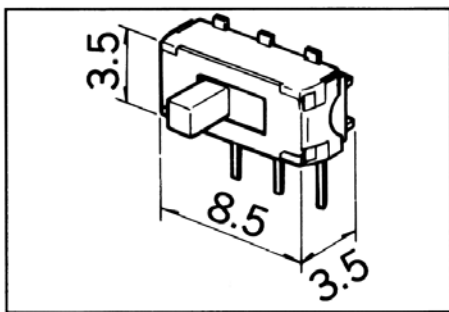

Horizontal Type (Thru-hole)

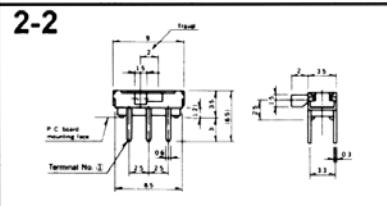
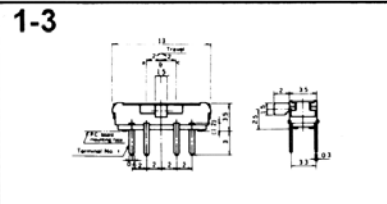
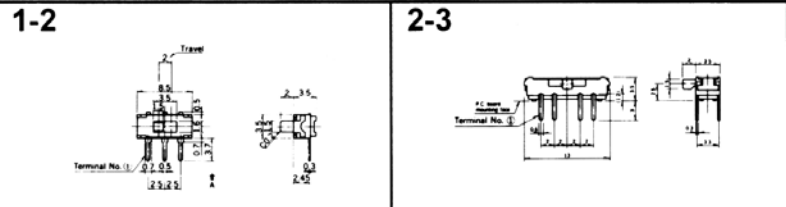

Vertical Type (Thru-hole)

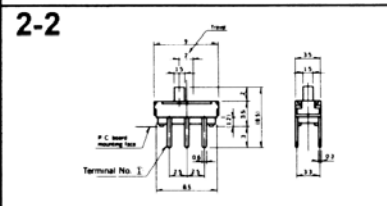
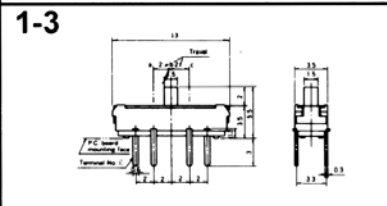
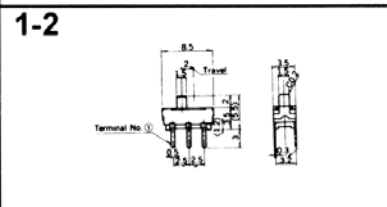

SMD Types **NEW**

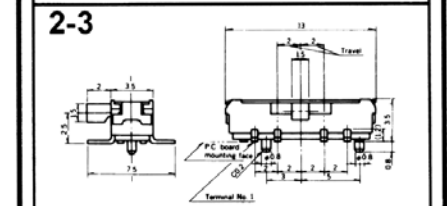
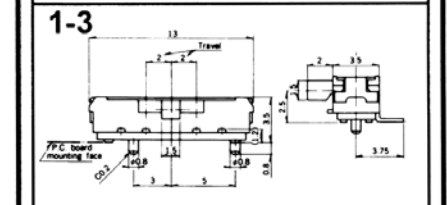
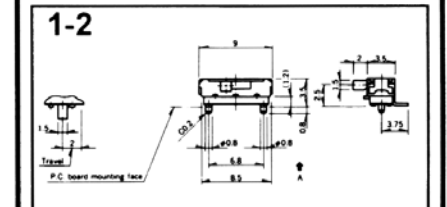

See T/R packaging note below

SMD Type available in T/R packaging ONLY. 1,400 pcs. per reel, 5,600 pcs. per case. Reel Dimensions: 24 mm wide embossed tape, Reel width 24.4 mm, Reel diameter 370~380 mm, Spindle hole 13 mm.