

SA1E Sensors



Highlights:

- Fully automated assembly
- High-speed response
- Subminiature design
- Cable and M8 Quick connector models available
- IP67 rated

Available Sensing Modes:

Through-beam (Class 1 Laser)	Pg 3
Polarized retro-reflective (Class 1 Laser)	Pg 4
Background suppression (Class 1 Laser)	Pg 5
Convergent	Pg 6
Diffuse	Pg 7
Small-beam reflective	Pg 8
Transparent	Pg 9

Photoelectric sensors

Photoelectric sensors send a beam of light to detect the presence of target objects, generally utilizing an emitter and receiver for this function. Photoelectric technology is ideal for industries such as material handling, packaging, electronics and semiconductor manufacturing, food and beverage, and pharmaceutical.

IDEC SA1E photoelectric sensors

Accurate detection of target objects is imperative for control systems. With reliable object detection and repeatability, you can have fewer false alarms and less product rejection. Designed to function consistently over time and tolerate harsh industrial environments, the IDEC SA1E photoelectric sensors are completely assembled using precise robotic technology to produce a reliable, accurate and durable product. No matter how demanding your application is, there's an SA1E photoelectric sensor with the features to suit your requirements and a low price to fit your budget!

SA1E photoelectric sensors come in an easy-to-install, compact housing with a choice of NPN or PNP outputs, as well as a choice of operation modes. In Light ON mode, the output is energized when the sensor detects light. In Dark ON mode, the output is energized when the sensor detects dark (the absence of light).



Through-beam

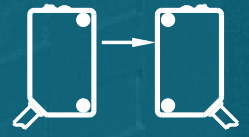

www.IDEC.com/sensor

Benefits of through-beam sensors:

- Suitable for dirty environments
- Offers precise detection
- Detects target objects up to 30 meters away (laser models)

IDEC SA1E through-beam photoelectric sensors are configured with the emitter and detector placed facing each other, perpendicular to the path of the target object. Light is sent from the emitter to the receiver, and the target object is detected when the beam is broken.



Through-beam

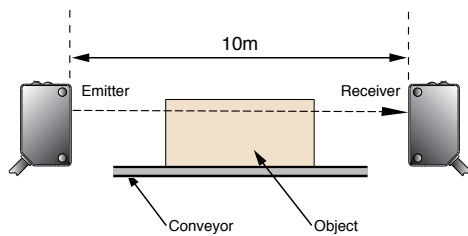

Sensing Method	Sensing Range	Connection	Cable Length	Operation Mode	Part Number	
					NPN Output	PNP Output
Through-Beam Infrared LED	10m*	Cable	2m	Light ON	SA1E-TN1-2M	SA1E-TP1-2M
				Dark ON	SA1E-TN2-2M	SA1E-TP2-2M
		M8 Connector	2m or 5m (Order Separately)	Light ON	SA1E-TN1C	SA1E-TP1C
				Dark ON	SA1E-TN2C	SA1E-TP2C
Through-Beam Class 1 Laser	30m	Cable	2m	Light ON/Dark ON	SA1E-LTN3-2M	SA1E-LTP3-2M
		M8 Connector	—	Light ON/Dark ON	SA1E-LTN3C	SA1E-LTP3C

*Without Sensitivity Adjustment: 1. SA1E-TN2-NA-2M, 2. SA1E-TP2-NA-2M (15 meter range)

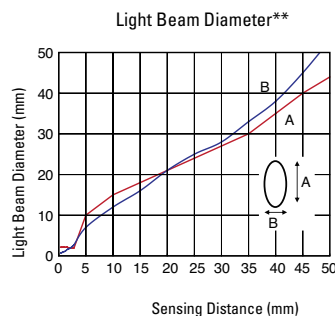
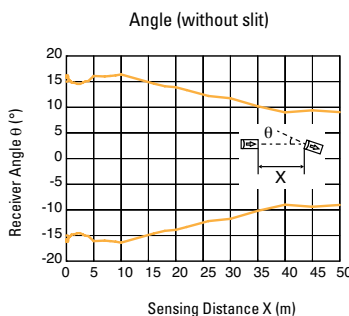
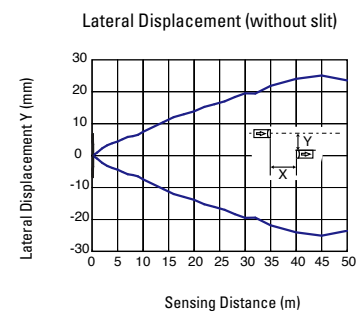
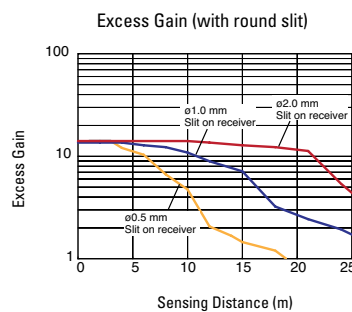
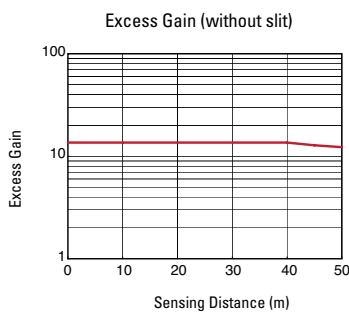

800.262.4332

**Sensing distance below 3 m: Defined as 1/e² (13.5%) of the center intensity
Sensing distance over 3 m: Reference value (visual inspection)

Polarized retro-reflective

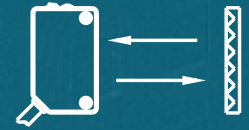

Benefits of polarized retro-reflective sensors:

- Emitter and detector in one unit
- Polarized beam detects matte and mirrored objects
- Detects reflective objects

IDEC SA1E polarized retro-reflective sensors are configured with the emitter and detector housed in one unit. Light is sent from the sensor's emitter to a reflector, which then reflects the light back to the sensor's receiver. The biggest advantage of using this type of sensor is that wiring is very easy due to the fact you only have one unit to wire. These sensors are also ideal for detecting mirror-like objects.



Polarized retro-reflective

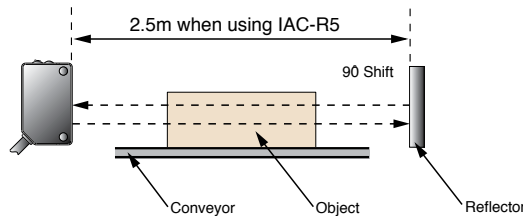

Sensing Method	Sensing Range	Connection	Cable Length	Operation Mode	Part Number	
					NPN Output	PNP Output
Polarized Retro-reflective Red LED	2.5m when using IAC-R5	Cable	2m	Light ON	SA1E-PN1-2M	SA1E-PP1-2M
	2.5m when using IAC-R8			Dark ON	SA1E-PN2-2M ¹	SA1E-PP2-2M ²
	1.5m when using IAC-R6	M8 Connector	2m or 5m (Order Separately)	Light ON	SA1E-PN1C	SA1E-PP1C
	1.0m when using IAC-RS1 1.3m when using IAC-RS2 0.8m when using IAC-R7			Dark ON	SA1E-PN2C	SA1E-PP2C
Polarized Retro-reflective Class 1 Laser w/Sensing Range Adjustment	10m	Cable	2m	Light ON/Dark ON	SA1E-LPN3-2M	SA1E-LPP3-2M
		M8 Connector	—		SA1E-LPN3C	SA1E-LPP3C

Without Sensitivity Adjustment: 1. SA1E-PN2-NA-2M, 2. SA1E-PP2-NA-2M

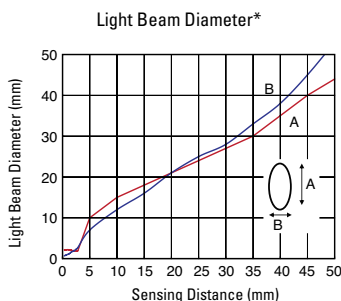
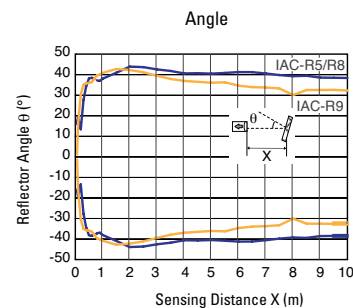
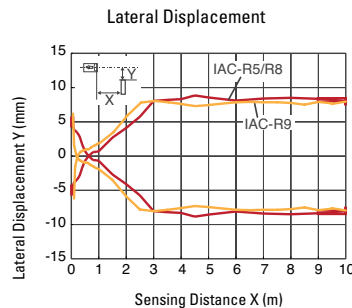
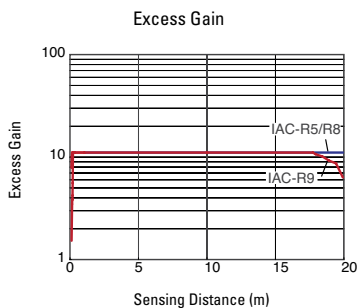

*Sensing distance below 3 m: Defined as $1/e^2$ (13.5%) of the center intensity
Sensing distance over 3 m: Reference value (visual inspection)

800.262.4332

Background suppression

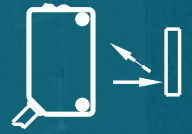

www.IDEC.com/sensor

Benefits of background suppression (fixed field) sensors:

- Reliable object recognition
- Fewer false alarms and product rejections
- Higher level of precision and repeatability

IDEC SA1E background suppression sensors determine the presence of target objects based on a predetermined sensing distance. This means objects beyond the cut-off range won't be detected, and ensures that target objects can be accurately and reliably detected regardless of color or reflectivity.



Background suppression

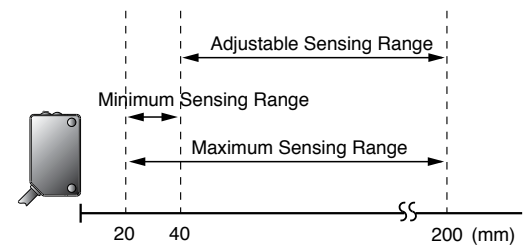
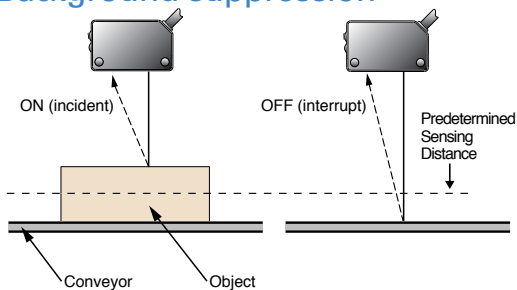

Sensing Method	Sensing Range	Connection	Cable Length	Operation Mode	Part Number	
					NPN Output	PNP Output
Background suppression Red LED w/Sensing Range Adjustment	20 to 200mm (Adjustable Sensing Range 40 to 200mm)	Cable	2m	Light ON	SA1E-BN1-2M	SA1E-BP1-2M
				Dark ON	SA1E-BN2-2M	SA1E-BP2-2M
		M8 Connector	2m or 5m (Order Separately)	Light ON	SA1E-BN1C	SA1E-BP1C
				Dark ON	SA1E-BN2C	SA1E-BP2C
Background suppression Class 1 Laser w/Sensing Range Adjustment	20 to 300mm (Adjustable Sensing Range 40 to 300mm)	Cable	2m	Light ON/Dark ON	SA1E-LBN3-2M	SA1E-LBP3-2M
		M8 Connector	-	Light ON/Dark ON	SA1E-LBN3C	SA1E-LBP3C

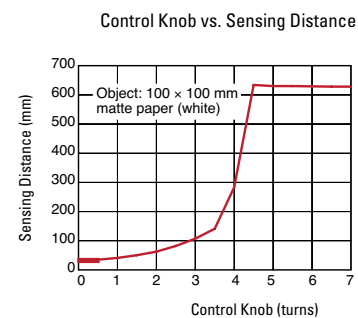
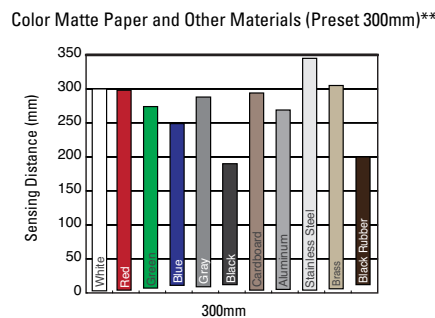
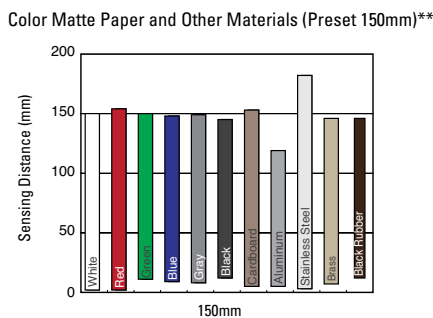
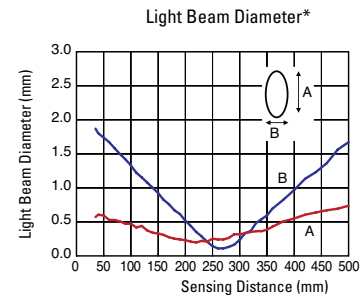
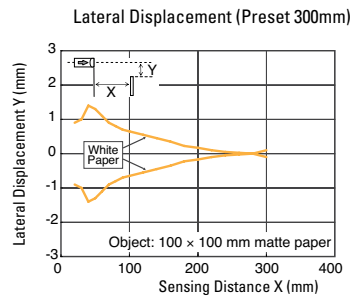
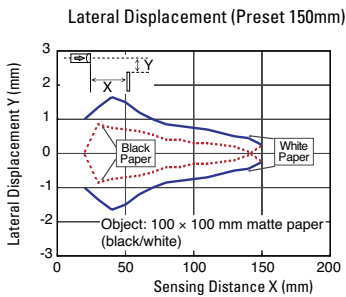

*Light beam diameter: Defined as 1/e2 (13.5%) of the center intensity

**Comparison of sensing distance when set to detect white matte paper (100 x 100 mm)

Convergent

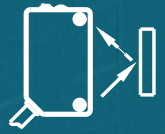

Benefits of convergent (point focus) sensors:

- Ideal for objects with low reflectivity and varying colors
- Reliable detection of objects with a small profile
- Accurate short distance sensing, while ignoring the background

IDEA SA1E convergent sensors focus the emitter and receiver to an exact point in front of the sensor. This method of sensing provides an intense and well-defined sensing area. This allows for detection of transparent objects.

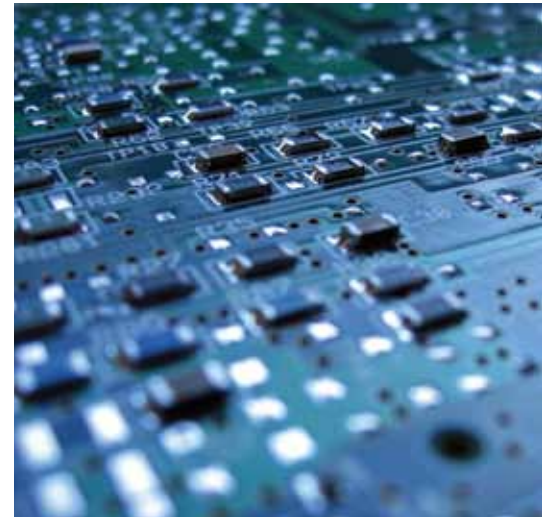

Convergent

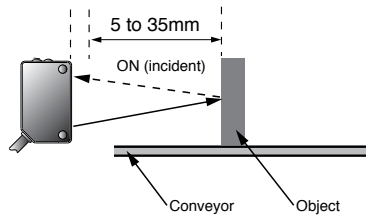

Sensing Method	Sensing Range	Connection	Cable Length	Operation Mode	Part Number	
					NPN Output	PNP Output
Convergent Infrared LED	5 to 35mm	Cable	2m	Light ON	SA1E-GN1-2M	SA1E-GP1-2M
				Dark ON	SA1E-GN2-2M	SA1E-GP2-2M
		Connector	2m or 5m (Order Separately)	Light ON	SA1E-GN1C	SA1E-GP1C
				Dark ON	SA1E-GN2C	SA1E-GP2C

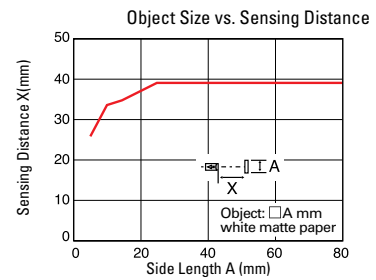
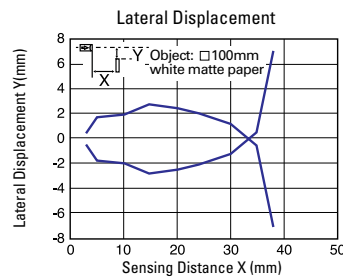
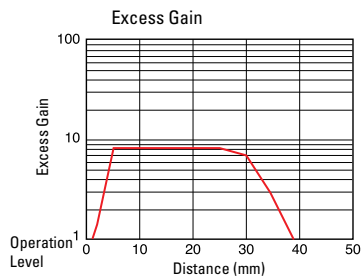

Diffuse-reflective

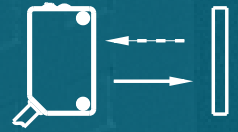

www.IDEC.com/sensor

Benefits of diffuse-reflective sensors:

- Emitter and detector in one unit
- Easy alignment and a 700mm maximum sensing range
- Detects transparent or translucent objects

IDEC SA1E diffuse-reflective sensors have the emitter and receiver built into a single unit that allows these sensors to rely upon reflection from the surface of the target object. Light is sent from the sensor's emitter to the target objects and bounced back to the sensor's receiver. Diffuse sensing is the premiere choice for materials that are translucent to light. These sensors are also ideal for many types of applications because they are easy to setup and use. You only need to wire one unit and there is no need for a separate receiver or reflector.



Diffuse-reflective

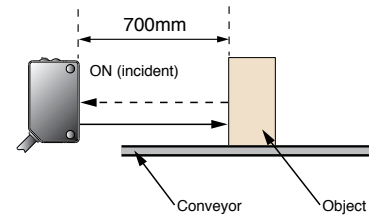

Sensing Method	Sensing Range	Connection	Cable Length	Operation Mode	Part Number	
					NPN Output	PNP Output
Diffuse-reflective Infrared LED	700mm	Cable	2m	Light ON	SA1E-DN1-2M	SA1E-DP1-2M
				Dark ON	SA1E-DN2-2M	SA1E-DP2-2M
		M8 Connector	2m or 5m (Order Separately)	Light ON	SA1E-DN1C	SA1E-DP1C
				Dark ON	SA1E-DN2C	SA1E-DP2C

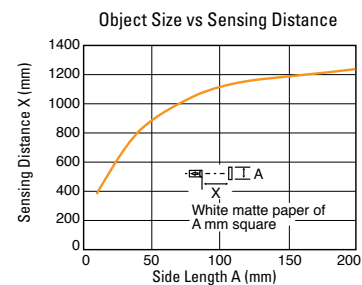
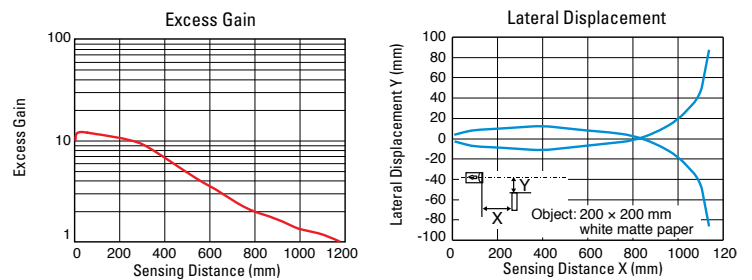

800.262.4332

Small-beam reflective

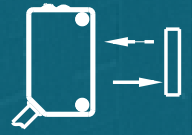

Benefits of small-beam reflective sensors:

- Emitter and detector in one unit
- Narrow beam ignores objects around target
- Detects small objects

IDEC SA1E small-beam reflective sensors operate like diffuse-reflective, the emitter and receiver are contained in the same housing. However, the small light beam generated by these sensors can reach a target in a narrow space at a distance up to 150mm. This makes them an ideal sensor for detecting very small objects, within a narrow field of vision.



Small-beam reflective

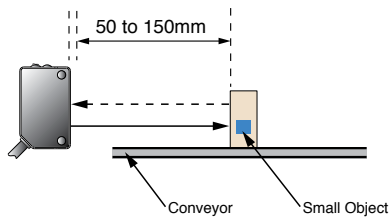

Sensing Method	Sensing Range	Connection	Cable Length	Operation Mode	Part Number	
					NPN Output	PNP Output
Small-Beam Reflective Red LED	50 to 150mm	Cable	2m	Light ON	SA1E-NN1-2M	SA1E-NP1-2M
				Dark ON	SA1E-NN2-2M	SA1E-NP2-2M
		M8 Connector	2m or 5m (Order Separately)	Light ON	SA1E-NN1C	SA1E-NP1C
				Dark ON	SA1E-NN2C	SA1E-NP2C

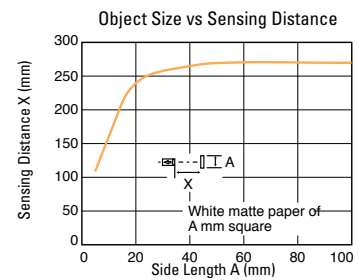
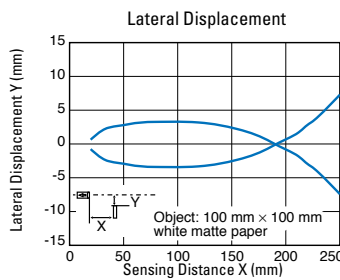
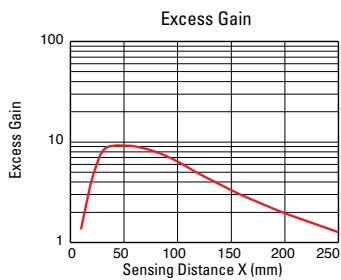

Transparent

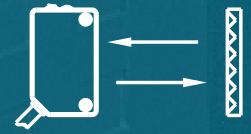

www.IDEC.com/sensor

Benefits of transparent sensors:

- Ideal for transparent, opaque, mirror-like objects
- Long sensing range - up to 2m
- Quick reponse time - 500 μ s

IDEC SA1E transparent Class1 laser sensors feature a coaxial optic and narrow beam to ensure stable detection. They can reliably solve challenging applications such as sensing of plastic, glass and other transparent bottles, transparent film for packaging, and wafer displacement.



Transparent

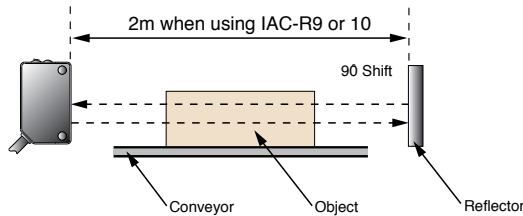

Sensing Method	Sensing Range	Connection	Cable Length	Operation Mode	Part Number	
					NPN Output	PNP Output
Coaxial Polarized Retro-reflective Red LED w/Sensitivity Adjustment	2m when using IAC-R9 2m when using IAC-R10 1m when using IAC-R11	Cable	2m	Light ON	SA1E-XN1-2M	SA1E-XP1-2M
				Dark ON	SA1E-XN2-2M	SA1E-XP2-2M
		M8 Connector	-	Light ON	SA1E-XN1C	SA1E-XP1C
				Dark ON	SA1E-XN2C	SA1E-XP2C

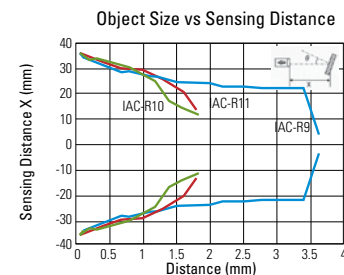
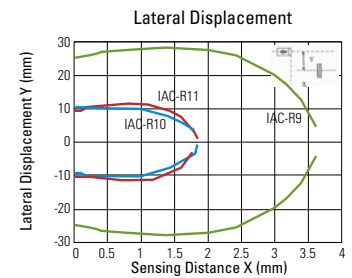
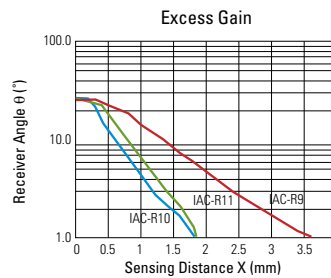

800.262.4332

Accessories

Reflectors (for polarized retro-reflective sensors)

Item		Part Number
	Standard reflector	IAC-R5
	Small reflector	IAC-R6
	Large reflector	IAC-R8
	Narrow (rear/side mounting)	IAC-R7M
	Narrow (side mounting)	IAC-R7S
	Narrow (rear mounting)	IAC-R7B
	Tape (35 x 40mm)	IAC-RS1
	Tape (70 x 80mm)	IAC-RS2
	Standard	IAC-R9*
	Small	IAC-R10*
	Ultra-small	IAC-R11*

*for use with SA1E-X Brackets



Mounting Brackets

Item		Part Number
	Vertical mounting bracket	SA9Z-K01
	Horizontal mounting bracket	SA9Z-K02
	Cover mounting bracket	SA9Z-K03
	Back mounting bracket	SA9Z-K04
	Reflector mounting bracket	IAC-L2
	Reflector mounting bracket	IAC-L3
		IAC-L5

Slits (for through-beam sensors)

Item	Slit Size	Part Number	Min. Order Qty	
	Vertical slit	0.5mm x 18mm	SA9Z-S06	
		1.0mm x 18mm	SA9Z-S07	
		2.0mm x 18mm	SA9Z-S08	
	Horizontal slit	0.5mm x 6.5mm	SA9Z-S09	2
		1.0mm x 6.5mm	SA9Z-S10	
		2.0mm x 6.5mm	SA9Z-S11	
	Round slit	ø0.5mm	SA9Z-S12	
		ø1.0mm	SA9Z-S13	
		ø2.0mm	SA9Z-S14	

Connector Cables (for connector model sensors)

Item	Number of Core Wires	Type & Length	Part Number
	4	Straight, 2m	SA9Z-CM8K-4S2
		Straight, 5m	SA9Z-CM8K-4S5
		Right angle, 2m	SA9Z-CM8K-4L2
		Right angle, 5m	SA9Z-CM8K-4L5

Air Blower Mounting Blocks

Appearance	Item	Part Number
	Air blower mounting block	SA9Z-A02

Sensitivity Control Screwdriver

Item	Part No.	Package Quantity
Sensitivity Control Screwdriver	SA9Z-AD01	1
		

800.262.4332

www.IDEC.com/sensor

Technical Specifications

Sensing Method	Through-beam	Polarized Retro-reflective	Diffuse-reflective	Small-beam Reflective	Background Suppression (BGS)	Convergent Reflective	Transparent	
Part Number	SA1E-□T	SA1E-□P	SA1E-D	SA1E-N	SA1E-□B	SA1E-G	SA1E-X	
Power Voltage	12 to 24V DC (Operating range: 10 to 30V DC), Equipped with reverse-polarity protection							
Current Draw	Projector: 15mA Receiver: 20mA Laser Receiver: 30mA	30 mA with laser: 35mA					20mA maximum	
Sensing Range	With sensitivity adjustment: 10m Laser models: 30m	w/ sensitivity adjustment: 2.5m (IAC-R5/R8) 1.5m (IAC-R6) 1.3m (IAC-RS2) 1.0m (IAC-RS1) 0.8m (IAC-R7□) ¹ Laser models 0.3-10m	700mm (using 200 × 200mm white mat paper)	50 to 150mm (using 100 × 100mm white mat paper)	20mm to preset (using 200 × 200mm white mat paper) with laser: 20-300mm	5 to 35mm (using 100 × 100mm white mat paper)	2m (when using IAC-R9)	
	Without sensitivity adjustment: 15m	w/o sensitivity adjustment: 3.0m (IAC-R5/R8) 2.0m (IAC-R6) 1.4m (IAC-RS2) 1.1m (IAC-RS1) 1.0m (IAC-R7□) ¹						
Adjustable Sensing Range	—		—		40 to 200mm with laser: 40-300mm	—	—	
Detectable Object	Opaque		Opaque/Transparent		Opaque	Opaque/ Transparent	Opaque, transparent and mirror-like objects	
Hysteresis	—		20% maximum		10% maximum	20% maximum	—	
Response Time	1ms maximum, with laser: 250us						500μs maximum	
Sensitivity Adjustment	Adjustable using a potentiometer (approx. 260°) Through-beam type and polarized retroreflective type are also available w/o sensitivity adjustment. Laser models: 2 turn adjustment				—	Adjustable using a potentiometer (approx. 260°)	Adjustable using a potentiometer (approx. 240°)	
Sensing Range Adjustment	—				6-turn control knob	—	—	
Light Source Element	Infrared LED, Red LED, Red laser diode	Red LED Red laser diode	Infrared LED	Red LED	Red LED Red laser diode	Infrared LED	Red LED	
Operation Mode	Light ON/Dark ON							
Control Output	NPN open collector or PNP open collector, 30V DC, 100 mA maximum Voltage drop: 1.2V maximum (BGS type: 2V maximum), Short-circuit protection							
LED Indicators	Operation LED: Yellow Stable LED: Green, Power LED: Green (Through-beam type projector)				Operation LED: Yellow Stable LED: None	Operation LED: Yellow Stable LED: Green	Operation LED: Yellow Stable LED: None	
Interference Prevention	—							
Degree of Protection	Two units can be mounted in close proximity. IP67 (IEC 60529)							
Extraneous Light Immunity	Sunlight: 10,000 lux maximum, Incandescent lamp: 5,000 lux maximum (at receiver)							
Operating Temperature	-25 to +55°C (no freezing)							
Operating Humidity	35 to 85% RH (no condensation)							
Storage Temperature	-40 to +70°C (no freezing)							
Insulation Resistance	Between live part and mounting bracket: 20 MΩ maximum (500V DC megger)							
Dielectric Strength	Between live part and mounting bracket: 1000V AC, 50/60Hz, 1 minute							
Vibration Resistance	Damage limits: 10 to 55Hz, Amplitude 0.75mm, 20 cycles in each of 3 axes							
Shock Resistance	Damage limits: 500m/s ² , 10 shocks in each of 3 axes							
Material	Housing: PC/PBT, Lens: PC (Polarized retroreflective / coaxial polarized retro-reflective: PMMA), Indicator cover: PC							
Attachments	Instruction sheet							
Weight (approx.)	Cabel Model	Projector: 30g Laser Projector: 35g Receiver: 30g ² Laser Receiver: 35g	30g ² with laser: 35g		35g ³	30g ²	35g ³	
	Connector Model	Projector: 10g Laser Projector: 20g Receiver: 10g Laser Receiver: 20g	10g with Laser 20g		20g	10g	20g	
Connection Method	Cable Model	ø3.5mm, 3-core, 0.2mm ² , 1-m vinyl cabtyre cable (2-core for the projector of through-beam type)						
	Connector Model	M8 connector (4-pin)						

- Maintain at least the distance shown below between the SA1E photoelectric switch and reflector. IAC-R5/R6/R7□/R8: 100 mm, IAC-RS1/RS2: 150mm
The detection distance cannot be guaranteed if the reflector is deformed or the tape type reflector is applied on uneven surface.
- Cable length: 1m (50g when the cable length is 2m, 55g for laser models. 110g when the cable length is 5m, 120g for laser models.)
- Cable length: 1m (55g when the cable length is 2m. 120g when the cable length is 5m.)
- For laser models insert L in place of □.

Dimensions

Cable Models

Through-beam, Polarized Retro-reflective, Convergent, Diffuse-reflective, Small-beam reflective

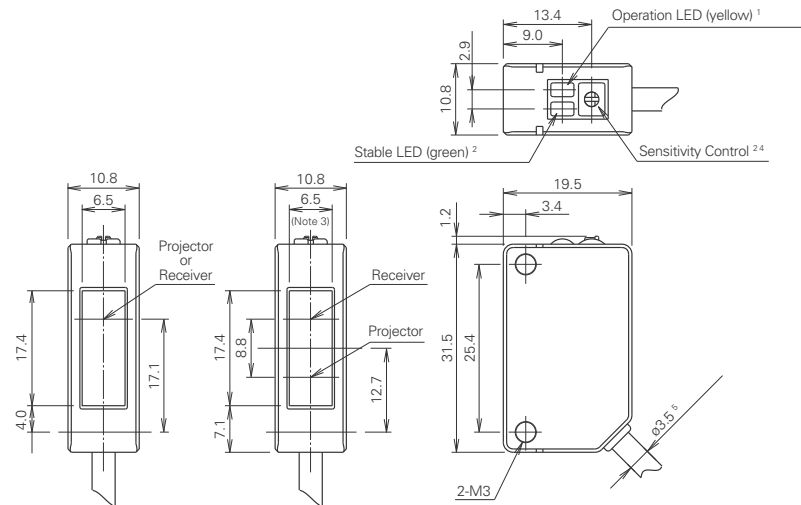

1. Power ON LED (green) for through-beam projector.
2. No sensitivity control and stable LED are attached on the through-beam projector.
3. 5.2 mm for polarized retroreflective model.
4. No sensitivity control is installed on the models without sensitivity adjustment.

Background Suppression (BGS)

Transparent

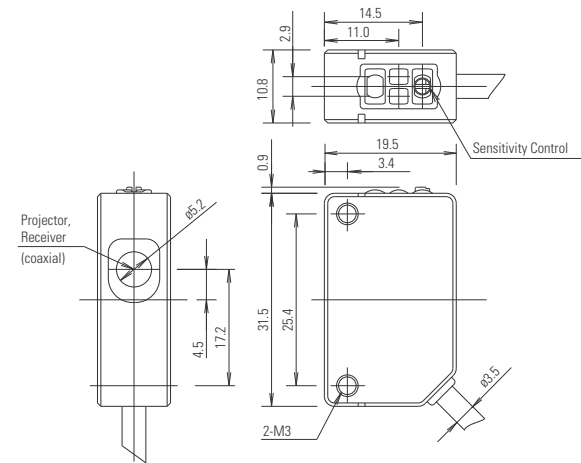
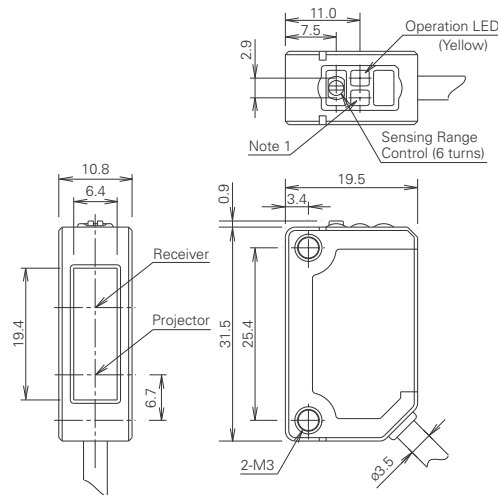

Stable LED is not provided on the background suppression or coaxial polarized retro-reflective models.

Laser (Through-beam, Polarized Retro-reflective, Background Suppression)

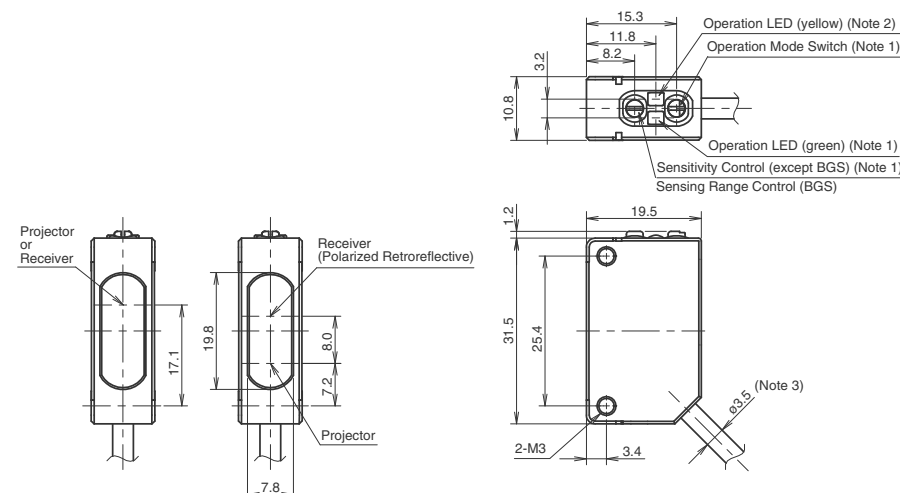

Connector Models

Through-beam, Polarized Retro-reflective, Convergent, Diffuse-reflective, Small-beam reflective

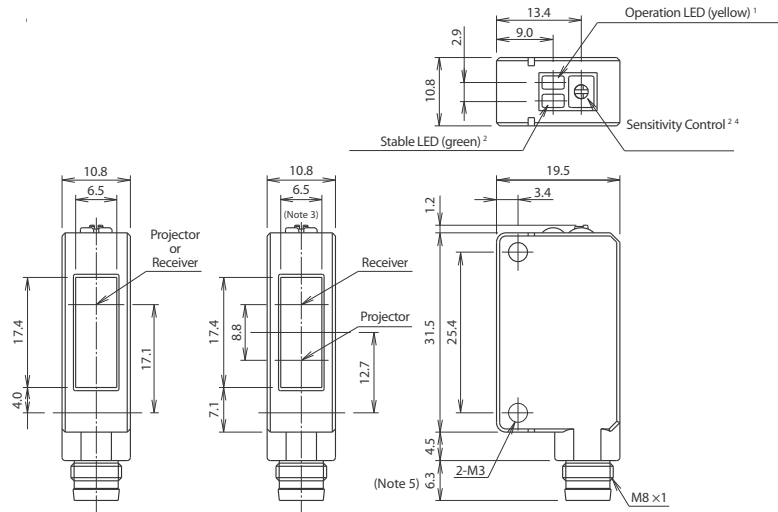

1. Power ON LED (green) for through-beam projector.
2. No sensitivity control and stable LED are attached on the through-beam projector.
3. 5.2 mm for polarized retroreflective model.
4. No sensitivity control is installed on the models without sensitivity adjustment.

Background Suppression (BGS)

Transparent

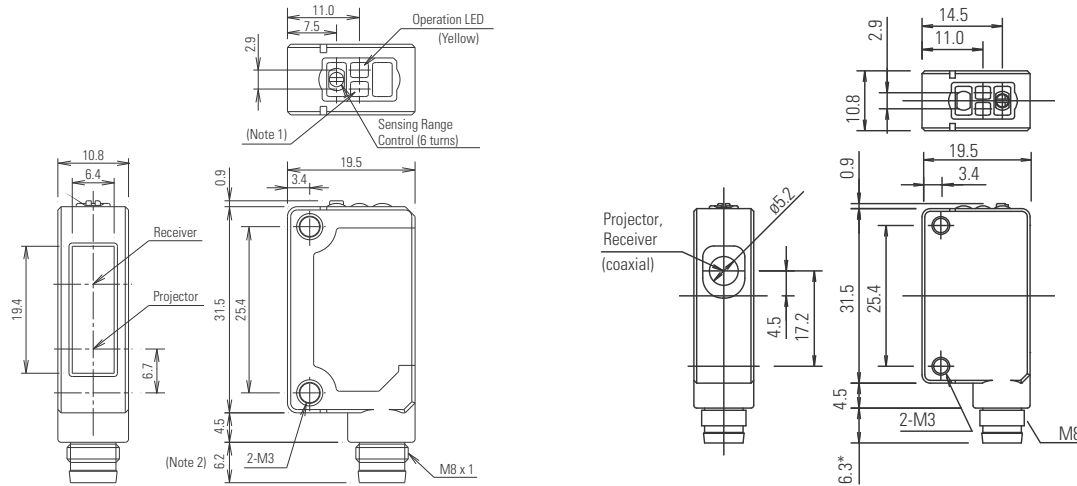

1. Stable LED is not provided on the background suppression or coaxial polarized retro-reflective models.
2. The connector length is 18mm when a right-angle connector cable is used.

Laser (Through-beam, Polarized Retro-reflective, Background Suppression)

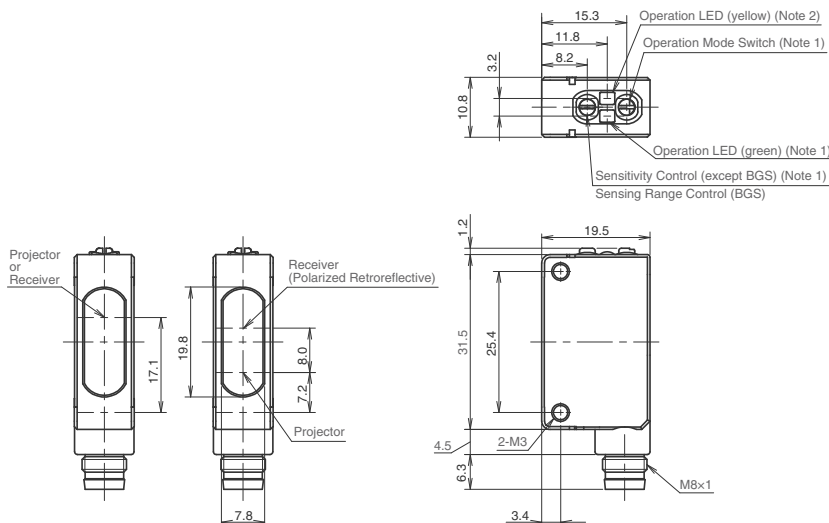



The best PLCs for your money

IEC controllers offer speed, power, performance and precision, as well as being easy to use, and easy to maintain. Just a simple, ready-made solution that won't require time you don't have to give. Instead, save time with a reliable product that gives you faster response, better throughput, and less downtime. For more information, visit www.IDEC.com/plc.

PLC Training

Want more MicroSmart and WindLDR experience? Get hands-on guidance from IEC's expert technical staff. These intensive, three-day sessions cover PLC and touchscreen programming, setup, troubleshooting and more. Classes are held throughout the year at various locations in the US and Canada. For the latest schedule of upcoming classes, visit our web site at training.IDEC.com.

Find your local IEC Representative or Distributor

Visit www.IDEC.com/usa/locator or call 800-262-IEC.



Get the power you need

IEC power supplies offer worldwide approvals, universal voltage inputs, fused inputs, auto-resetting overload protection and various styles. In fact, the new PS5R Slim Line models give you all the power of a traditional power supply in only half the space. Utilize them in tight places or save valuable DIN Rail space while still filling your requirements for power. For more information, visit www.IDEC.com/powersupply.



Product Support

Technical support:

support@idec.com

Sales support:

sales@idec.com



Think Automation and beyond...

800.262.4332

www.IDEC.com/sensor

www.IDEC.com

USA
IEC Corporation
Tel: (408) 747-0550
opencontact@idec.com

Canada
IEC Canada Ltd.
Tel: (905) 890-8561
sales@ca.idec.com

Australia
IEC Australia Pty. Ltd.
Tel: +61-3-8523-5900
sales@au.idec.com

Japan
IEC Corporation
Tel: +81-6-6398-2571
products@idec.co.jp

United Kingdom
IEC Electronics Ltd.
Tel: +44-1256-321000
sales@uk.idec.com

Germany
IEC Elektrotechnik GmbH
Tel: +49-40-253054-0
service@idec.de

Hong Kong
IEC (H.K.) Co., Ltd.
Tel: +852-2803-8989
info@hk.idec.com

China/Beijing
IEC (Beijing) Corporation
Tel: +86-10-6581-6131
idec@cn.idec.com

China/Shanghai
IEC (Shanghai) Corporation
Tel: +86-21-6135-1515
idec@cn.idec.com

China/Shenzhen
IEC (Shenzhen) Corporation
Tel: +86-755-8356-2977

Singapore
IEC Asia Pte. Ltd.
Tel: +65-6746-1155
info@sg.idec.com

Taiwan
IEC Taiwan Corporation
Tel: +886-2-2698-3929
service@tw.idec.com

©2012 IEC Corporation. All Rights Reserved.
Catalog No. SA9Y-B100-0 06/12 PDF only

Specifications and other descriptions in this catalog are subject to change without notice.