

OUTLINE DIMENSIONS

KA SERIES

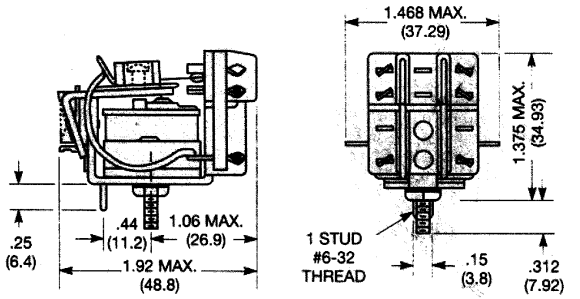

KR3-H

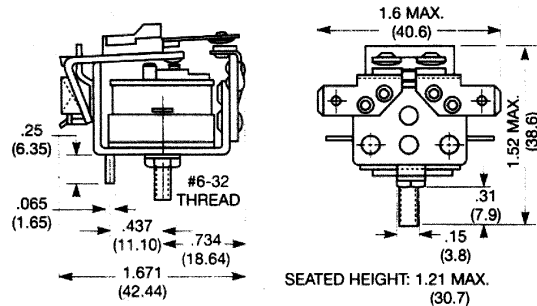

TOLERANCES ON .XX DECIMALS ± .02 (± .5) UNLESS OTHERWISE SPECIFIED
TOLERANCES ON .XXX DECIMALS ± .005 (± .13) UNLESS OTHERWISE SPECIFIED

KR SERIES ENCLOSURES

TYPE "P" CLEAR DUST COVER

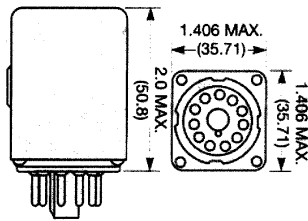

For KRPA and KRP

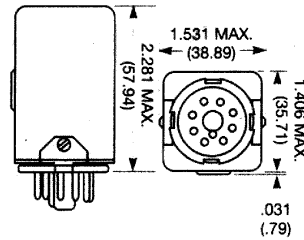

For KRP3-H

OPTIONAL HERMETICALLY SEALED ENCLOSURE



Height: 2.125" (53.98 mm) max.

Octal Plug

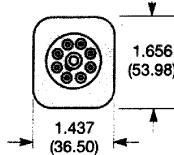

HOLD-DOWN SPRING

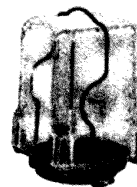

20C176 KRPA & KRP
20C206 KAP and KRP3

Durable stainless steel spring can be moved aside for relay removal or installation. Mounts with same machine screws or rivets that secure socket to chassis. Two .156" (3.96 mm) dia. holes required.

WIRING DIAGRAMS (Bottom Views)

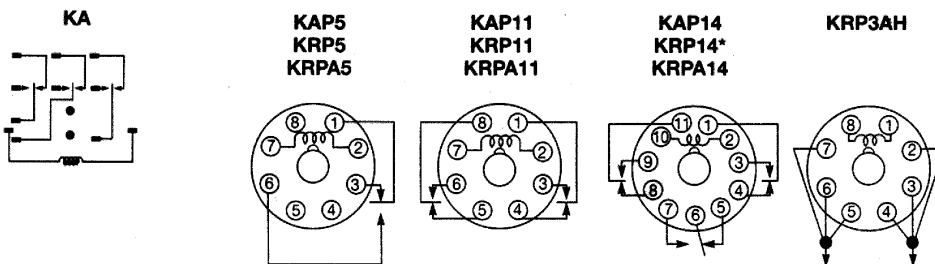

*The hermetically sealed KRP14 has pins 5 and 6 reversed.