

700 Series Dimensions: mm (inches) cont.

R Case (7mm Display Only):

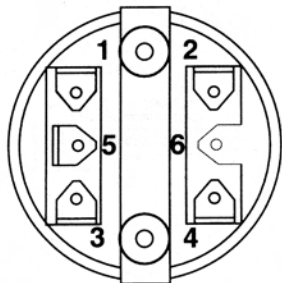

Terminals for 7mm R & S cases:

- 1: V+
- 2: V-
- 3: Reset + (optional)
- 4: Signal Input (+ enable for elapsed time function on 701, + enable for pulse input on 703)
- 5: Backlighting - **12VDC Only**
- 6: No connection

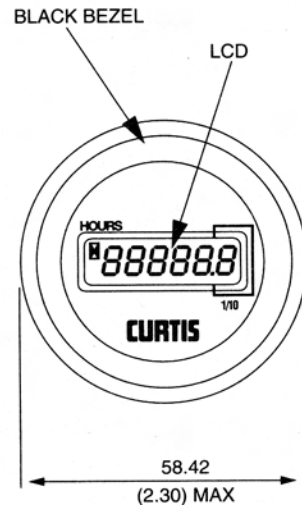
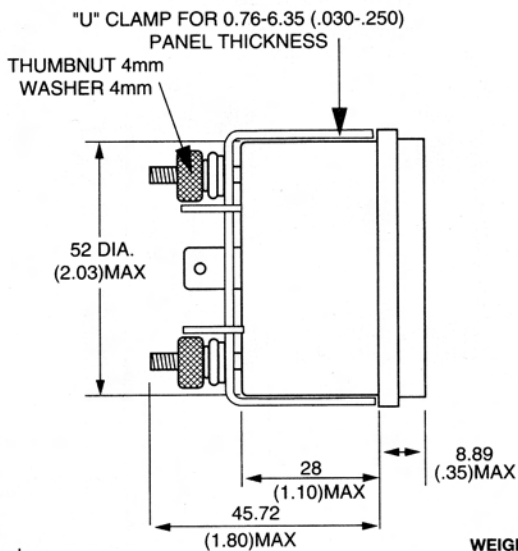

WEIGHT: 75 Grams max
LENS MATERIAL: Glass
CASE MATERIAL: Lexan 940, Black
BEZEL MATERIAL: Aluminum, Black Anodized
RECOMMENDED PANEL CUTOUT: 52mm (2 1/16") dia.

S Case (7mm Display Only):

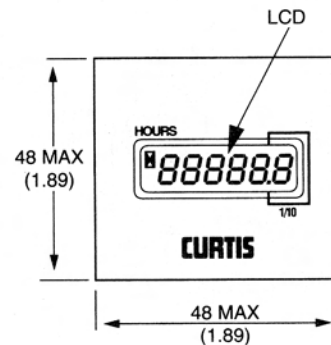
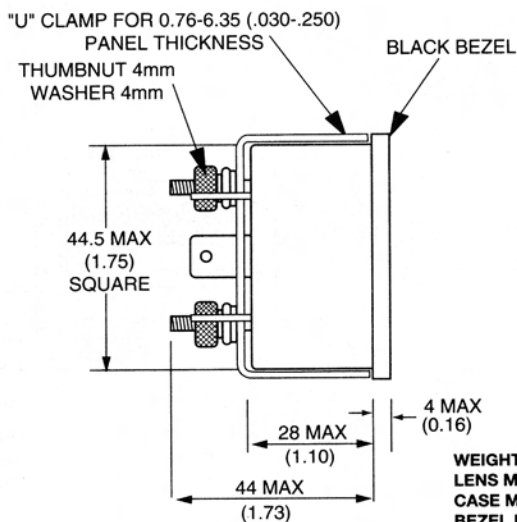
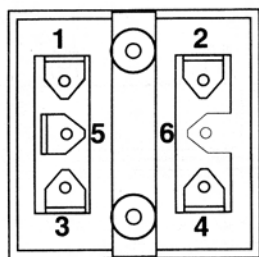

WEIGHT: 75 Grams max
LENS MATERIAL: Glass
CASE MATERIAL: Cycolac ABS, Black
BEZEL MATERIAL: Cycolac ABS, Black
RECOMMENDED PANEL CUTOUT: 45x45mm DIN

E Case (701, 703DC only):

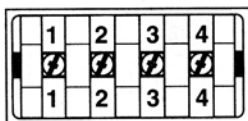

Terminals for E case:

- 1: V+
- 2: Reset + (optional)
- 3: Signal Input (+ enable for elapsed time function on 701, + enable for pulse input on 703)
- 4: V-

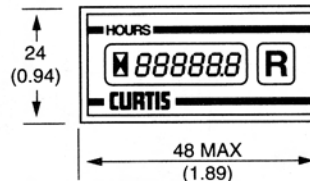
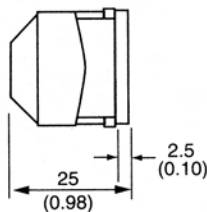

WEIGHT: 33 Grams max
CASE MATERIAL: Poly-Amide (Nylon)
RECOMMENDED PANEL CUTOUT: 45x22.2mm DIN (DIN 43700)
PANEL THICKNESS: 0.8mm - 7.0mm