

# Latching, Sequence and Impulse Relays – Application Data

## Energy Conservation Relays

In many applications it is important for the customer to conserve electrical energy. One approach to energy conservation in an electrical system is to use relays that do not require constant power to maintain contact closure.

“Latching relay” is a generic term that is used to describe a relay that maintains its contact position after the control power has been removed. Latching relays allow a customer to control a circuit by simply providing a single pulse to the relay control circuit. Latching relays are also desirable when the customer needs to have a relay that maintains its position during an interruption of power.

There are three main types of Latching relays. Magnetic latching, Mechanical Latching and Impulse Sequencing.

## Magnetic Latching Relays

Magnetic Latching relays require one pulse of coil power to move their contacts in one direction, and another, redirected pulse to move them back. Repeated pulses from the same input have no effect. Magnetic Latching relays are useful in applications where interrupted power should not be able to transition the contacts.

Magnetic Latching relays can have either single or dual coils. On a single coil device, the relay will operate in one direction when power is applied with one polarity, and will reset when the polarity is reversed. On a dual coil device, when polarized voltage is applied to the reset coil the contacts will transition. AC controlled magnetic latch relays have single coils that employ steering diodes to differentiate between operate and reset commands.



## Mechanical Latching Relays

Mechanical latching relays use a locking mechanism to hold their contacts in their last set position until commanded to change state, usually by means of energizing a second coil. Since the relay does not rely on a magnet, the locking strength will not degrade over time or weaken during thermal cycling. The contacts will remain locked in the directed position until the opposing coil has been energized. Packaging machinery that places several units into a single container would be a good example.



## Impulse Relays

Impulse relays are a form of latching relay that transfers the contacts with each pulse. Many impulse relays are made up of a magnetic latch relay and a solid state steering circuit that, upon application of power, determines which position the relay is in and energizes the opposite coil. The contacts transfer and hold that position when power is removed. When reenergized, the contacts transfer again and hold that position, and so on. In order to transfer the contacts, one simply provides a single unidirectional pulse. There is no need to redirect the control pulse or reverse the polarity.

Impulse relays can be used as wear equalizers. They are well suited for applications such as turning a single device on or off from one or more locations with a single momentary switch or push button at each station. For example, a conveyor could be started and/or stopped from multiple locations by means of a single button at each position.





## 712 Alternating Relay

In many industrial pumping applications, two identical pumps are used for the same job. A standby unit is available in case the first pump fails. However, a completely idle pump might deteriorate and provide no safety margin. Alternating relays prevent this by assuring that both pumps get equal run time.









The Model 712 Series Alternating Relay is designed for duplex pumping systems where it is desirable to equalize pump run time. The solid state alternating circuit drives an internal electromechanical relay. A continuous power source and control switch is required.

The control switch (float, pressure or other isolated contact) is connected as shown in the respective wiring diagrams. Each time the control switch is opened the output contacts will change status. Indicator lights on the case show the internal relay status.

Setting the top toggle switch to the “center position” alternates the load; while setting the switch to “Load 1” or “Load 2” will lock the relay in the respected position, preventing alternation.

The alternating relay approach isn’t limited to pumping applications. The control switches could be thermostats or pressure switches, and the loads could be fans or compressors.

### Applications:

<b>INDUSTRIAL AUTOMATION</b>	<b>INDUSTRIAL APPLIANCES</b>	<b>PACKING MACHINES</b>	<b>PUMPING MACHINES</b>	<b>COMPRESSORS</b>	<b>INDUSTRIAL FANS</b>
					

# 755 Magnetic Latching Octal Relay/DPDT, 16 Amp Rating



High strength magnetic latch helps contacts hold during vibration.



Single and Dual (DC only) coil available.

16 Amp switching capabilities

Standard 11 pin octal socket mounting.

## General Specifications (UL 508)

Contact Characteristics		Units	755XB
Number and type of Contacts			DPDT
Contact materials			Silver Alloy
Thermal (Carrying) Current		A	16
Maximum Switching Voltage		V	300
Switching Current @ Voltage	~	Resistive	16A @ 277V 50/60Hz
	⎓	Resistive	16A @ 28V
	⎓	HP	1/3 @ 120 VAC
	⎓	HP	1/2 @ 240 VAC
	⎓	Pilot Duty	B300
Minimum Switching Requirement		mA	100 @ 5 VDC (.5W)
Coil Characteristics			
Voltage Range	~	V	12...240, 50/60 Hz
	⎓	V	12...125
Operating Range	~	% of Nominal	85% to 110%
	⎓		80% to 110%
Average consumption	~	VA	2
	⎓	W	1.64
Drop-out voltage threshold	~		15%
	⎓		10%
Performance Characteristics			
Electrical Life (UL508)	Operations @ Rated Current	(Resistive)	100,000
Mechanical Life	Unpowered		10,000,000
Operating time (response time)		ms	30
Dielectric strength	Between coil and contact	~	V(rms) 2500
	Between poles	~	V(rms) 1500
	Between contacts	~	V(rms) 2500
Environment			
Product certifications	Standard version		UL
Ambient air temperature around the device	Storage	°C	-40...+85
	Operation	°C	-40...+55
Vibration resistance	Operational	g-n	3, 10 - 55 Hz
Shock resistance		g-n	10
Degree of protection			IP 40
Weight		grams	170

### OCTAL BASE LATCHING RELAY

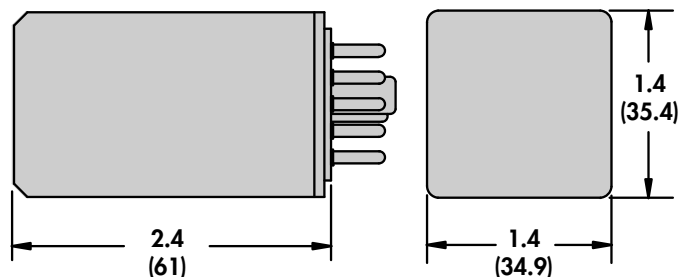
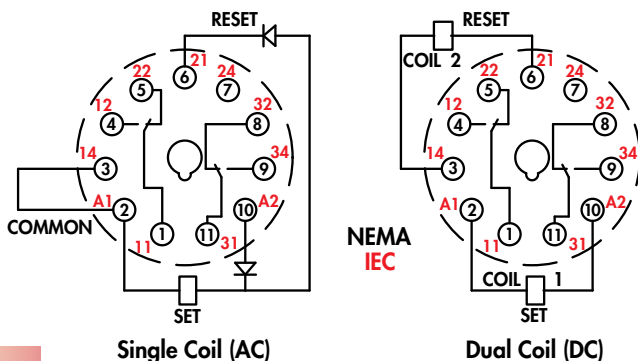

SECTION 7



The 755 Magnetic Latching relay, with an 11 pin octal base, operates by using a pulsed input. A permanent magnet maintains the last position until a redirected second pulse moves the contacts back to the original state.

**755 Relay with the 70-750EL11-1 Socket**

**Standard Part Numbers**

**BOLD-FACED PART NUMBERS ARE NORMALLY STOCKED**

Nominal Voltage	Coil Resistance	Part Number
AC Operated (Single Coil)		
6 VAC 50/60 HZ	32 Ohms	755XBXC-6A
12 VAC 50/60 HZ	120 Ohms	755XBXC-12A
24 VAC 50/60 HZ	470 Ohms	<b>755XBXC-24A</b>
120 VAC 50/60 HZ	10,000 Ohms	<b>755XBXC-120A</b>
240 VAC 50/60 HZ	36,000 Ohms	755XBXC-240A
DC Operated (Dual Coil)		
6 VDC	22/22 Ohms	755XBXCD-6D
12 VDC	90/90 Ohms	<b>755XBXCD-12D</b>
24 VDC	350/350 Ohms	<b>755XBXCD-24D</b>
48 VDC	1,400/1,400 Ohms	755XBXCD-48D
110/125 VDC	9,000/9,000 Ohms	<b>755XBXCD-125D</b>

**Part Number Builder**

755	XBX	C	-	240A
Series	Contact Configuration	Coil Options		Coil Voltage
755	DPDT = XBX	Single Coil = C Double Coil = CD		VAC = 6 - 240A VDC = 6 - 125D

**Other mating sockets see Section 2: 70-750E11-1, 70-750DL11-1, 70-464-1, 70-170-5**

