

Specification

Revised 2021/12/15

Liquialloy™ Power Inductor GLULK Series

Features

- 2.5mm × 2.0mm square and 1.0mm max height
- Under surface terminal
- Liquialloy™ ; Super low core loss material for high switching frequency DC/DC converter
- Excellent low heat generating characteristics due to low DCR
- Metal composite structure (compact and high current capability)
- RoHS compliant.
- Halogen Free.

Application

- For use in DC/DC converter in portable device
(Smartphone , Tablet PC , SSD , HDD , DSC , Game etc.)

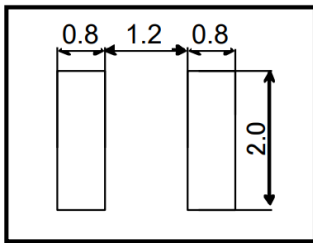

Recommended pattern

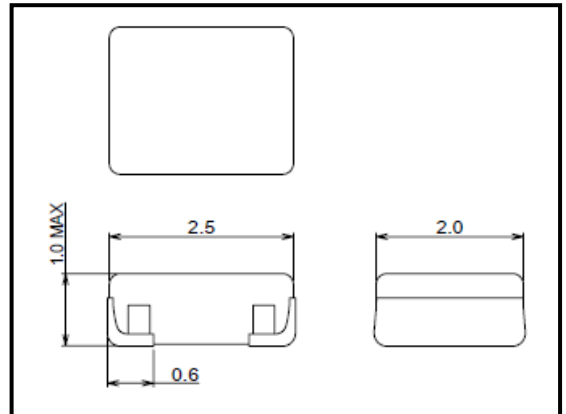
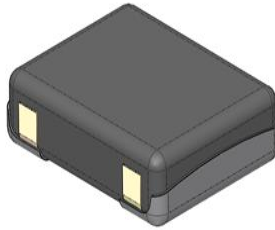

Unit: mm

- Operating Temperature : -40 to +125 [°C]
(Including self temperature rise)
- Withstand DC Voltage : 20[V]
- Operating Voltage : 16[V]

| Part No. | Inductance ±20% (μH) | DC Resistance (mΩ) Max. (Typ.) | AC Resistance (mΩ) Typ. | Saturation Current Idc1(A) Max.(Typ.) | Heat Rating Current Idc2(A) Max. (Typ.) |
|-------------|----------------------------|--------------------------------------|-------------------------------|--|--|
| GLULKR4701A | 0.47 | 24 (20) | 22 | 3.6(4.5) | 3.9(4.9) |
| GLULK1R001A | 1.0 | 48 (40) | 58 | 2.4(3.1) | 2.6(3.3) |
| GLULK1R501A | 1.5 | 70 (58) | 79 | 2.1(2.7) | 2.2(2.8) |
| GLULK2R201A | 2.2 | 102 (85) | 111 | 1.8(2.3) | 1.7(2.2) |
| GLULK4R701A | 4.7 | 192 (160) | 196 | 1.2(1.6) | 1.3(1.7) |

- Idc1: DC Current that will make inductance decreased to $\Delta L/L$ of 30%
- Idc2: DC Current that will make inductor temperature increased to 40°C in ΔT
- Test condition : Temperature $20 \pm 2^\circ\text{C}$ / Relative humidity $65 \pm 5\% \text{RH}$
- Test condition(Inductance, AC Resistance) : 1MHz, 10mArms

Typical Inductance & Q vs. Frequency

Revised 2021/12/15

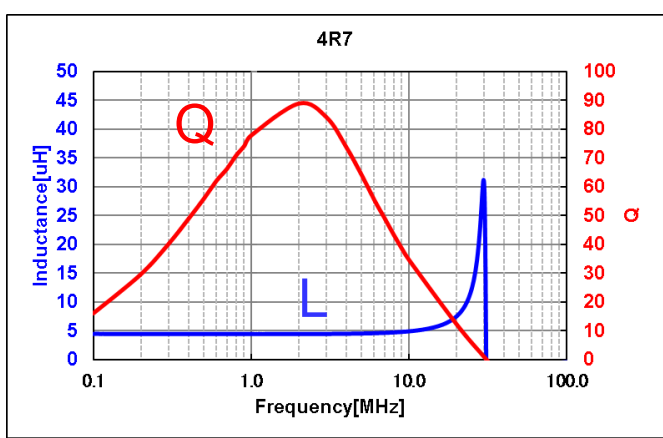
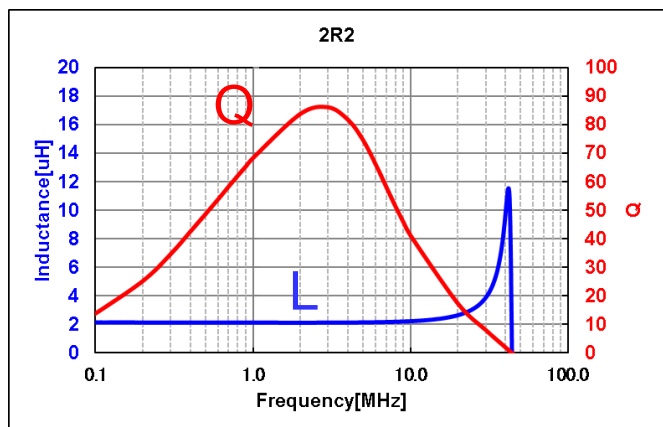
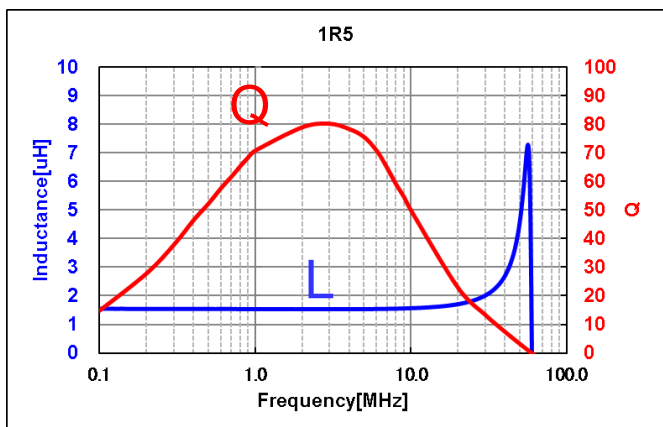
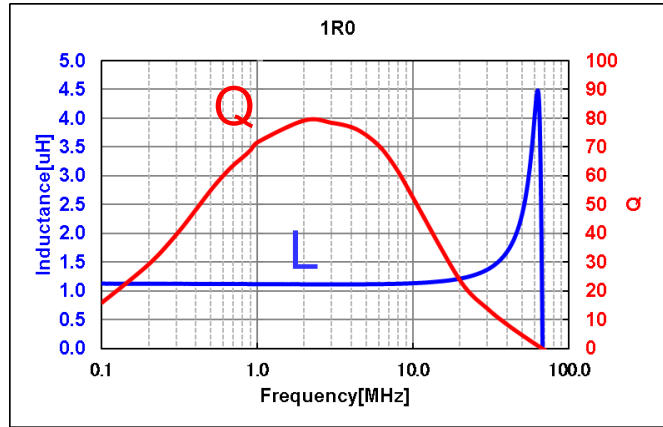
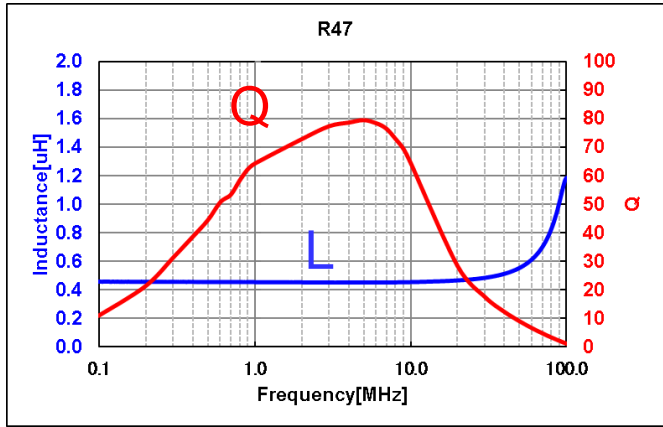

Typical Inductance & Δ Temperature vs. Load Current

Revised 2021/12/15

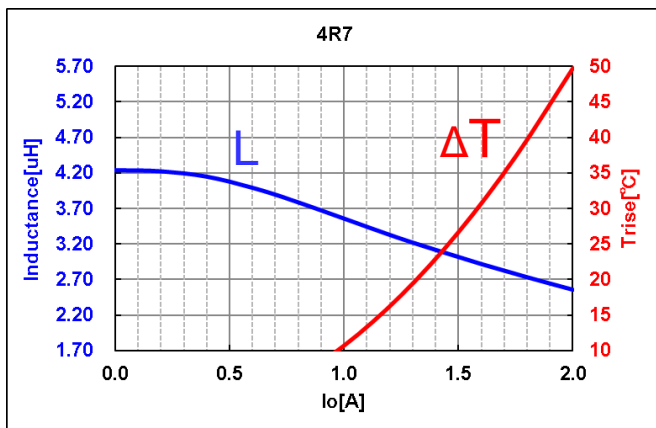
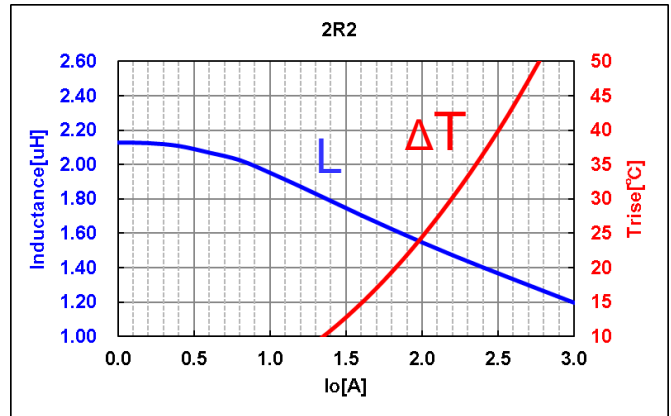
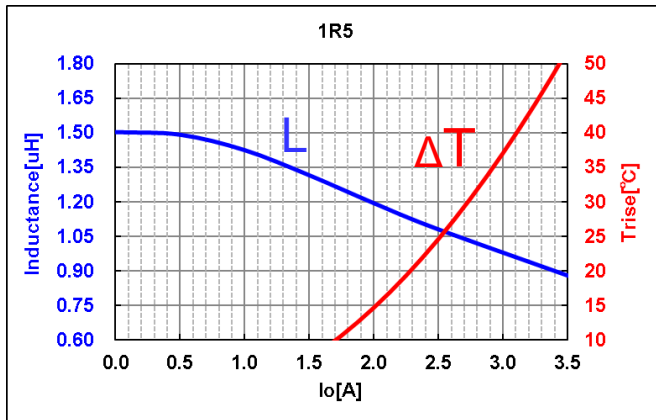
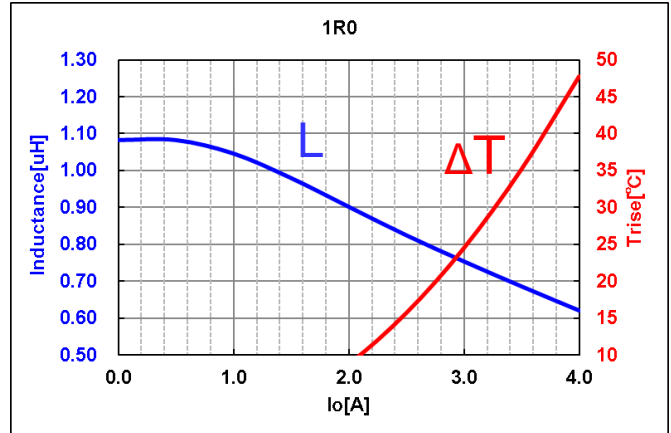
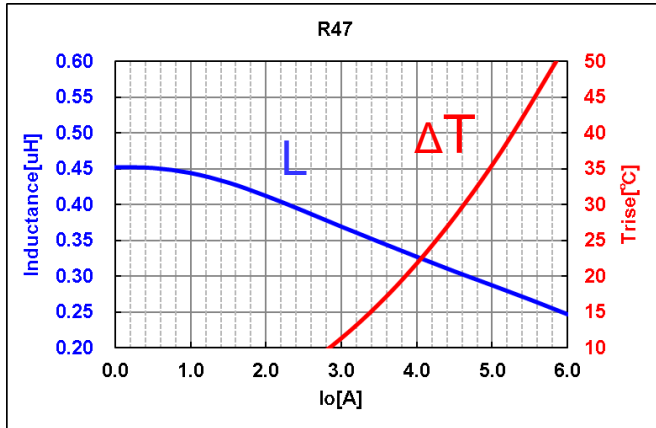

Typical ACR vs. Frequency

Revised 2021/12/15

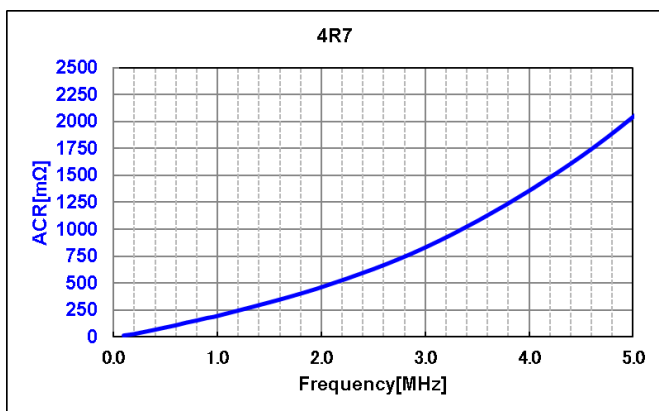
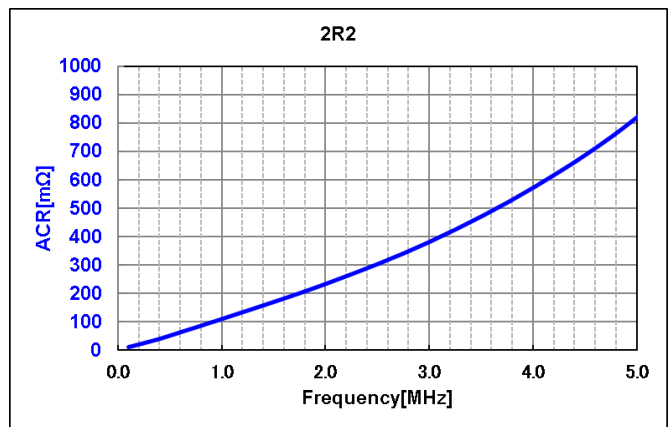
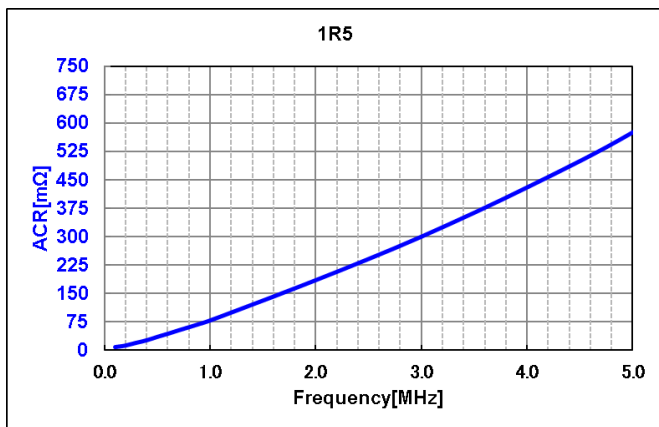
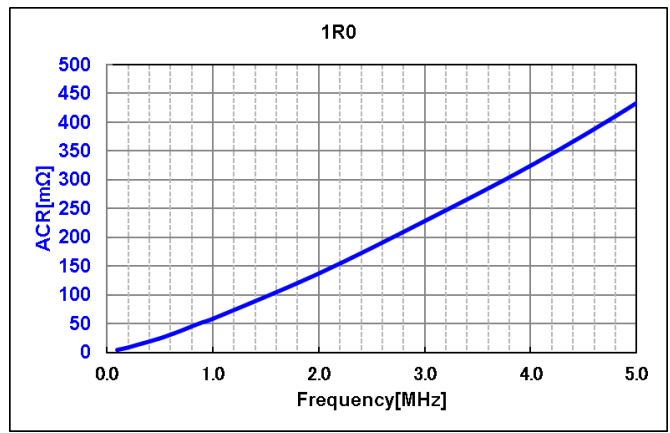
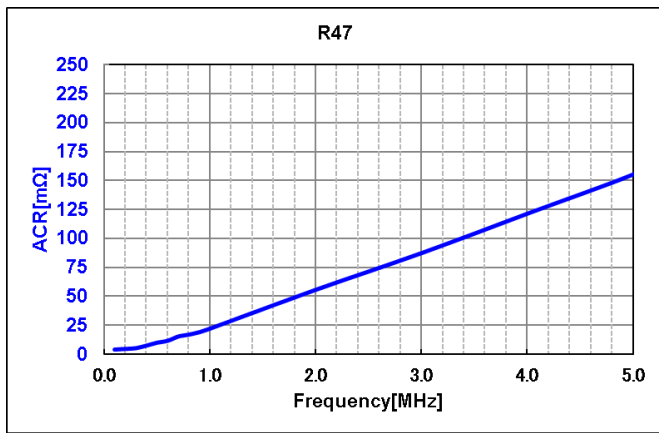

Revised 2021/12/15

Precautions when handling our products

1. For the export of products which are controlled items subject to foreign and domestic export laws and regulations, you must obtain approval and/or follow the formalities of such laws and regulations.
2. Products must not be used for military and/or antisocial purposes such as terrorism, and shall not be supplied to any party intending to use the products for such purposes.
3. Unless provided for otherwise, the products have been designed and manufactured for application in equipment and devices which are sold to end users in the market, including audio-visual (AV) equipment, electrical home appliances, office machines, information and communication equipment, and amusement equipment. The products are not intended for use in, and must not be used for, any application for nuclear equipment, driving equipment for aerospace or any other unauthorized use. With the exception of the abovementioned prohibited applications, please contact an Alps sales representative and/or evaluate the total system regarding applicability for applications involving high levels of safety and liability such as medical equipment, burglar alarm equipment, disaster prevention equipment and undersea equipment. Please also incorporate fail-safe design, protection and redundant circuitry, malfunction protection, and/or fire protection into the complete system to ensure safety and reliability of the total system.
4. Before using products which were not specifically designed for use in automotive applications, please contact an Alps sales representative.

Cautions for using this catalog

1. The specifications herein are an overview of the specifications. Obtain official specifications before use.
2. The colors of the products this technical data sheet may slightly differ from those of the actual products.
3. The external appearance, functions and other specifications herein may be discontinued without prior notice.

Inquiries about this product

Products Information Center
+81 (3) 5499-8154
Products Information Site
[Http://www.alps.com/products/e/](http://www.alps.com/products/e/)

ALPSALPINE CO., LTD.

1-7, Yukigaya-otsukamachi, Ota-ku, Tokyo, Japan 145-8501

