

## Motor-driven Master Type (Motor N Fader, Motor K Fader, Motor V Fader)

Provides a superior operational feel with high-speed tracking in motor drive mode

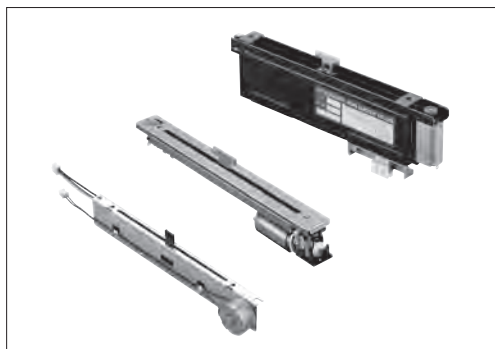

### Typical Specifications

Items	Specifications		
	Motor N fader	Motor K fader	Motor V fader
Total resistance tolerance	±20%		
Maximum operating voltage	10V DC, 200V AC (Travel: 60mm) 10V DC, 500V AC (Travel: 100mm)		
Operating force	0.8±0.5N	0.4±0.25N	—
Operating life	30,000 cycles	300,000 cycles	100,000 cycles
Rated voltage of motor	10V DC		8V DC
Maximum current of motor	800mA or less (at 10V DC)		625mA or less (at 5V DC)
Operating temperature range	-10°C to +60°C		

### Product Line

Number of resistor elements	Travel (mm)	Type	Lever type	Length of lever (mm)	Total resistance (kΩ)	Resistance taper	Terminal style	Touch sense track	Minimum order unit (pcs.)		Products No.	Drawing No.
									Japan	Export		
Single-unit	60	Motor N Fader	9-T (T-bar)	8.2	10	1B	Lead	With	120	120	<b>RS60N11M9A0E</b>	1
							For PC board (for auto dipping)			240	<b>RS60N11M9A0F</b>	2
	100	Motor K Fader (CP type)	—	10.95	Lead	Without	80	80	<b>RSA0N11M9A0K</b>	3		
					For PC board (for auto dipping)			160	<b>RSA0N11M9A0J</b>	4		
		Motor V Fader	—	10.95	Connector	42	84	<b>RSA0K11V901S</b>	5			
						80	80	<b>RSA0V11M9001</b>	6			

#### Note

Other varieties are also available. Refer to "Other Specifications" (P.380).

### Packing Specifications

Bulk/Tray

Product No.	Terminal style	Packing specifications	Number of packages (pcs.)		Export package measurements (mm)
			1 case /Japan	1 case /export packing	
<b>RS60N</b>	Lead	Tray	120	120	366×280×154
	For PC board			240	375×285×393
<b>RSA0N</b>	Lead		80	80	366×280×154
	For PC board			160	375×285×393
<b>RSA0K</b>	Connector	Bulk	42	84	524×374×201
<b>RSA0V</b>		Tray	80	80	540×360×205

Refer to P.380 for other specifications.  
 Refer to P.380 for details of lever types.  
 Refer to P.381, 382 for ordering products not listed.  
 Refer to P.383 for soldering conditions.

Dimensions

Unit:mm

No.	Style
1	<p>Technical drawing of Style 1 potentiometer. Dimensions include: 54, 80, 52.5, 2-M3, 17, 60(Travel), 18.5, 8.2, 0.4, (7.35), (43.6), (41), (10), (13.8), 21 max., 1.5, 18.5, (14.5), (8), (2), 4, 8.2, 1.5, 1.2, 2-(ø2). Terminal No. 1, 2, 3, T, A, B are indicated.</p>
2	<p>Technical drawing of Style 2 potentiometer. Dimensions include: 54, 80, 52.5, 2-M3, 18 max., 18.5, 8.2, 0.5, 60(Travel), 18.5, 26, 0.4, 1.5, 18.5, (14.5), (8), (2), 4, 8.2, 1.5, 1.2, 2-(ø2). Terminal No. 1, 2, 3, T, A, B are indicated.</p> <p>PC board mounting hole dimensions (Viewed from mounting side):</p> <p>L:Lug terminal</p>
3	<p>Technical drawing of Style 3 potentiometer. Dimensions include: 74, 120, 72.5, 2-M3, 17, 100(Travel), 18.5, 8.2, 0.4, 27.35, (63.6), (61), (10), (13.8), 21 max., 1.5, 18.5, (14.5), (8), (2), 4, 8.2, 1.5, 1.2, 2-(ø2). Terminal No. 1, 2, 3, T, A, B are indicated.</p>

Rotary Potentiometers

Slide Potentiometers

General-use

Mixer

Dimensions

Unit:mm

No.	Style	PC board mounting hole dimensions (Viewed from mounting side)
4		<p>L:Lug terminal</p>
5		
6		

Rotary  
Potentiometers

Slide  
Potentiometers

General-use

Mixer

# Motor-driven Master Type / Other Specifications

In addition to the Product Line, we accommodate the following specifications. Combinations not included in the Product Line are treated as semi-standard products.

## Products Specifications

Type		Travel (mm)	Model	Operating force	Touch sense track	Terminal
Single-unit	Motor N fader	60	RS60N11M	0.8±0.5N	Available	For PC board (for auto dipping) Lead
			RSA0N11M			
	Motor K fader CP type	100	RSA0K11V	0.4±0.25N		Fader terminal: Connector Motor terminal: Lead
Dual-unit (Servo + Audio track)	Motor N fader	60	RS60N12M	0.8±0.5N		Lead
			RSA0N12M			
	Motor K fader CP type	100	RSA0K12V	0.5 $\begin{smallmatrix} +0.4 \\ -0.25 \end{smallmatrix}$ N		Fader terminal: Connector Motor terminal: Lead

## Lever Types

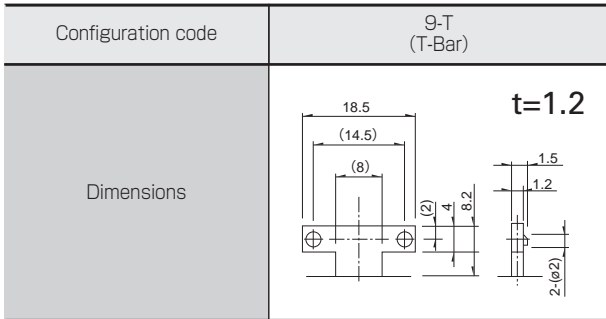

## Total Resistance Variety

Total resistance (k Ω)	10※	50	100	250
------------------------	-----	----	-----	-----

※ Motor K fader, Motor V fader: Only 10kΩ

## Resistance Taper

Resistance taper	Servo	1B		
	Audio	15A	1B	10A

## Circuit Diagram

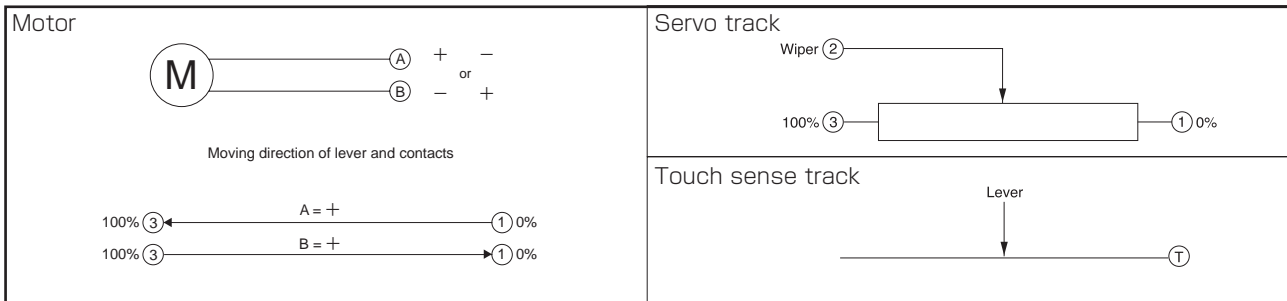

### Note

Marked are specifications recommended by Alps Alpine.

Refer to P.381, 382 for ordering products not listed.

# Motor-driven Master Type (Motor N Fader) / Ordering Products Not Listed

In addition to the Product Line, we accommodate the following specifications. Combinations not included in the Product Line are treated as semi-standard products. Please refer to the notation example below.

## Sample Part Number

**R S 6 0 N 1 1 M - T 0 - B 1 0 3 - P**

Travel

Code	Travel (mm)
60	60
A0	100

Number of resistor elements

Code	Number of resistor elements
1	Single-unit
2	Dual-unit

Touch sense track

Code	Touch sense track
T0	Without
T1	With

Resistance taper

Code	Resistance taper
B	1B
A	15A
D	10A

For dual-units specify the taper of the audio track. Servo track will always be 1B taper.

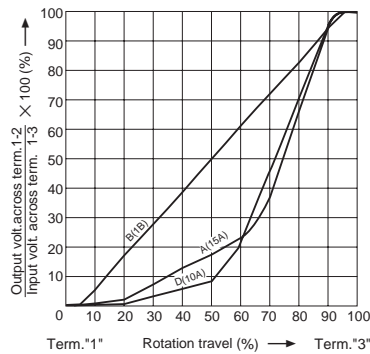

Total resistance

Code	Total resistance (k Ω)
103	10
503	50
104	100
254	250

Terminal configuration

Code	Terminal configuration
P	For PC board
L	Lead

## Note

Marked are specifications recommended by Alps Alpine.

# Motor-driven Master Type (Motor K Fader) / Ordering Products Not Listed

In addition to the Product Line, we accommodate the following specifications. Combinations not included in the Product Line are treated as semi-standard products. Please refer to the notation example below.

## Sample Part Number

**R S A 0 K 1 1 V - T 0 - B 1 0 3**

Number of resistor elements

Code	Number of resistor elements
1	Single-unit
2	Dual-unit

Type

Code	Type
V	CP type

Touch sense track

Code	Touch sense track
T0	Without
T1	With

Resistance taper

Code	Resistance taper
B	1B
A	15A
D	10A

Appoint the taper of audio track in the case of dual-unit. Servo track is surely 1B taper.

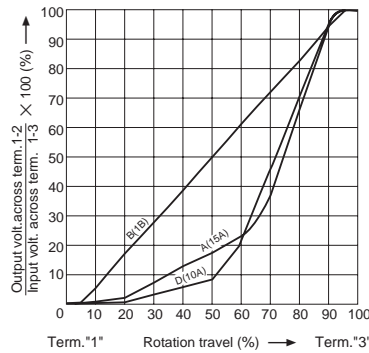

Total resistance

Code	Total resistance (k Ω)
103	10

### Note

Marked are specifications recommended by Alps Alpine.

Rotary Potentiometers











Slide Potentiometers

General-use

Mixer

# Slide Potentiometers

## List of Varieties

Type		Low-profile Master Type		Motor-driven Master Type		
Series		N Fader	P Fader	Motor N Fader	Motor K Fader	Motor V Fader
		RS □□ N	RS6011 □ P	RS □□ N1 □ M	RSA0K1 □ V	RSA0V11M
		Single-unit/Dual-unit	Single-unit/Dual-unit	Single-unit/Dual-unit	Single-unit/Dual-unit	Single-unit
Photo						
Travel (mm)		60, 100	60	60, 100	100	
Direction of lever		Vertical				
Lever material		Metal				Resin
Operating temperature range		-10°C to +60°C				
Operating life		30,000 cycles			300,000 cycles	100,000 cycles
Available for automotive use		—	—	—	—	—
Life cycle						
Electrical performance	Total resistance (k Ω)	10, 50, 100, 250	10, 20, 50	10, 50, 100, 250	10	
	Resistance taper	15A, 1B, 10A		Single-unit: 1B Dual-unit: Servo 1B Audio 15A, 1B, 10A		1B
	Rated Power	0.1W (RS60N) 0.25W (RSA0N)	0.2W (Single-unit) 0.1W (Dual-unit)	0.2W (RS60N1□M) 0.5W (RSA0N1□M)	0.5W	
	Insulation resistance	100MΩ min. 250V DC				
	Voltage proof	250V AC for 1 minute				
	Center-taps	Without				
Mechanical performance	Operating force	Single-unit: $0.3^{+0.5}_{-0.25}$ N Dual-unit: $0.4^{+0.5}_{-0.35}$ N	$0.5^{+1.0}_{-0.4}$ N	0.8±0.5N	Single-unit: 0.4±0.25N Dual-unit: 0.25 to 0.9N	—
	Center detent	Without				
	Stopper strength	100N				10N
	Lever push-pull strength	50N				20N
	Lever wobble (mm) ※ Both sides	$\frac{2(2 \times L)}{25}$				
	Lever deviation (mm)	0.5 max. (One side)				
Terminal style		Insertion		Lead, Insertion	Connector (Fader) Lead (Motor)	Connector
Page		370	374	377		

Slide Potentiometers Soldering Conditions	383
Potentiometer Cautions	384
Potentiometers Measurement and Test Methods	386
Potentiometers Resistance Taper	388

### Notes

- Attenuation is specified for residual resistance.
- "L" in the "Lever Wobble" column of the above table indicates the length of lever.

## Reference for Manual Soldering

Series	Tip temperature	Duration of Soldering time	No. of solders
RS□□1, RS□□H, RS08U, RS□□K (Standard), RS□□N, RS6011□P, RS□□N1□M, RSA0K1□V (Motor terminal)	350°C max.	3s max.	1 time

## Reference for Dip Soldering

Series	Preheating		Dip soldering		Number of soldering
	Soldering surface temperature	Heating time	Soldering temperature	Soldering time	
RS□□1, RS□□H, RS□□N, RS6011□P, RS□□N1□M	100°C max.	1 min. max.	260°C	5s max.	1 time

## Example of Reflow Soldering Condition

Temperature profile

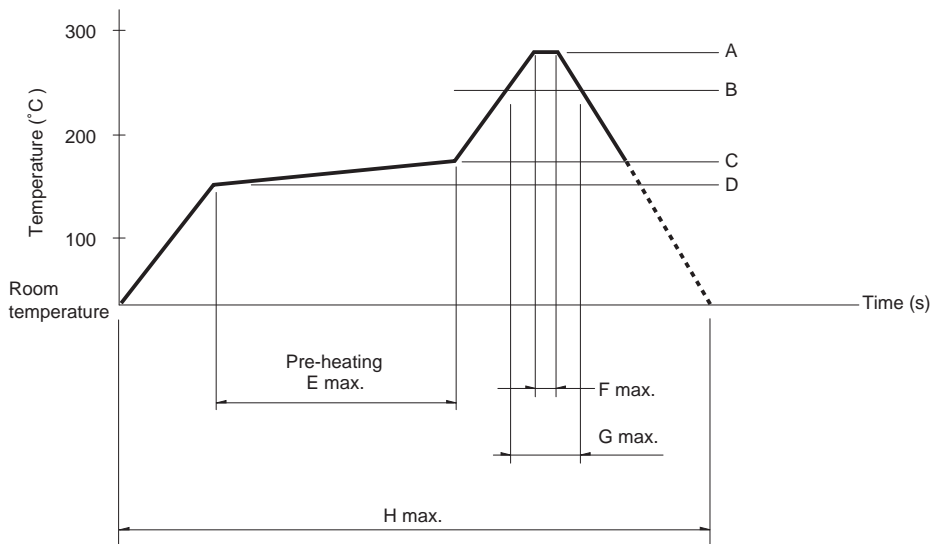

Series	A	B	C	D	E	F	G	H	No. of reflows
RS08U	250°C	200°C	150°C	150°C	2 min.	3s	40s	4 min.	1 time

### Notes

1. When using an infrared reflow oven, solder may sometimes not be applied. Be sure to use a hot air reflow oven or a type that uses infrared rays in combination with hot air.
2. The temperatures given above are the maximum temperatures at the terminals of the products when employing a hot air reflow method. The temperature of the PC board and the surface temperature of the products may vary greatly depending on the PC board material, its size and thickness. Ensure that the surface temperature of the products does not rise to 250°C or greater.
3. Conditions vary to some extent depending on the type of reflow bath used. Be sure to give due consideration to this prior to use.