

SDDJE 10A 250V AC Qualified Type

100A inrush current compatible, compact and large capacity snap-in type with easy mounting

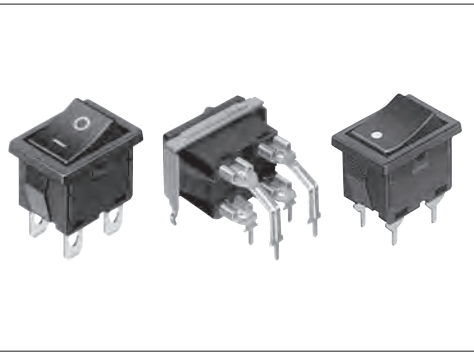

Ratings and Safety Standards

Items	Specifications
C-UL-US	10AGP 250V AC
SEMKO	6A / 96A 250V~, 10(6) / 250~
VDE	6A / 96A 250V~, 10(6) / 250~
BS	6A / 96A 250V~, 10(6) / 250~
Ratings satisfying local electrical appliance and material safety law	125V 10A ∇

Product Line

Circuit arrangement	Travel (mm)	Operating force	Mounting method	Terminal configuration	Frame	Marking (Knob)	Minimum order unit (pcs.)		Product No.	Drawing No.
							Japan	Export		
SPST	3.4	3 \pm 2N	Snap-in	For Lead	Without	Without	400	2,000	SDDJE11600	1
				Right angle	With					
				For Lead	Without	● mark	400	2,000	SDDJE10300	1
				Right angle	With					
				For Lead	Without	IO mark	400	2,000	SDDJE10700	1
				Right angle	With					
				For Lead	Without	-O mark	400	2,000	SDDJE11200	1
				Right angle	With					
DPST	3.4	6 \pm 3N	Snap-in	For Lead	Without	Without	400	2,000	SDDJE31600	3
				Right angle	With					
				For Lead	Without	● mark	400	2,000	SDDJE30100	3
				For PC board						
				Right angle	With		250	1,250	SDDJE30200	4
				SDDJE32100					5	
				For Lead	Without	IO mark	400	2,000	SDDJE30300	3
				For PC board					SDDJE33300	6
				Right angle					SDDJE30500	4
				Right angle	With		250	1,250	SDDJE30400	5
For Lead	Without	-O mark	400	2,000	SDDJE30700		3			

Notes

1. The lead terminals are also used as tab terminals #187 (Use a positive lock connector type).
2. The lead terminal type can be mounted onto a board. (Manual soldering required)
3. Standard products apply Grade V-2 material (Flame Class). For Grade V-0 type please contact us.

Packing Specifications
Tray

Product No.	Number of packages (pcs.)		Export package measurements (mm)
	1 case / Japan	1 case / export packing	
SDDJE11600, SDDJE10300, SDDJE10700, SDDJE11200, SDDJE31600, SDDJE30100, SDDJE32700, SDDJE30200, SDDJE30300, SDDJE33300, SDDJE30500, SDDJE30700	400	2,000	411×328×379
SDDJE12200, SDDJE12300, SDDJE12400, SDDJE12500, SDDJE32000, SDDJE32100, SDDJE30400	250	1,250	

Dimensions

Unit:mm

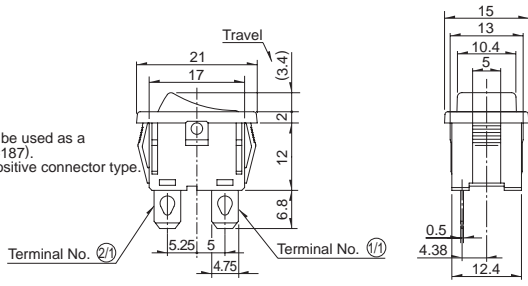
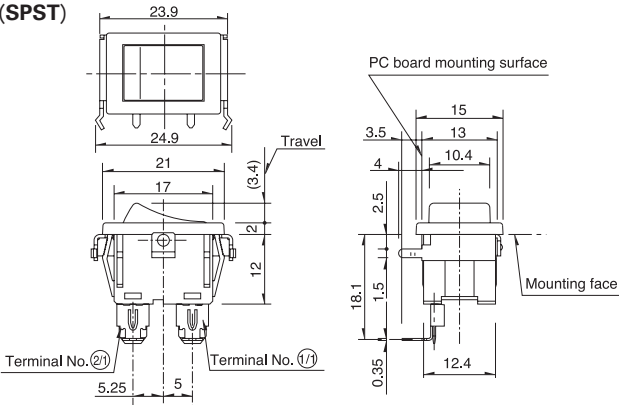
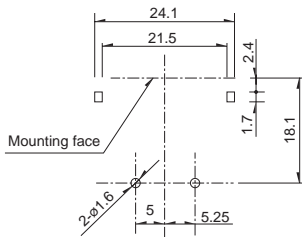
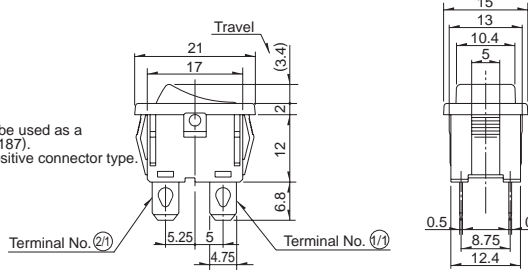
No.	Style (ON position)	
1	<p>For Lead (SPST)</p>  <p>Terminal No. ②① Terminal No. ①①</p>	
2	<p>Right angle (SPST) With frame</p>  <p>Terminal No. ②① Terminal No. ①①</p>	<p>PC board mounting hole dimensions</p> 
3	<p>For Lead (DPST)</p>  <p>Terminal No. ②① Terminal No. ①①</p>	

SDDJE 10A 250V AC Qualified Type

Dimensions

Unit:mm

No.	Style (ON position)	PC board mounting hole dimensions
4	Right angle (DPST) 	
5	Right angle (DPST) With frame 	
6	For PC board (DPST) 	

Circuit Diagram

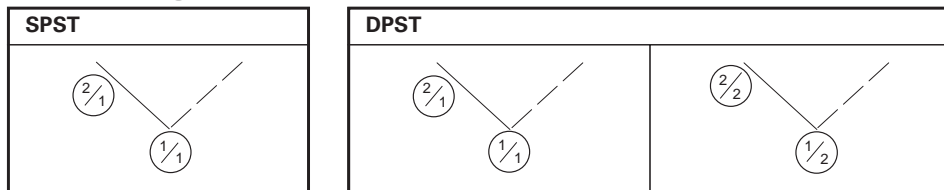

■ Mounting Hole Dimensions

Square-shaped Hole

		Unit:mm	
Thickness of mounting board	Y1	Z	
0.75 to 1.25	$19.2^{0}_{-0.1}$	$12.9^{+0.1}_{0}$	
1.25 to 2.00	$19.4^{0}_{-0.1}$		

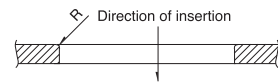
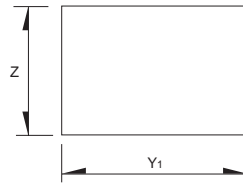

U-shaped Hole

		Unit:mm	
Thickness of mounting board	Y2	Z	
0.75 to 1.1	$19.5^{0}_{-0.1}$	$12.9^{+0.1}_{0}$	
1.1 to 1.7	$19.7^{0}_{-0.1}$		
1.7 to 2	$19.9^{0}_{-0.1}$		

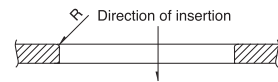
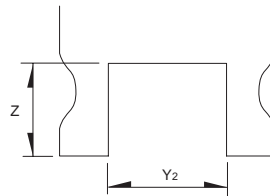

Note

Verify the performance under actual product conditions before use.

■ Marking Variety

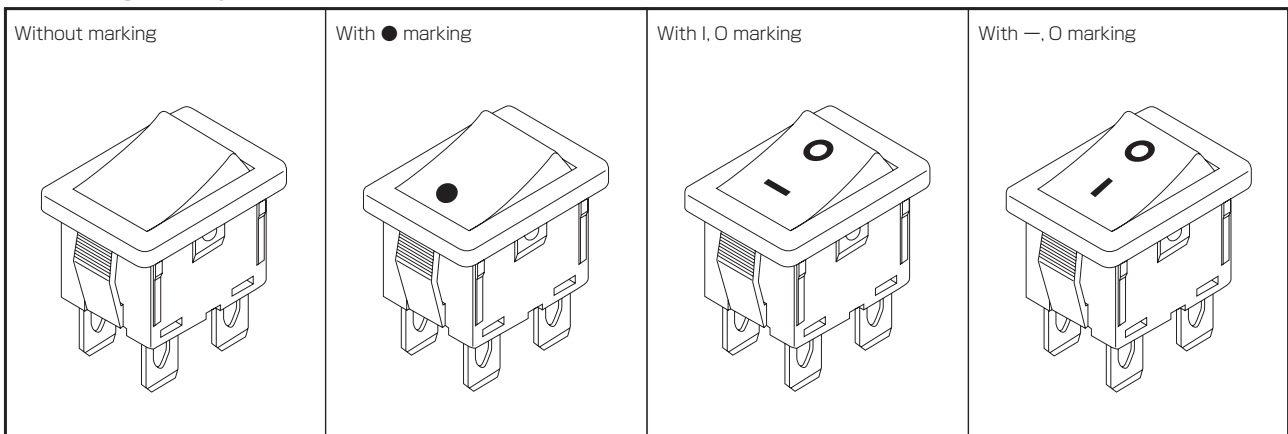

Detector

Slide

Push

Rotary

Power

Dual-in-line Package Type









Push Type

Rocker Type

Rotary Type

Power Switches

List of Varieties

Type		Push		Rocker	Rotary
Series		SDKR	SDDH	SDDJE ※ 1 ※ 2	SDDE
Photo					
Rating		0.5A 250V AC 1A 125V AC 10mA 5V DC	Rating (max.): 4.5A 12V DC (Lamp load: 27Wx2) Rating (min.): 10mA 12V DC (Resistive load)	10AGP 250V AC 6A / 96A 250V~	AC Switch: 1A / 16A 250V ~ DC Switch: 20mA 12V DC Encoders: 0.1A 12V DC
Operating life		100,000cycles	100,000 cycles	10,000cycles	AC Switch: 10,000 cycles DC Switch: 10,000 cycles
		0.5A 250V AC		10A 250V AC	
Travel (mm)		1.5	3.7	3.4	Push Switches: 1.85mm Encoders: 360° (360° Rotation)
Features		Water-proof type With signal circuit	Water-proof (IP68 rating)	—	AC Switch, DC Switch, With Encoder
Operating temperature range		-10°C to +85°C	-15°C to +80°C	-10°C to +55°C	0°C to +85°C
Automotive use		—	●	—	—
Life cycle (availability)					
Electrical performance	Contact resistance	100mΩ max. (AC switch) 500mΩ max. (DC switch)	500mΩ max.	100mΩ max.	AC Switch: 100mΩ max. DC Switch: 500mΩ max. Encoder: 1Ω max.
	Insulation resistance	500MΩ min. 500V DC (AC switch) 100MΩ min. 100V DC (DC switch)	10MΩ min. 500V DC	500MΩ min. 500V DC	AC Switch: 100MΩ min. 500V DC DC Switch: 100MΩ min. 100V DC Encoder: 100MΩ min. 100V DC
	Voltage proof	1000V AC for 1minute (AC switch) 100V AC for 1minute (DC switch)	500V AC for 1minute	2,000V AC for 1minute	AC Switch: 2,000V AC for 1 minute DC Switch: 100V AC for 1 minute Encoder: 100V AC for 1 minute
Mechanical performance	Terminal strength	5N for 1minute	Slider pull-out strength: 100N min.	50N for 1minute (Lead terminal) 5N for 1minute (Right-angle terminal)	AC Switch: 5N for 1 minute DC Switch: 5N for 30s Encoder: 5N for 1 minute
	Actuator strength	Operating direction	100N	—	100N
		Perpendicular direction	20N	—	25N
Environmental performance	Cold	-20°C 240h	-15°C 96h	-20°C 96h	-40°C 240h
	Dry heat	85°C 240h	80°C 96h	85°C 96h	85°C 240h
	Damp heat	60°C, 90 to 95%RH 1000h	40°C, 90 to 95%RH 96h		40°C, 90 to 95%RH 240h
Page		148	149	150	154

Power Switches Soldering Conditions	155
Power Switches Cautions	155
Power Switches Safety Standard	155

Notes

- ※ 1. Dip soldering can be used on SDDJE for PC board terminal and SDDJF right angle terminal types only.
- ※ 2. The operating temperature range can be raised upon request. Please contact us for details.
- Indicates applicability to all products in the series.

Reference for Hand Soldering

Series	Soldering temperature	Soldering time
SDDJE, SDDE	350±10℃	3+1/0s
SDKR	300±10℃	3±0.5s

Reference for Dip Soldering

(For PC board terminal types and SDDJF right-angle terminal types)

Series	Dip soldering	
	Soldering temperature	Duration of immersion
SDKR, SDDJE, SDDE	260±5℃	10±1s

Power Switches / Cautions

1. The primary power supply switching is subject to the safety regulations, and the provisions differ by each destination. Consult with us for non-standard use cases.
2. An unstable contact may occur if the switch current is lower than 0.5A. For this case, consult with us.
3. These power switches were produced for alternating current. For direct current, consult with us.
4. Applying load to terminals during soldering under certain conditions may cause deformation and electrical property degradation.
5. Avoid use of water-soluble soldering flux, since it may corrode the switches.
6. When soldering twice, wait until the first soldered portion cools to normal temperature. Continuous heating will deform the external portions, loosen or dislodge terminals, or may deteriorate their electrical characteristics.
7. Before soldering switches with locking mechanism, release the locks. If they are soldered without releasing the locks, the soldering heat may deform the locking mechanism.
8. Be sure to release the locks before removing the knobs. Otherwise, the locking mechanism may be broken.
9. Be sure to use the switch with forced travel positioned as close to the total travel as possible.
10. Tighten the mounting screws by applying the specified torque. Tightening with a larger torque than the specified will result in malfunction or breakage of screws.
11. Corrosive gas if generated by peripheral parts of a set, malfunction such as imperfect contact may occur. Thorough investigation shall be required beforehand.
12. Storage
Store the products as delivered at normal temperature and humidity, out of direct sunlight and away from corrosive gases. Use them as soon as possible and no later than six months after delivery. Once the seal is broken, use them as soon as possible.

Power Switches / Safety Standards

1. Safety Standards Outline

Safety standards are established by a country or an organization representing it to protect general users from electrical shock and fire hazards. It establishes standards for electrical devices and components. For electrical equipment manufacturers, utilizing switches that have been safety-approved ensures the safety of the switch. The use of a safety-approved switch also simplifies at least one part of the process of obtaining certification by safety testing.

2. Major Safety Standards

(1) Electrical Appliance and Material Safety Law

The conventional [Electrical Appliance and Material Control Law] has changed to [Electrical Appliance and Material Safety Law] and has been enforced since April 1, 2001. Electrical appliances are categorized into special electric appliances and parts (formerly Class A) and Electrical appliances other than the special electric appliances (formerly Class B). Special electric appliances are required to receive goodness of fit test at a certified test agency and to store the certificate. Also, penal provisions have been reinforced.

(2) UL (Underwriters Laboratories Inc.)

Underwriters Laboratories Inc. (UL) is the American safety approving organization. Its purpose is to ensure consumer safety and protect them from fire hazards. State law requires that equipment to be exported to the United States utilize UL approved power switches or power switches meeting UL standards and capable of passing UL tests.