

Heavy operating force, soft feeling type achieves low contact resistance through adopting metal contacts



TACT Switch™

Sharp Feeling

Soft Feeling

Snap-In Type

Surface Mount Type

Radial Type

Typical Specifications



Items	Specifications
Rating (max.)	50mA 16V DC
Rating (min.)	10 μ A 1V DC
Initial contact resistance	100m Ω max.
Travel (mm)	1.0

Product Line

Product No.	Operating force	Operating direction	Operating life (1mA 5V DC)	Minimum order unit (pcs.)	
				Japan	Export
SKPRAAE010	5N	Top push	100,000 cycles	1,050	1,050

Packing Specifications

Taping

Number of packages (pcs.)			Tape width (mm)	Export package measurements (mm)
1 reel	1 case / Japan	1 case / export packing		
1,050	6,300	6,300	24	395×395×205

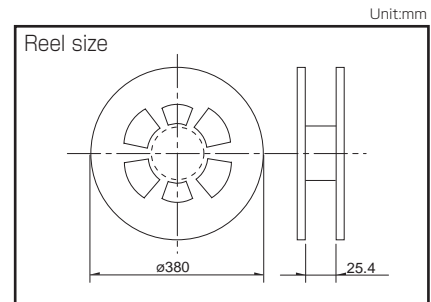

Note

For reels of 330mm diameter, please inquire.

Dimensions

Style	PC board land dimensions (Viewed from switch mounting face)

Circuit Diagram

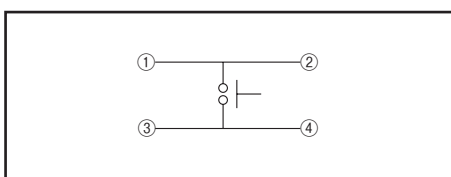

Refer to P.235 for soldering conditions.

TACT Switch™

List of Varieties

TACT Switch™

















Sharp Feeling

Soft Feeling

Snap-In Type

Surface Mount Type

Radial Type

Type		Sharp Feeling Type			Soft Feeling Type				
		Surface Mount			Snap-in	Surface Mount			
Series		SKSC	SKRT	SKRH	SKPF	SKPS	SKPM	SKPG	SKPR
Photo									
Features		Low-profile	—	4-direction switch + push switch	High operation force Long travel	Low contact resistance		—	High operation force Low contact resistance
Water-proof		—	—	—	—	—	—	—	—
Dustproof		—	—	—	—	—	—	—	—
IP standard		—	—	—	—	—	—	—	—
Operating direction	Top push	—	—	●	●	●	●	●	●
	Side push	●	●	●	—	—	—	—	—
Dimensions (mm)	W	3.5	4.5	7.35	8	5.9		6.6	7.5
	D	3.55	3.4	7.5	9	6		6.3	7.8
	H	1.25	3.3	5	10	5		—	6.5
Contact		—	—	—	Carbon	Silver		Carbon	Silver
Operation force coverage	1N max.	—	—	—	—	—	—	—	—
	1N to 2N	↕	↕	See the relevant pages for respective product descriptions	↕	—	↕	↕	—
	2N to 3N	↕	—		↕	↕	—	—	—
	3N to 4N	—	—		—	—	—	—	—
4N to 5N	—	—	—		—	—	—	↕	
Travel (mm)		0.2		1.75	See the relevant pages for respective product descriptions	1.05	1.3		1
Ground terminal		○	●	●	—	—	—	—	—
Operating temperature range		−30°C to +85°C	−40°C to +90°C	−40°C to +85°C	−40°C to +90°C				
Automotive use		—	—	—	●	●	●	●	●
Life Cycle									
Electrical performance	Rating (max.) (Resistive load)	50mA 12V DC			50mA 16V DC		5mA 12V DC	50mA 16V DC	
	Rating (min.) (Resistive load)	10μA 1V DC							
	Insulation resistance	100MΩ min. 100V DC 1min.							
	Voltage proof	100V AC 1min.	250V AC 1min.	100V AC 1min.	250V AC 1min.				
Durability	Vibration	10 to 55 to 10Hz/min., the amplitude is 1.5mm for all the frequencies, in the 3 direction of X, Y and Z for 2 hours respectively							
	Lifetime	Shall be in accordance with individual specifications.							
Environmental performance	Cold	−40°C 96h			−40°C 1,000h		−40°C 96h	−40°C 1,000h	
	Dry heat	90°C 96h			90°C 1,000h		90°C 96h	90°C 1,000h	
	Damp heat	60°C, 90 to 95%RH 96h			60°C, 90 to 95%RH 1,000h		60°C, 90 to 95%RH 96h	60°C, 90 to 95%RH 1,000h	
Page		225	227	405	230	231	232	233	234

W : Width. The most outer dimension excluding terminal portion.
D : Depth. The most outer dimension excluding terminal portion.
H : Height. The minimum dimension if there are variances.

TACT Switch™ Soldering Conditions 235
TACT Switch™ Cautions 236

Notes

- The automotive operating temperature range to be individually discussed upon request.
- Indicates applicability to all products in the series, while ○ indicates applicability to some products in the series.

Condition for Reflow

Available for Surface Mount Type.

Temperature profile

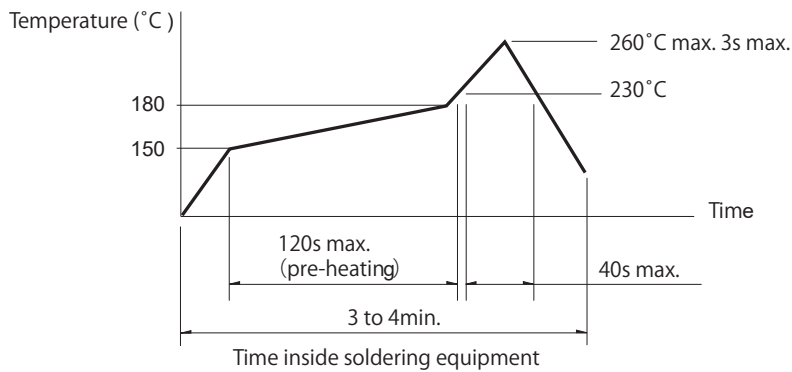

Notes

1. Please confirm the specifications of our product for the detailed condition.
2. Soldering conditions differ depending on reflow soldering machines.
Prior verification of soldering condition is highly recommended.

Conditions for Auto-dip

Available for Snap-in Type and Radial Type.

Items	Condition
Flux built-up	Mounting surface should not be exposed to flux
Preheating temperature	Ambient temperature of the soldered surface of PC board. 100°C max.
Preheating time	60s max.
Soldering temperature	260°C max.
Duration of immersion	5s max.
Number of soldering	2times max.

SKHH Series

Items	Condition
Flux built-up	Mounting surface should not be exposed to flux
Preheating temperature	Ambient temperature of the soldered surface of PC board. 110°C max.
Preheating time	60s max.
Soldering temperature	260°C max.
Duration of immersion	5s max.
Number of soldering	2times max.

SKHL Top Push Type, SKQJ Series

Items	Condition
Flux built-up	Mounting surface should not be exposed to flux
Preheating temperature	Ambient temperature of the soldered surface of PC board. 100°C max.
Preheating time	45s max.
Soldering temperature	255°C max.
Duration of immersion	5s max.
Number of soldering	2times max.

Notes

1. Prevent flux penetration from the top side of the TACT Switch™.
2. Switch terminals and a PC board should not be coated with flux prior to soldering.
3. The second soldering should be done after the switch is stable with normal temperature.
4. Use the flux with a specific gravity of min 0.81.
(EC-19S-8 by TAMURA CORPORATION, or equivalents.)

Manual Soldering

Items	Condition
Soldering temperature	350°C max.
Duration of soldering	3s max.
Capacity of soldering iron	60W max.

SKHH, SKHW Series

Items	Condition
Soldering temperature	360°C max.
Duration of soldering	3s max.
Capacity of soldering iron	60W max.

SKTD, SKTG, SKQJ, SKSN Series

Items	Condition
Soldering temperature	350°C max.
Duration of soldering	3s max.
Capacity of soldering iron	20W max.