

Miniature Slide

Specifications

Electrical Ratings	5A @ 120VAC, 28VDC; 2A @ 250VAC see contact options	Dielectric Strength	1500Vrms min
Electrical Life	30,000 cycles typical	Insulation Resistance	>100MΩ min
Contact Resistance	<10mΩ max initial @ 2-4VDC, 100mA	Operating Temperature	-40°C to 85°C
		Storage Temperature	-40°C to 85°C

Materials

Actuator	6/6 Nylon
Housing	Diallyl Phthalate (DAP)
Cover	Stainless Steel
Contacts	Copper Alloy, Silver Plated
Terminals	Brass, Silver Plated

Ordering Information

1. Series	1	2	03	A1	B	C	E	B
2. Number of Poles								
3. Switch Function								
4. Actuator								
5. Terminals								
6. Contacts								
7. Epoxy Seal								
8. Mounting Style								

Switch Function



SPDT



Function	Toggle Position		
1	ON	NONE	ON
2	ON	NONE	(ON)
3	ON	OFF	ON
Terminals	2-3	n/a	2-1

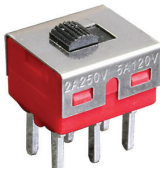
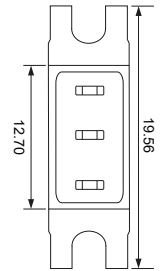
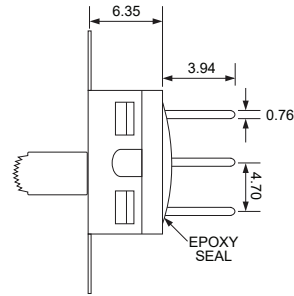
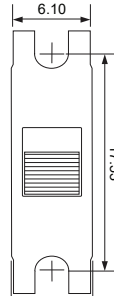

DPDT

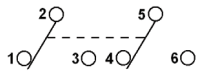

Function	Toggle Position		
1	ON	NONE	ON
2	ON	NONE	(ON)
3	ON	OFF	ON
Terminals	2-3 5-6	n/a	2-1 5-4

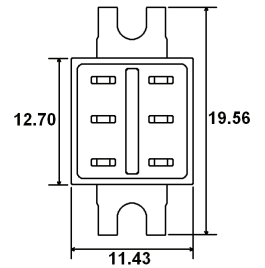
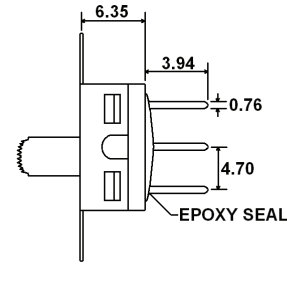
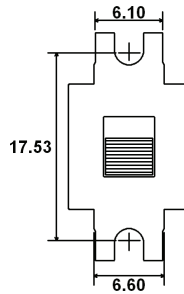

Actuator Options

****Actuator lengths shown with B, C, d or S20 terminals, subtract 0.36mm for H or V terminals**

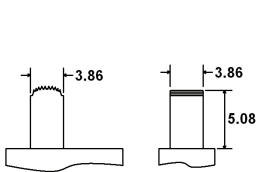

A1

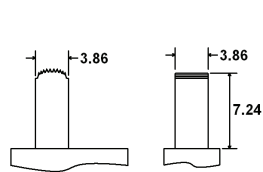

A2

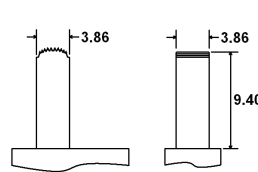

A3

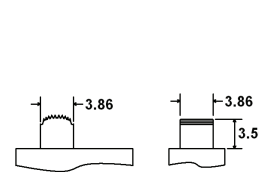

A4

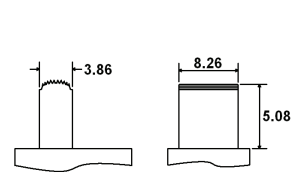

D1

Terminal Options

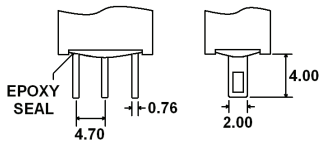

B Single Pole

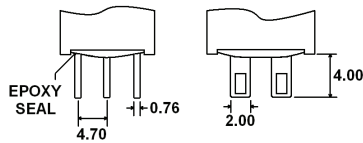

B Double Pole

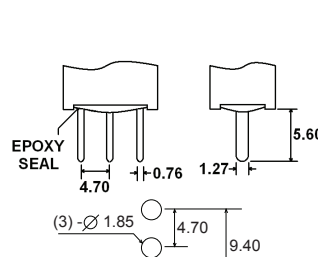

C Single Pole

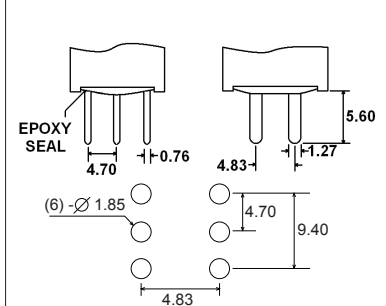

C Double Pole

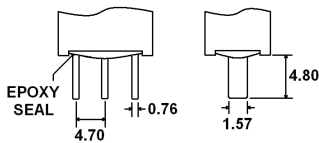

D Single Pole

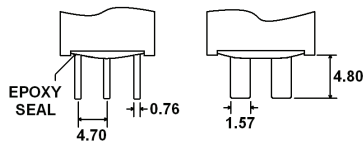

D Double Pole

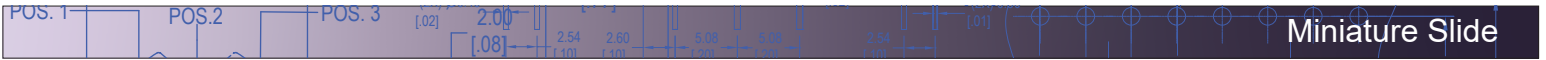

Terminal Options

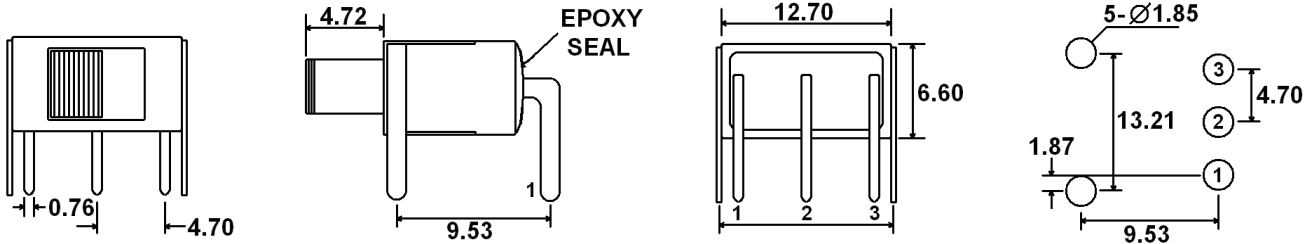

H = Horizontal Mount, Right Angle PC Pins, Single Pole

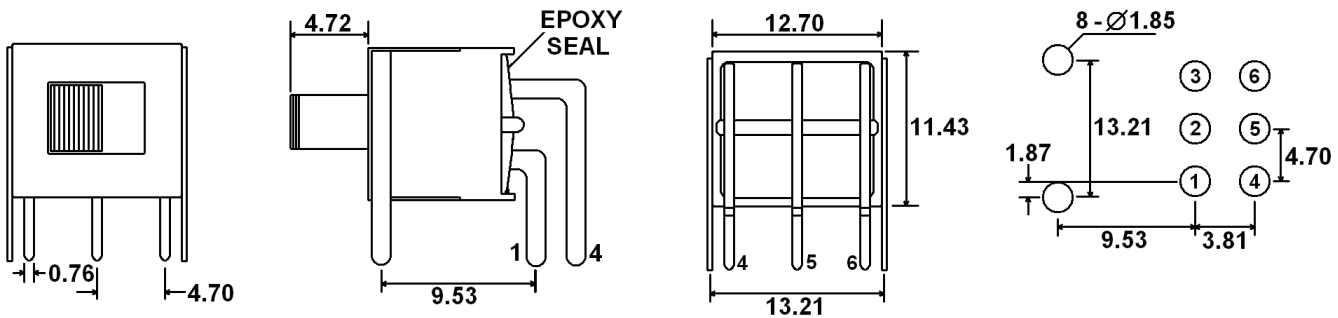

H = Horizontal Mount, Right Angle PC Pins, Double Pole

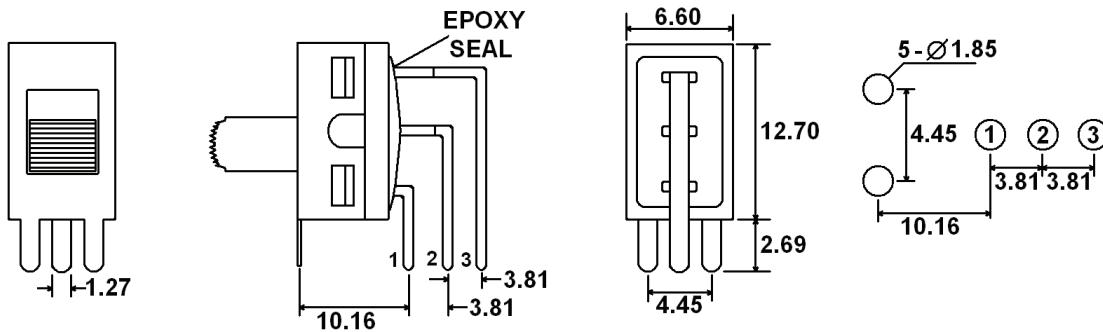

V = Vertical Mount, Right Angle PC Pins, Single Pole

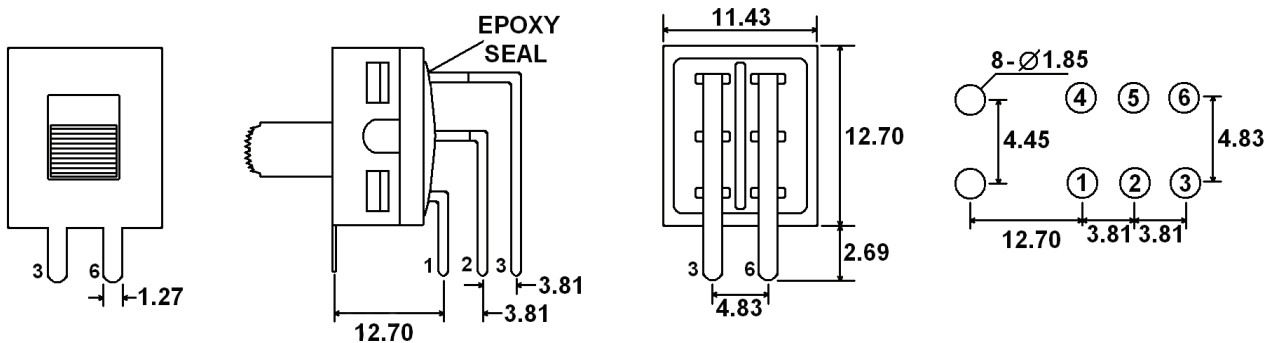

V = Vertical Mount, Right Angle PC Pins, Double Pole

Terminal Options

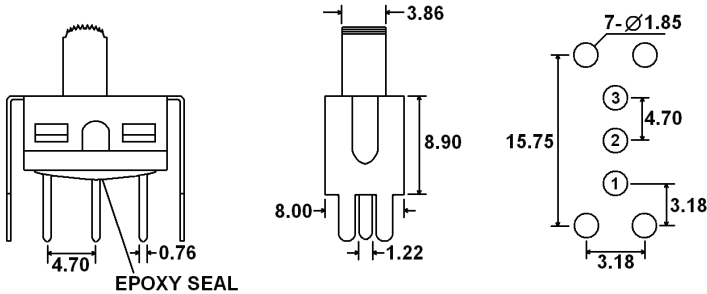

S20 = PC Pins with Support Bracket, Single Pole

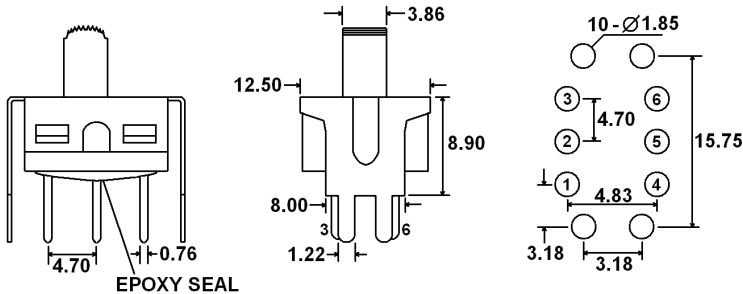

S20 = PC Pins with Support Bracket, Double Pole

Contact Options

Designator	Contact Material	Terminal Material	Electrical Rating
Q	Silver Plating	Silver Plating	5A @ 120VAC, 28VDC; 2A @ 250VAC
R	Gold over Nickel Plating	Gold over Nickel Plating	.4VA max @ 20VAC or VAC max
G	Gold over Silver Plating	Gold over Silver Plating	.4VA max @ 20VAC or VAC MAX or 5A @ 120VAC, 28VDC; 2A @ 250VAC

Mounting Options

**For A1, A2, A3 & A4
Switch Functions 1 & 2**

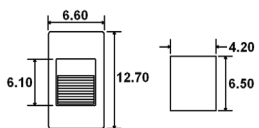

A - No Mounting Ears

**For D1
Switch Functions 1 & 2**

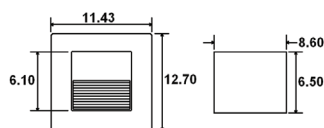

A - No Mounting Ears

**For A1, A2, A3 & A4
Switch Functions 3**

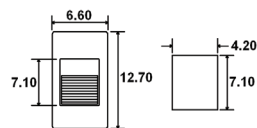

A - No Mounting Ears

**For D1
Switch Functions 3**

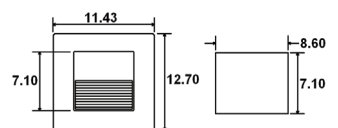

A - No Mounting Ears

**For A1, A2, A3 & A4
Switch Functions 1 & 2**

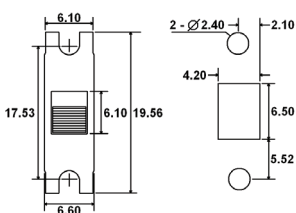

B - Mounting Ears

**For D1
Switch Functions 1 & 2**

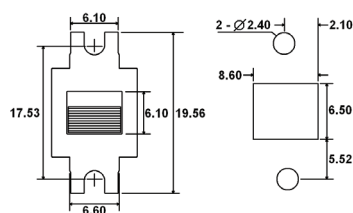

B - Mounting Ears

**For A1, A2, A3 & A4
Switch Functions 3**

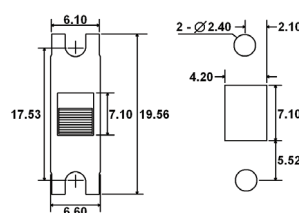

B - Mounting Ears

**For D1
Switch Functions 3**

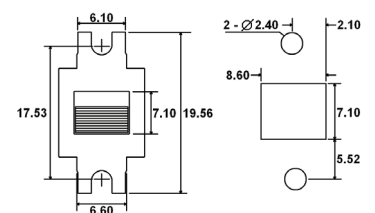

B - Mounting Ears