

E222871

Miniature Pushbutton

Specifications

| | | | |
|--------------------|--|-----------------------|---------------|
| Electrical Ratings | 3A @ 120VAC, 28VDC 1A @ 250VAC See Contact Options | Dielectric Strength | 1500Vrms min |
| Electrical Life | 50,000 cycles typical | Insulation Resistance | >100MΩ min |
| Contact Resistance | <20mΩ initial @ 2-4VDC, 100mA | Operating Temperature | -40°C to 85°C |
| Actuator Travel | 0.85mm ± 0.2mm | Storage Temperature | -40°C to 85°C |

Materials

| | |
|-----------|-------------------------|
| Actuator | 6/6 Nylon, Glass Filled |
| Housing | Diallyl Phthalate (DAP) |
| Cover | Stainless Steel |
| Bushing | Brass, Nickel Plated |
| Contacts | Brass, Silver Plated |
| Terminals | Brass, Silver Plated |

Ordering Information

| | | | | | | | | |
|---|-----|---|---|----|---|---|---|--|
| 1. Series | ANP | 2 | 1 | F4 | C | Q | E | C742 |
| ANP | | | | | | | | |
| 2. Number of Poles | | | | | | | | |
| 1 = SPDT | | | | | | | | |
| 2 = DPDT | | | | | | | | |
| 3. Switch Function | | | | | | | | |
| 1 = ON - (ON) | | | | | | | | |
| 2 = ON - ON Latching | | | | | | | | |
| 4. Bushing | | | | | | | | |
| F4 / N4 = ¼-40NS / Non-threaded, keyway, 6.35mm | | | | | | | | |
| F9 / N9 = ¼-40NS / Non-threaded, flat, 6.35mm | | | | | | | | |
| **No bushing is selected is a panel mount frame is selected below | | | | | | | | |
| 5. Terminals | | | | | | | | |
| B = Solder Lug | | | | | | | | |
| C = PC pin | | | | | | | | |
| D = Quick connect | | | | | | | | |
| H = Horizontal mount, right angle PC pin; HS = Snap In | | | | | | | | |
| V = Vertical mount, right angle PC pin | | | | | | | | |
| S20 = PC pin with support bracket; V20 = Snap in support bracket *not available with SPDT | | | | | | | | |
| S25 = PC pin with support bracket; V25 = Snap in support bracket | | | | | | | | |
| S40 = PC pin with support bracket; V40 = Snap in support bracket | | | | | | | | |
| 6. Contacts | | | | | | | | |
| Q = Silver plated | | | | | | | | |
| R = Gold plated | | | | | | | | |
| G = Gold over Silver plated | | | | | | | | |
| 7. Epoxy Seal | | | | | | | | |
| E = Epoxy Seal | | | | | | | | |
| 8. Actuator Cap / Frame | | | | | | | | |
| Blank = None | | | | | | | | |
| C73 | | | | | | | | F75 = Snap in panel mount with frame <i>only available with momentary option</i> |
| C74 | | | | | | | | F76 = Snap in panel mount with frame <i>only available with momentary option</i> |
| C75 | | | | | | | | |
| C76 | | | | | | | | |
| C77 | | | | | | | | |

Miniature Pushbutton

Switch Function



SPDT



| Function | Pushbutton Position | |
|-----------|---------------------|------|
| | | |
| 1 | ON | (ON) |
| 2 | ON | ON |
| Terminals | 1-3 | 1-2 |

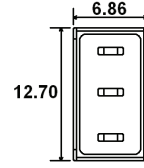
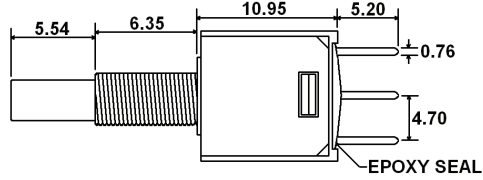
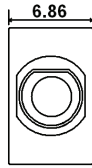

DPDT

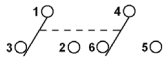

| Function | Pushbutton Position | |
|-----------|---------------------|------------|
| | | |
| 1 | ON | (ON) |
| 2 | ON | ON |
| Terminals | 1-3 4-6 | 1-2 4-5 |

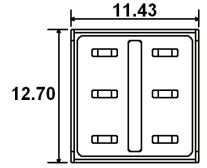
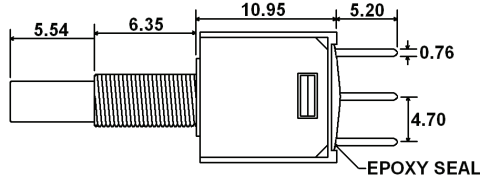
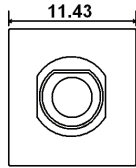

Bushing Options

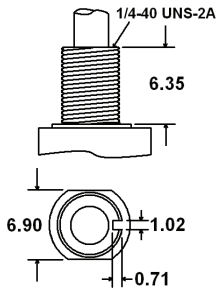

**F4 Threaded
N4 Non-Threaded**

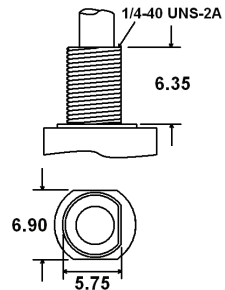

**F9 Threaded
N9 Non-Threaded**

Panel Mounting

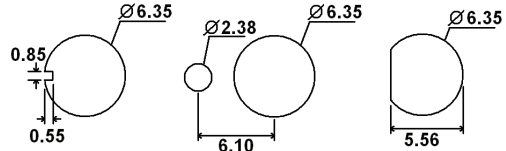

1/4" - 40 Bushing

Terminal Options

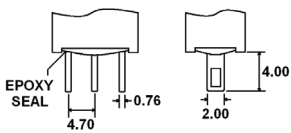

B Single Pole

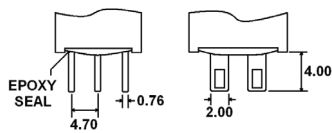

B Double Pole

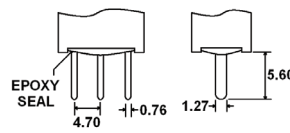

C Single Pole

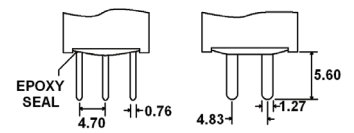

C Double Pole

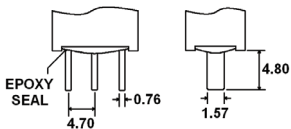

D Single Pole

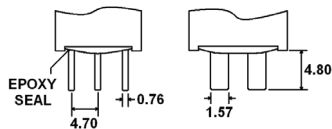

D Double Pole

Terminal Options

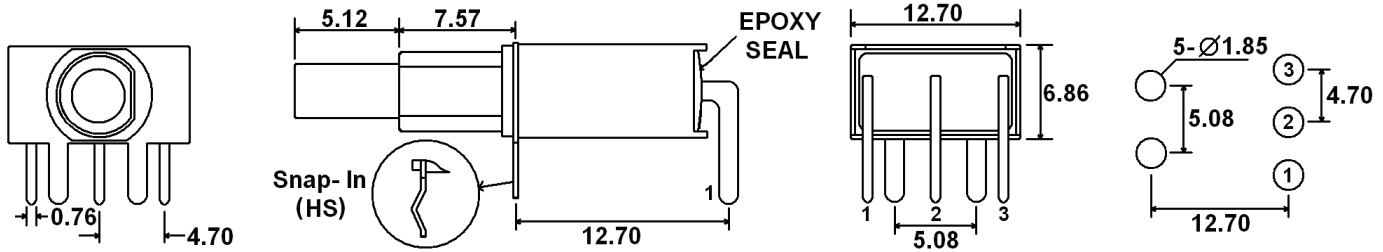

H (HS - Snap In) = Horizontal mount, right angle PC pins, single pole

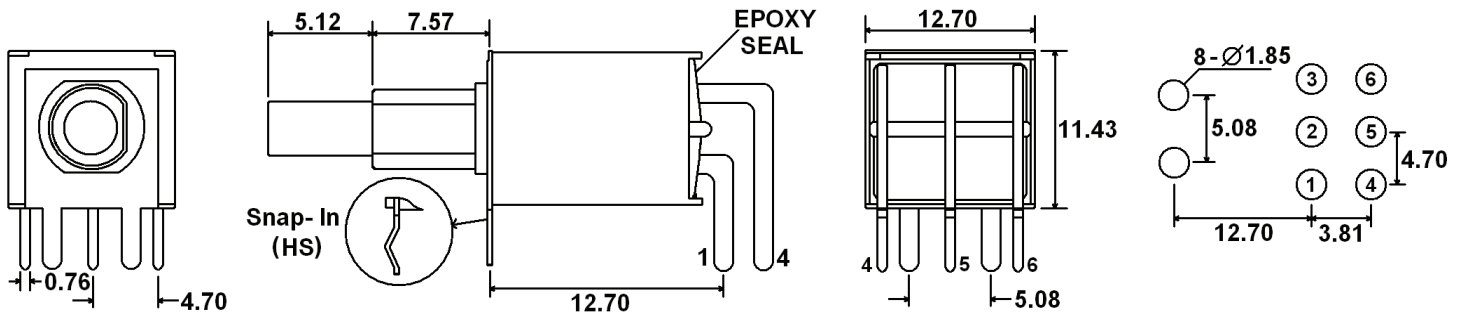

H (HS - Snap In) = Horizontal mount, right angle PC pins, double pole

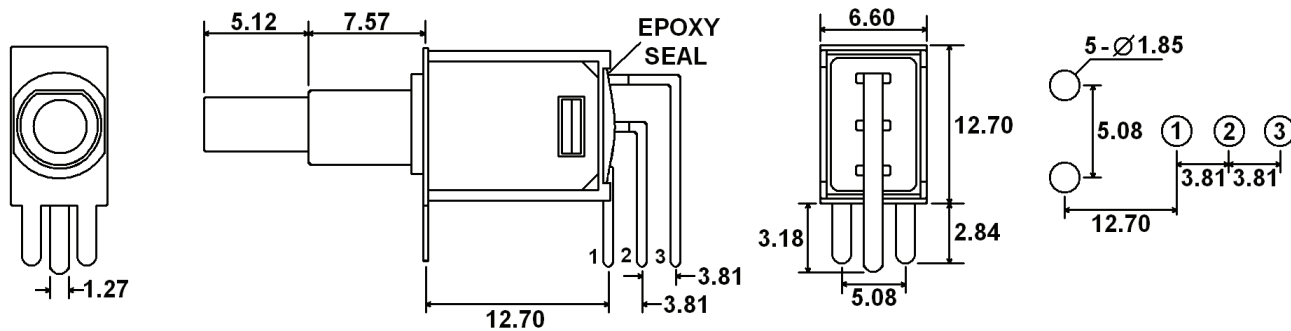

V = Vertical mount, right angle PC pins, single pole

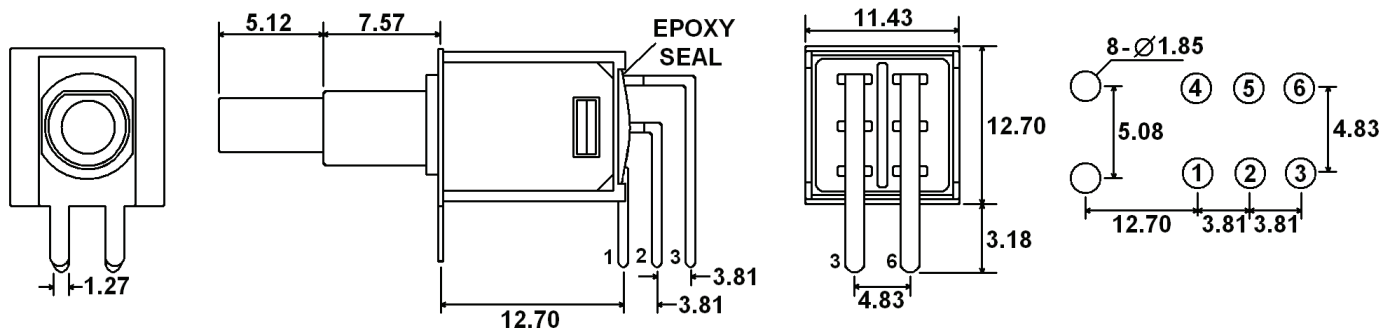

V = Vertical mount, right angle PC pins, double pole

Terminal Options

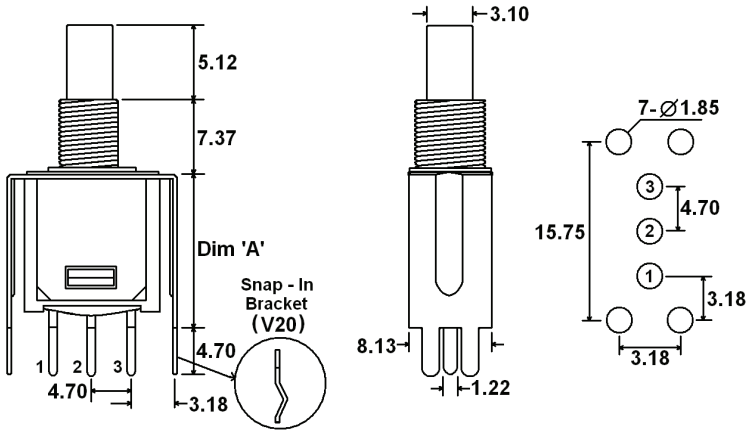

| Terminal Option | "A" Dimension |
|-----------------|---------------|
| S25 / V25 | 16.00 |

S25 (V25 - Snap in bracket) = PC pins with support bracket, single pole

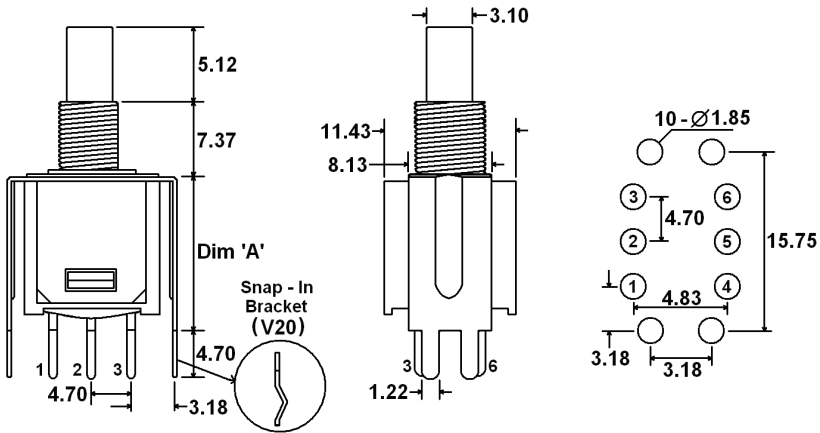

| Terminal Option | "A" Dimension |
|-----------------|---------------|
| S20 / V20 | 11.68 |
| S25 / V25 | 16.00 |

S20 / S25 (V20/V25 - Snap in bracket) = PC pins with support bracket, double pole

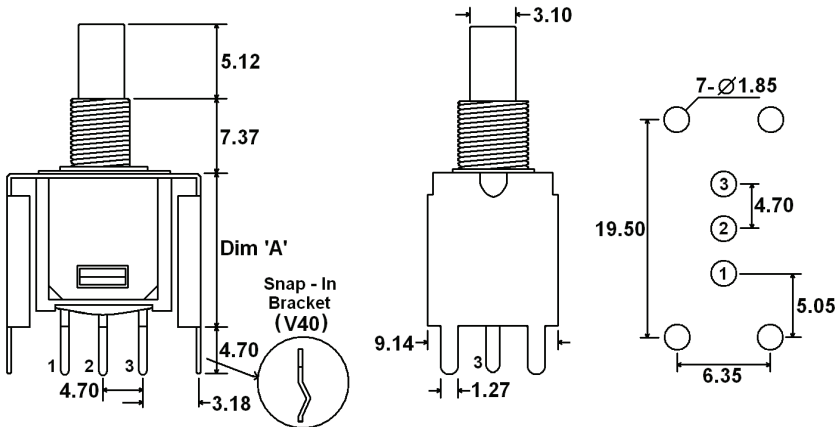

| Terminal Option | "A" Dimension |
|-----------------|---------------|
| S40 / V40 | 16.00 |

S40 (V40 - Snap in bracket) = PC pins with support bracket, single pole

Terminal Options

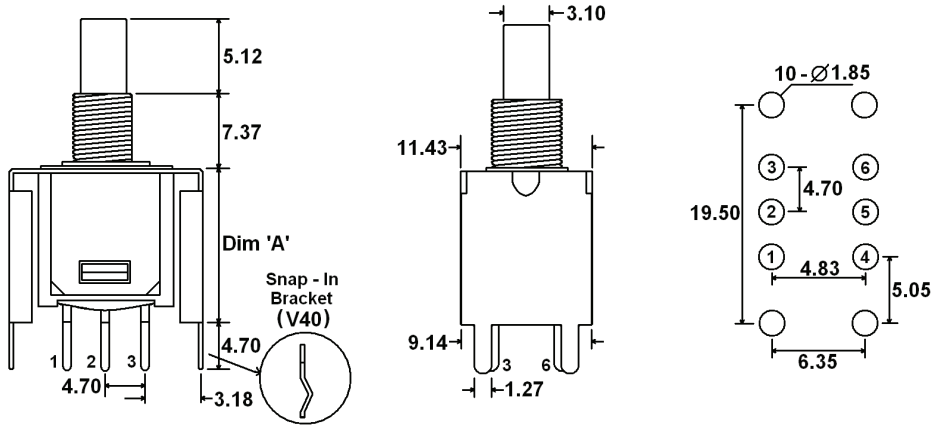

| Terminal Option | "A" Dimension |
|-----------------|---------------|
| S40 / V40 | 16.00 |

S40 (V40 - Snap in bracket) = PC pins with support bracket, double pole

Contact Options

| Designator | Contact Material | Terminal Material | Electrical Ratings |
|------------|--------------------------|--------------------------|---|
| Q | Silver Plating | Silver Plating | 3A @ 120VAC, 28VDC; 1A @ 250VAC |
| R | Gold over Nickel Plating | Gold over Nickel Plating | 0.4VA max @ 20VAC or VDC max |
| G | Gold over Silver Plating | Gold over Silver Plating | 0.4VA max @ 20VAC or VDC max or 3A @ 120VAC, 28VDC; 1A @ 250VAC |

Cap Options

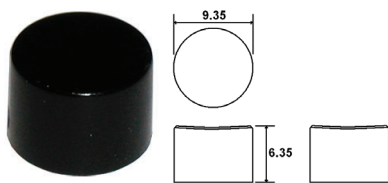

C73_

1 = White, 2 = Black, 3 = Red
Contact Factory for other available colors

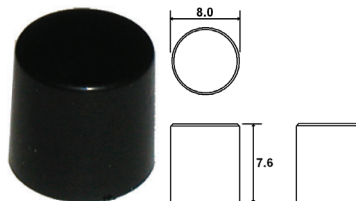

C74_

1 = White, 2 = Black, 3 = Red
Contact Factory for other available colors

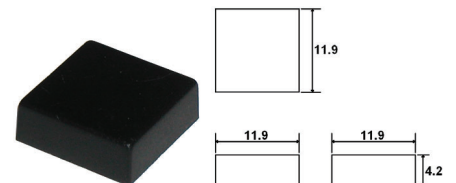

C75_

1 = White, 2 = Black, 3 = Red
Contact Factory for other available colors

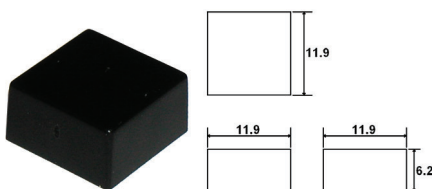

C76_

1 = White, 2 = Black, 3 = Red, 9
Contact Factory for other available colors

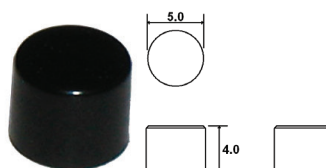

C77_

1 = White, 2 = Black, 3 = Red
Contact Factory for other available colors

Frame Options

F75__ ← Insert cap and frame colors here

Increase the length dimension to 15.75 / 15.88 for 1.5 / 3.2 thick panels

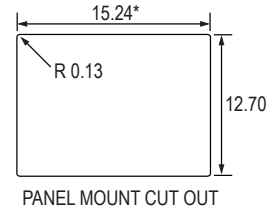
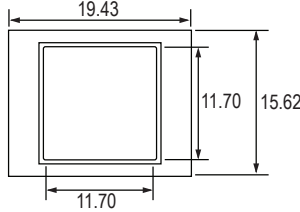
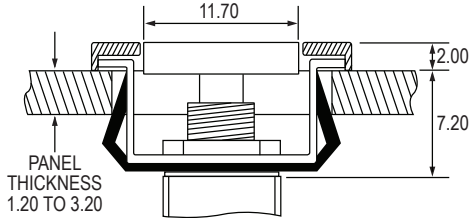

Cap Color / Frame Color
1 = White, 2 = Black, 3 = Red
Contact Factory for other available colors

F76__ ← Insert cap and frame colors here

Increase the length dimension to 15.75 / 15.88 for 1.5 / 3.2 thick panels

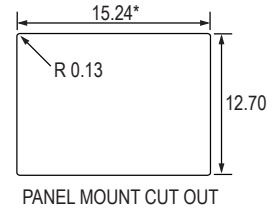
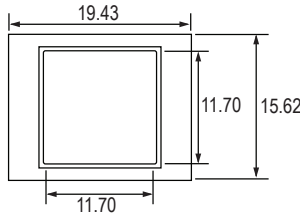
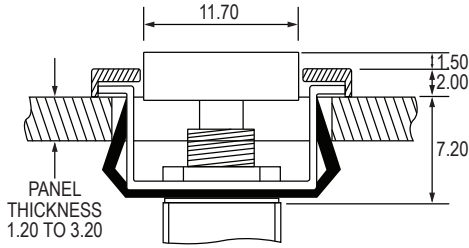

Cap Color / Frame Color
1 = White, 2 = Black, 3 = Red
Contact Factory for other available colors

Hardware

Two hex nuts, one lock washer & one locking ring supplied standard with threaded bushings

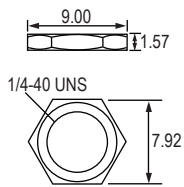

Hex Nut

For use with F4 & F9
Bushing

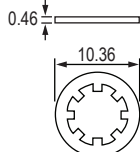

Lock Washer

For use with F4 & F9
Bushing

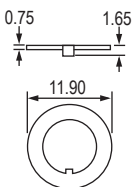

Locking Ring

For use with F4 & F9
Bushing

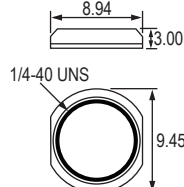

Dress Nut

For use with F4 & F9
Bushing

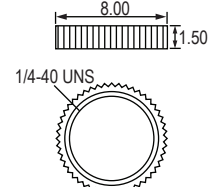

Knurled Nut

For use with F4 & F9
Bushing

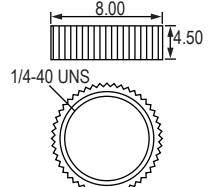

Knurled Nut

For use with F4 & F9
Bushing

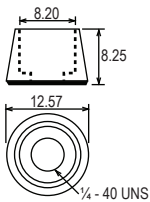

Cap Shroud A

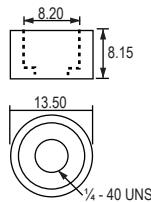

Cap Shroud B

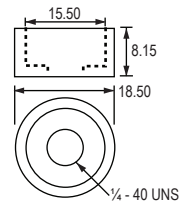

Cap Shroud C