

Specifications

Electrical Ratings	3A @ 120VAC, 28VDC 1A @ 250VAC See Contact Options	Dielectric Strength	1500Vrms min
Electrical Life	30,000 cycles typical	Insulation Resistance	>100MΩ min
Contact Resistance	<20mΩ initial @ 2-4VDC, 100mA	Operating Temperature	-40°C to 85°C
		Storage Temperature	-40°C to 85°C

Materials

Actuator	6/6 Nylon
Housing	Diallyl Phthalate (DAP)
Cover	Stainless Steel
Bushing	Brass, Nickel Plated
Contacts	Copper Alloy, Silver Plated
Terminals	Brass, Silver Plated

Ordering Information

1. Series	BNR	1	3	R1	2			C	Q	E
BNR										
2. Number of Poles										
1 = SPDT										
2 = DPDT										
3. Switch Function										
1 = ON-NONE-ON										
2 = ON-NONE-(ON)										
3 = ON-OFF-ON										
4 = (ON)-OFF-(ON) **Only available in SPDT										
5 = ON-OFF-(ON) **Only available in SPDT										
4. Actuator										
R1 = Rocker, Panel mount										
R2 = Rocker, Panel mount										
R1P = Rocker, PC mount										
R2P = Rocker, PC mount										
5. Actuator Color										
1 = White	2 = Black		3 = Red							
6. Actuator Marking Style										
Blank = No Marking										
A, B or C										
7. Actuator Marking Color										
Blank = No marking										
W = White, standard										
B = Black										
8. Terminals										
B = Solder Lugs										
C = PC pin										
H = Horizontal mount, right angle PC pin; HS = Snap-in										
V = Vertical mount, right angle PC pin; VS = Snap-in										
A5 = PC pin with support bracket; A5S = Snap-in support bracket										
9. Contacts										
Q = Silver plated										
R = Gold plated										
G = Gold over Silver plated										
10. Epoxy Seal										
E = Epoxy Seal										

Switch Function

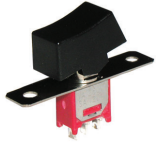

SPDT



Function	Rocker Position		
1	ON	NONE	ON
2	ON	NONE	(ON)
3	ON	OFF	ON
4	(ON)	OFF	(ON)
5	ON	OFF	(ON)
Terminals	2-3	-	2-1

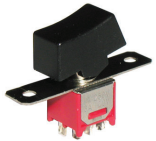
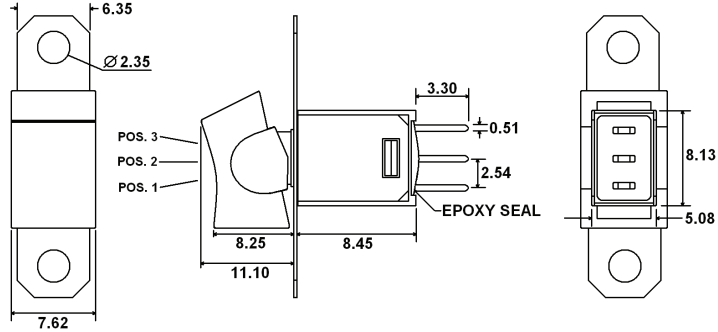

DPDT

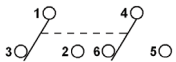

Function	Rocker Position		
1	ON	NONE	ON
2	ON	NONE	(ON)
3	ON	OFF	ON
Terminals	2-3	-	2-1

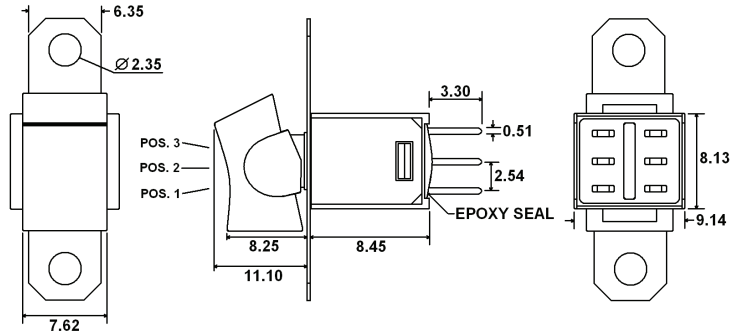

Actuator Options

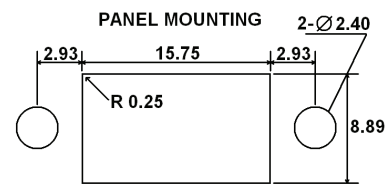
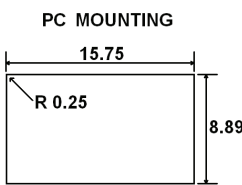
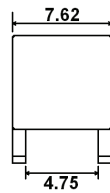
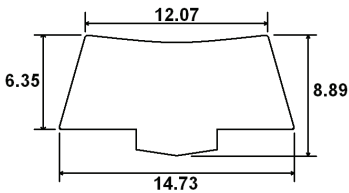

R1 / R1P

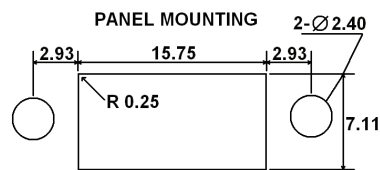
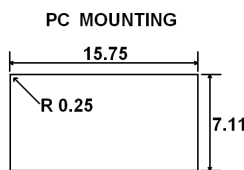
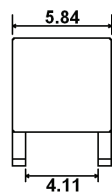
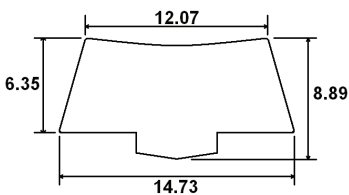

R2 / R2P

Actuator Markings

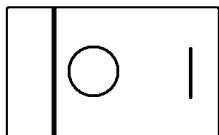

A

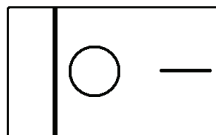

B

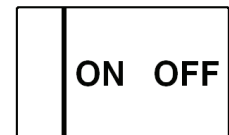

C



Terminal Options

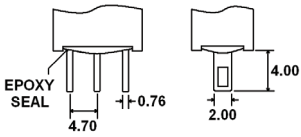

B - SPDT

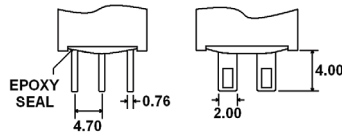

B - DPDT

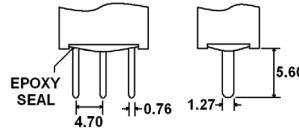

C - SPDT

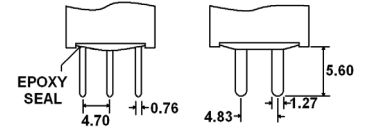

C - DPDT

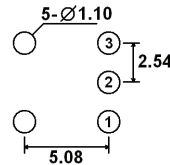
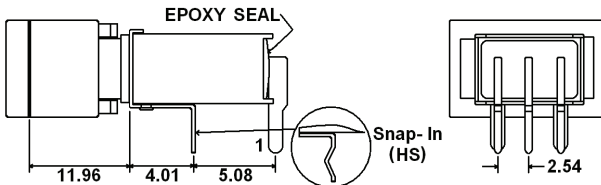
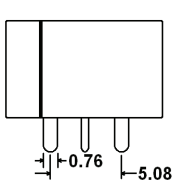
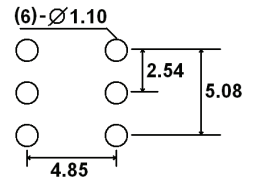
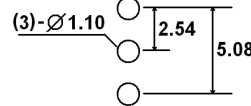

H (HS - Snap In) = Horizontal mount, right angle PC pins, single pole

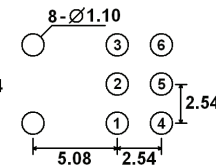
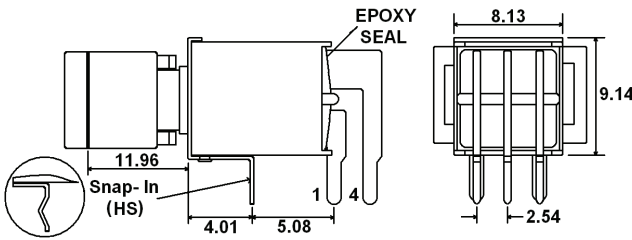
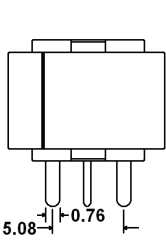

H (HS - Snap In) = Horizontal mount, right angle PC pins, double pole

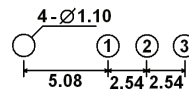
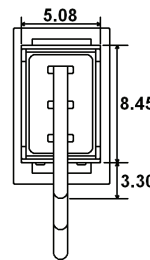
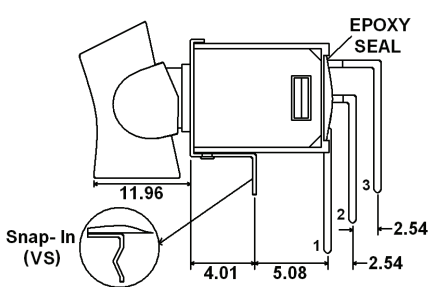
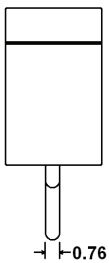

V (VS - Snap In) = Vertical mount, right angle PC pins, single pole

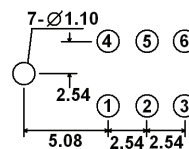
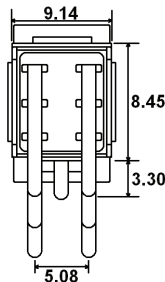
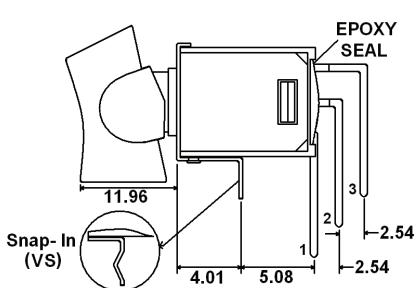
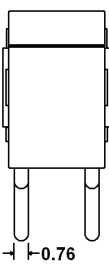

V (VS - Snap In) = Vertical mount, right angle PC pins, double pole

Terminal Options

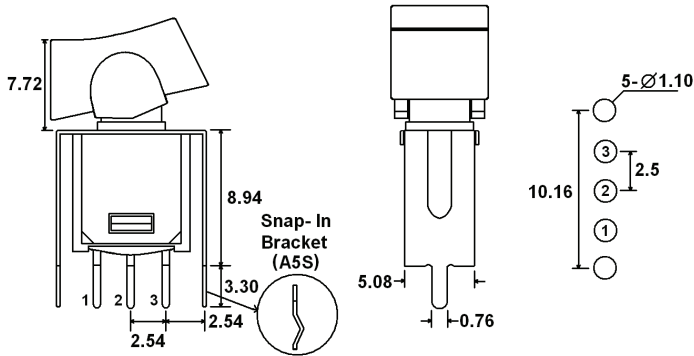

A5 (A5S - Snap In Bracket) = PC pins with support bracket, single pole

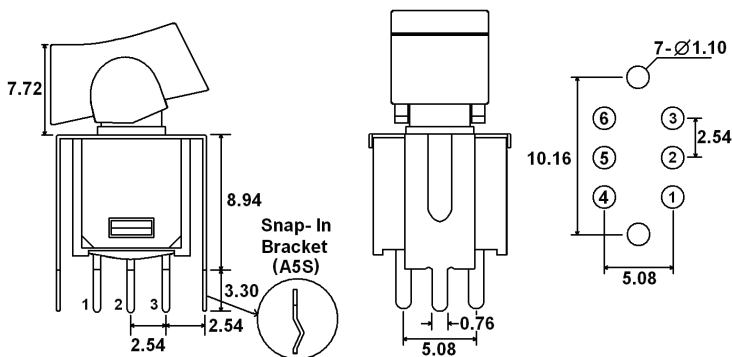

A5 (A5S - Snap In Bracket) = PC pins with support bracket, double pole

Contact Options

Designator	Contact Material	Terminal Material	Electrical Ratings
Q	Silver Plating	Silver Plating	3A @ 120VAC, 28VDC; 1A @ 250VAC
R	Gold over Nickel Plating	Gold over Nickel Plating	0.4VA max @ 20VAC or VDC max
G	Gold over Silver Plating	Gold over Silver Plating	0.4VA max @ 20VAC or VDC max or 3A @ 120VAC, 28VDC; 1A @ 250VAC