

Specifications

Electrical Ratings	200mA @ 30VDC	Actuation Force	200 ± 100gF
Electrical Life	10,000 cycles typical	Actuation Travel	2.0mm total
Contact Resistance	<50mΩ initial	Operating Temperature	-40°C to 85°C
Dielectric Strength	1000Vrms min	Storage Temperature	-40°C to 85°C
Insulation Resistance	>100MΩ min		

Materials

Actuator	6/6 Nylon
Housing	Steel
Base	Phenolic
Contacts	Phosphor Bronze, Silver Plated
Terminals	Brass, Silver Plated

Ordering Information

1. Series	MS1247	L4
	MS1247	
2. Actuator Length		
	L2 = 2mm	
	L4 = 4mm	
	L6 = 6mm	

Dimensions

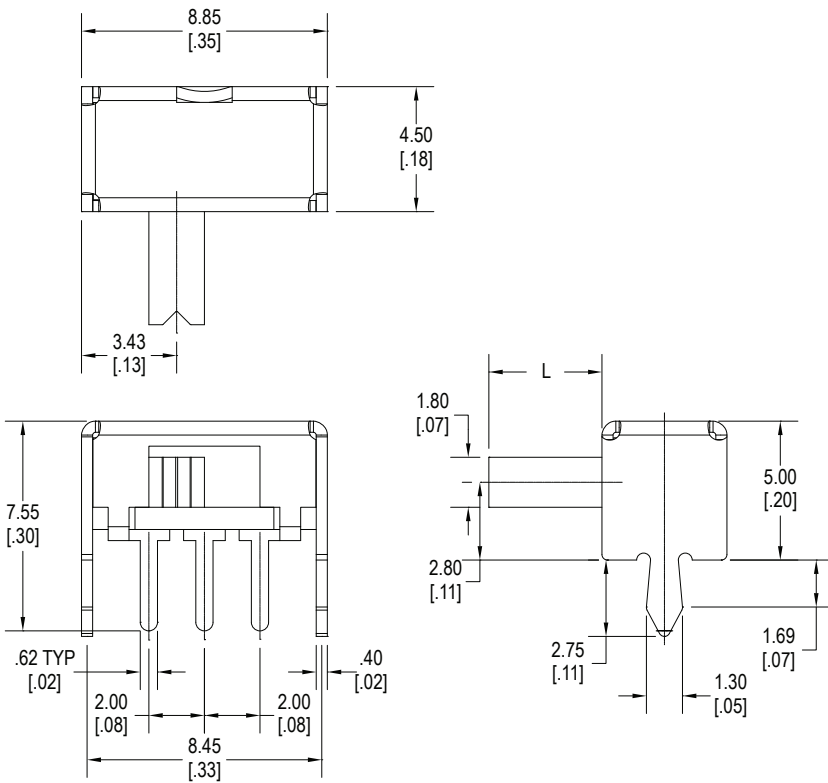

Schematic & PC Layout

