

Miniature Pushbutton

Specifications

Electrical Ratings	25mA @ 50VDC	Dielectric Strength	1500Vrms min
Electrical Life	1,000,000 cycles typical	Insulation Resistance	>100MΩ min
Contact Resistance	<25mΩ initial	Operating Temperature	-40°C to 85°C
Actuation Force	150 ± 50gF	Storage Temperature	-40°C to 85°C

Materials

Cap	ABS
Housing	6/6 Nylon
Contacts	Copper Alloy, Gold over Nickel Plated
Terminals	Copper Alloy, Silver Plated

Ordering Information

1. Series	NC	A	3
NC			
2. Cover Style			
A			
B			
C			
D			
E			
F			
3. Cover Color			
1 = White	6 = Orange		
2 = Black	7 = Blue		
3 = Red	8 = Dark Gray		
4 = Yellow	9 = Light Gray		
5 = Green			
4. Caps		Cap Colors	
Blank = No Cap	C16		
C11	C17*	** See cap options for color availability	
C12	C18	** Caps available with C & E actuators only	
C13	C19	* C15 & C17 fit only E Actuator	
C14	C22		
C15*	C26		

Dimensions

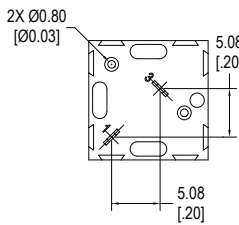
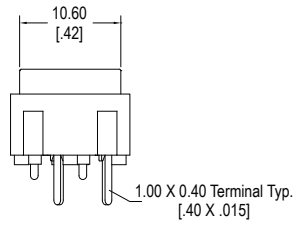
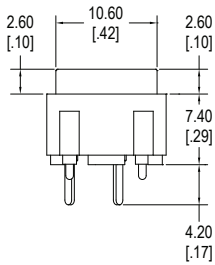
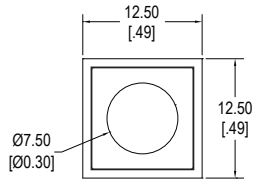

A Style Cover

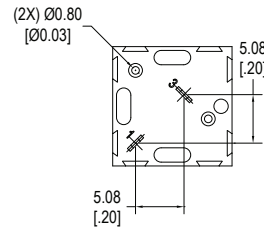
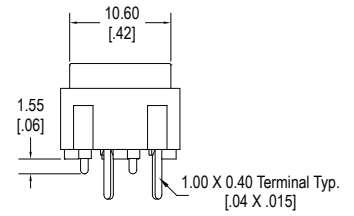
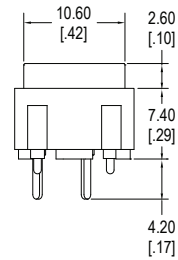
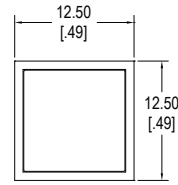

B Style Cover

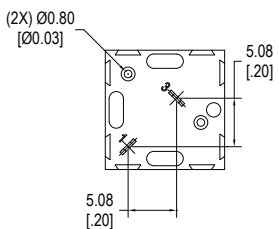
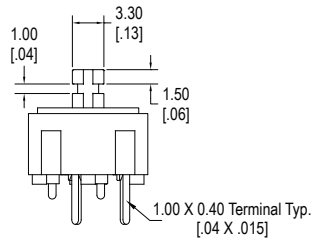
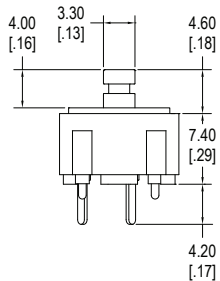
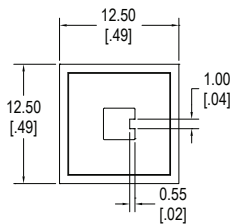

C Style Cover

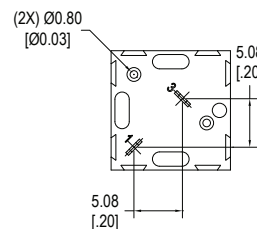
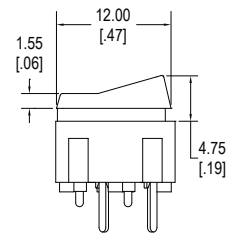
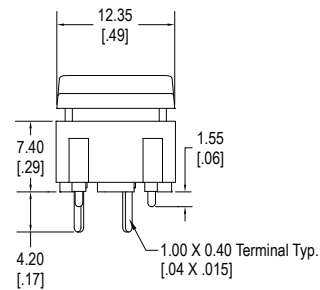
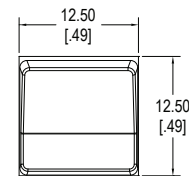

D Style Cover

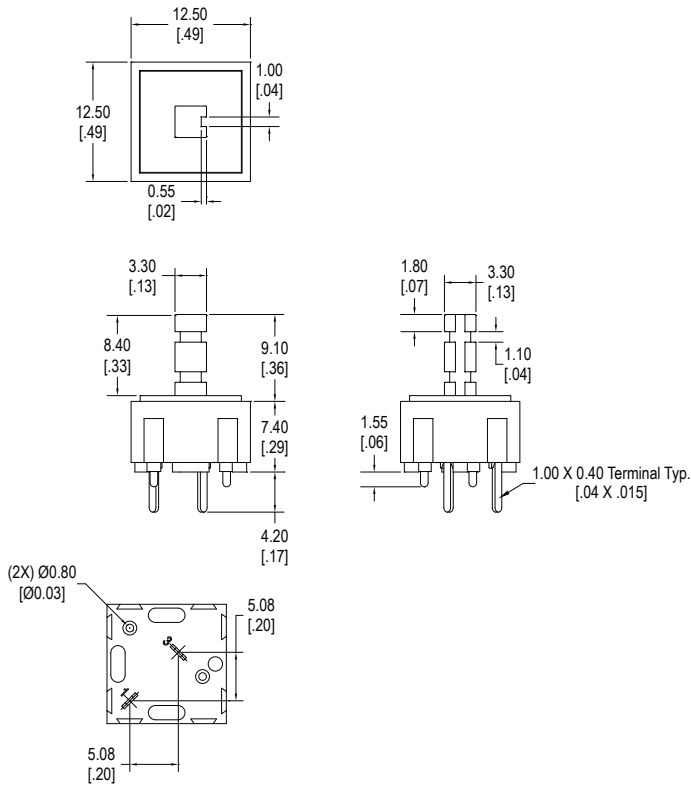

E Style

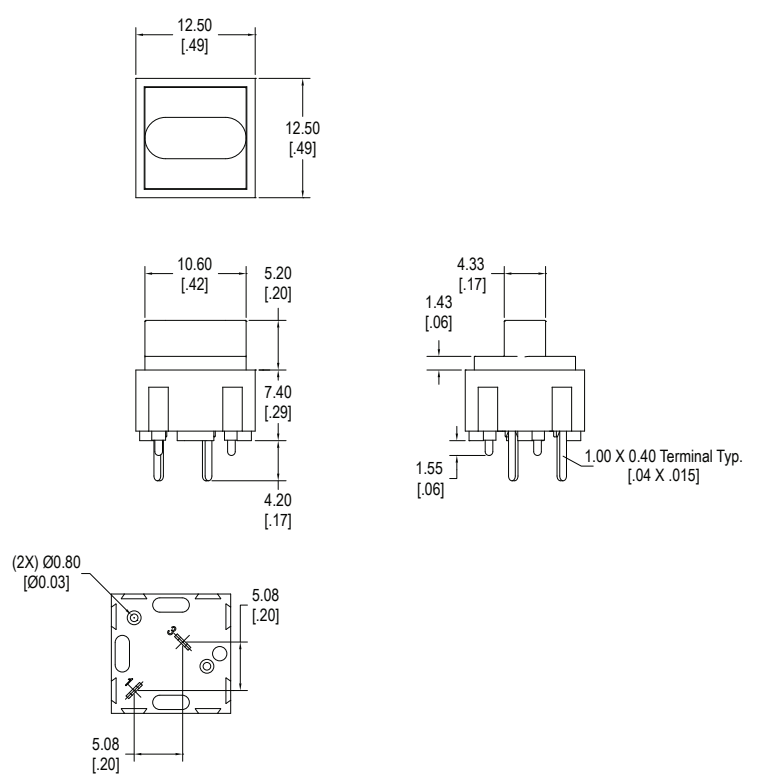

F Style

Schematic & PC Layout

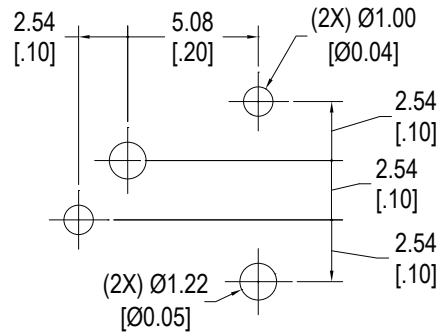
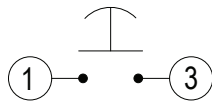

Cap Options for C & E Cover Styles

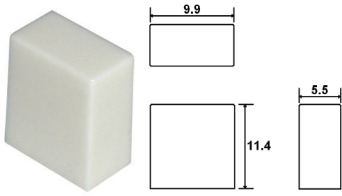

C11_

1 = White, 2 = Black, 3 = Red, 9 = Light Gray
Contact Factory for other available colors

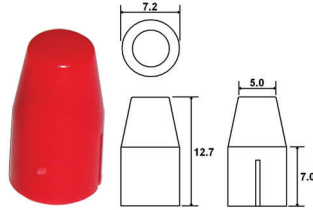

C12_

1 = White, 2 = Black, 3 = Red, 9 = Light Gray
Contact Factory for other available colors

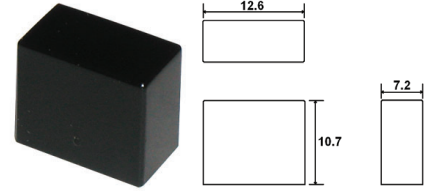

C13_

1 = White, 2 = Black, 3 = Red, 9 = Light Gray
Contact Factory for other available colors

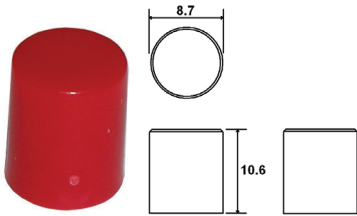

C14_

1 = White, 2 = Black, 3 = Red, 9 = Light Gray
Contact Factory for other available colors

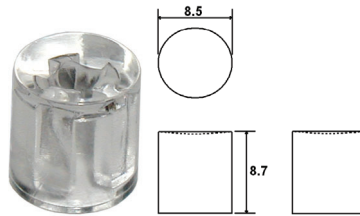

C15_

2 = Black, 0 = Clear
Contact Factory for other available colors

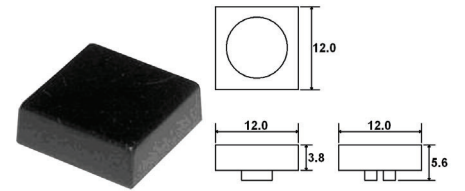

C16_

1 = White, 2 = Black, 3 = Red, 7 = Blue
Contact Factory for other available colors

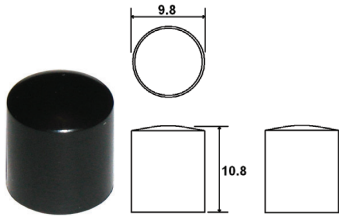

C17_

2 = Black, 0 = Clear
Contact Factory for other available colors

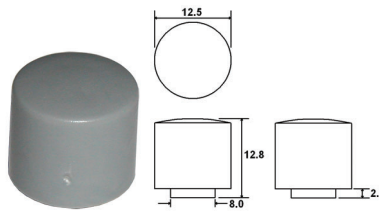

C18_

1 = White, 2 = Black, 9 = Light Gray
Contact Factory for other available colors

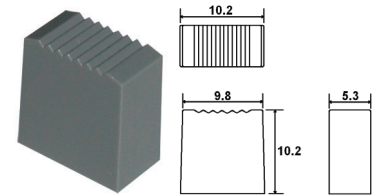

C19_

1 = White, 2 = Black, 3 = Red, 8 = Dark Gray
Contact Factory for other available colors

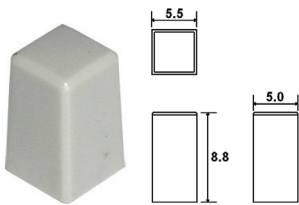

C22_

2 = Black, 8 = Dark Gray, 9 = Light Gray
Contact Factory for other available colors

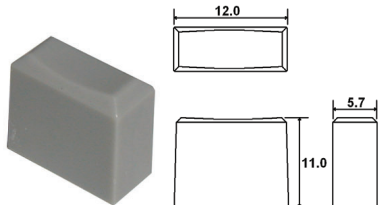

C26_

1 = White, 2 = Black, 3 = Red, 9 = Light Gray
Contact Factory for other available colors