

Neon / LED Illuminated Round Rocker

- *Wide variety of applications from industrial to consumer products*
- *Single pole single throw with neon lamp and LED options*
- *Quick connect termination*
- *Full or dot illumination*
- *Numerous choices in illumination colors and markings*

Specifications

Switch Function	SPST	Contact Resistance	≤ 50mΩ initial
Electrical Ratings	UL 61058-1	Dielectric Strength	1500Vrms min
	15A @ 125VAC General Purpose 10A @ 250VAC General Purpose	Insulation Resistance	≥ 100MΩ min
Electrical Life	10,000 cycles typical	Operating Temperature	-20°C to 70°C
		Storage Temperature	-20°C to 70°C
		Sealing Degree	IP40

Materials

Base	6/6 Nylon
Housing	6/6 Nylon
Actuator	6/6 Nylon or Polycarbonate
Actuator Lens	Polycarbonate (PC)
Contacts	Silver Alloy
Terminals	Brass, Silver Plated

Ordering Information

1. Series	RR3	1	1	2	23T	FB	C	N17
RR3								
2. Number of Poles								
1 = Single Pole								
3. Switch Function								
1 = OFF - ON								
4. Housing Color								
1 = White								
2 = Black								
9 = Gray								
5a. Solid Actuator Color with Lens	— Requires lens color choice below							
1 = White	4 = Yellow	7 = Blue						
2 = Black	5 = Green	8 = Purple						
3 = Red	6 = Orange	9 = Gray						
Lens Color								
0T = Clear (Transparent)	5T = Green (Transparent)							
3T = Red (Transparent)	7T = Blue (Transparent)							
4T = Yellow (Transparent)								
5b. Transparent Actuator Color:								
1T = White	5T = Green							
3T = Red	6T = Orange							
4T = Yellow	7T = Blue							
6. Actuator Marking	— Requires marking color choice below							
A	E							
B	F							
C	G							
D	K							
Actuator Marking Color								
Blank = No Marking								
B = Black								
W = White								
R = Red								
7. Terminal Option								
C = .187" Quick Connect / Solder Lug								
8a. Lamp Options*								
N1 = 125VAC Neon Lamp								
N2 = 250VAC Neon Lamp								
*Requires lamp color choice below								
Neon Lamp Colors								
0 = standard lamp								
5 = Green								
7 = Blue								
8b. LED Options**								
R12 = Red LED 12V	B12 = Blue LED 12V							
R24 = Red LED 24V	B24 = Blue LED 24V							
Y12 = Yellow LED 12V	W12 = White LED 12V							
Y24 = Yellow LED 24V	W24 = White LED 24V							
G12 = Green LED 12V								
G24 = Green LED 24V								
**only available with fully transparent actuators (Section 5b)								

Dimensions

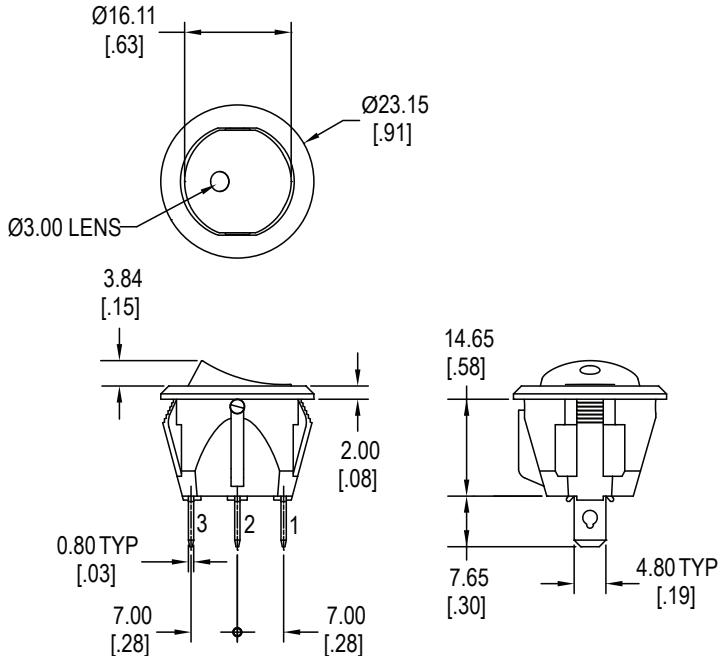

Solid Actuator with Lens

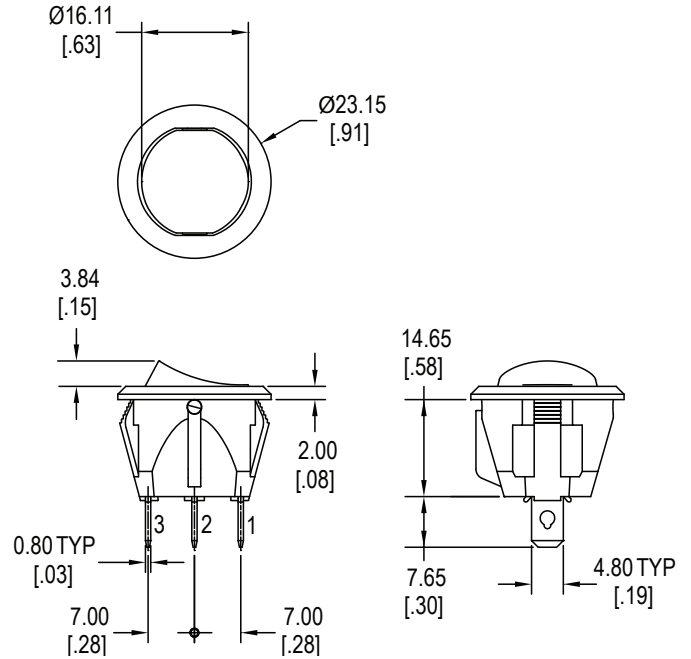

Transparent Actuator

Function	Position 1	Position 2
1	OFF	ON
Terminals	--	1 ~ 2

Actuator Marking Options

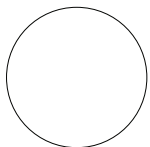

A

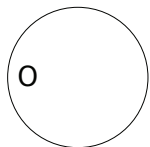

B

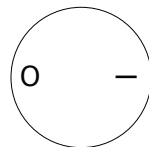

C

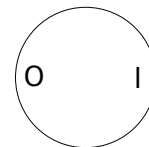

D

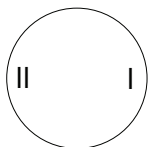

E

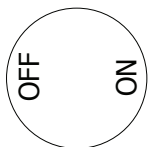

F

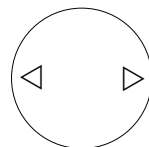

G

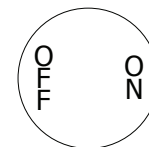

K

Schematics

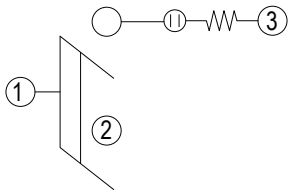

Neon

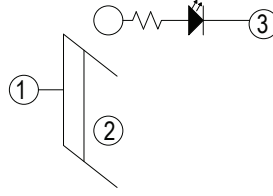

LED with Resistor

LED Characteristics

LED Ratings		Color					Units
		R	Y	G	B	W	
Reverse Voltage	V_R	5	5	5	5	5	V
Forward Current (avg)	I_F	30	30	30	30	30	mA
Reverse Current $V_R = 5V$	I_R	10	10	10	10	10	μA
Power Dissipation	P_T	56	56	46	72	76	mW
Operating & Storage Temperature	T_A	-40 ~ +85					C°
Forward Voltage (min) $I_F = 20mA$	V_F	1.7	1.7	1.8	2.8	2.8	V
Forward Voltage (max) $I_F = 20mA$	V_F	2.4	2.4	2.4	3.4	3.4	V
Wavelength (min) $I_F = 20mA$	λ_d	620	585	565	460	n/a	nm
Wavelength (max) $I_F = 20mA$	λ_d	630	595	575	470	n/a	nm
Luminous Intensity, $I_F = 20mA$	LI	50	150	30	140	500	mcd
Viewing Angle	Θ	50	50	70	120	70	deg

Panel Cut Out

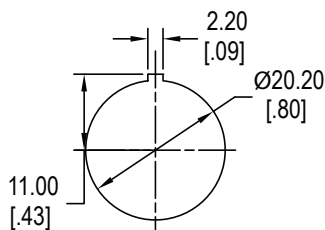

Panel cut out material thickness : 0.8mm ~ 3.0mm

Terminal Options

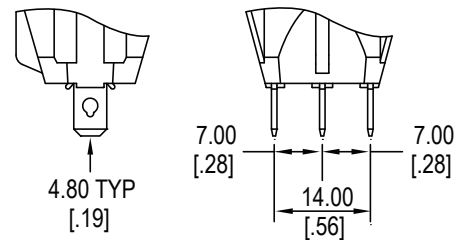

C