

E222871

Snap Action

Specifications

UL Electrical Ratings	Evaluated to UL 1054 5A @ 125VAC / 250VAC; resistive, T120, 6K cycles	Actuation Forces	80gF, 130gF, 350gF
Electrical Life	100,000 cycles typical	Dielectric Strength	1000Vrms min @ sea level
Mechanical Life	10,000,000 cycles typical	Insulation Resistance	≥100MΩ min.
Contact Resistance	<20mΩ initial	Operating Temperature	-40°C to +120°C
		Storage Temperature	-40°C to +120°C

Materials

Base / Cover	Polybutylene Terephthalate (PBT), UL94-V0
Pin Plunger	Polybutylene Terephthalate (PBT), UL94-V0
Contacts	Silver Alloy
Terminals	Copper Alloy, Silver Plated

Ordering Information

1. Series	SM3	A	Q	F130	1	L00
SM3						
2. Circuit	A = SPST N.O. B = SPST N.C. C = SPDT					
3. Contact Material	Q = Silver					
4. Operating Force without lever **Contact factory for other force options	F080 = 80gF F130 = 130gF F350 = 350gF					
5. Termination	1 = .110" Quick Connect 2 = Solder Lug 3 = PC Terminal 4 = Right Angle PC Terminal 5 = Left Angle PC Terminal					
6. Actuator (Lever)	L00 = Pin plunger L01 = Hinge lever, standard L02 = Simulated roller L03 - Roller lever, short L04 = Hinge lever, long					

Dimensions

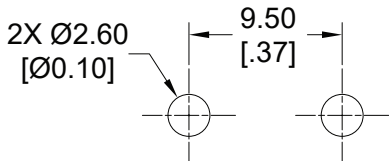
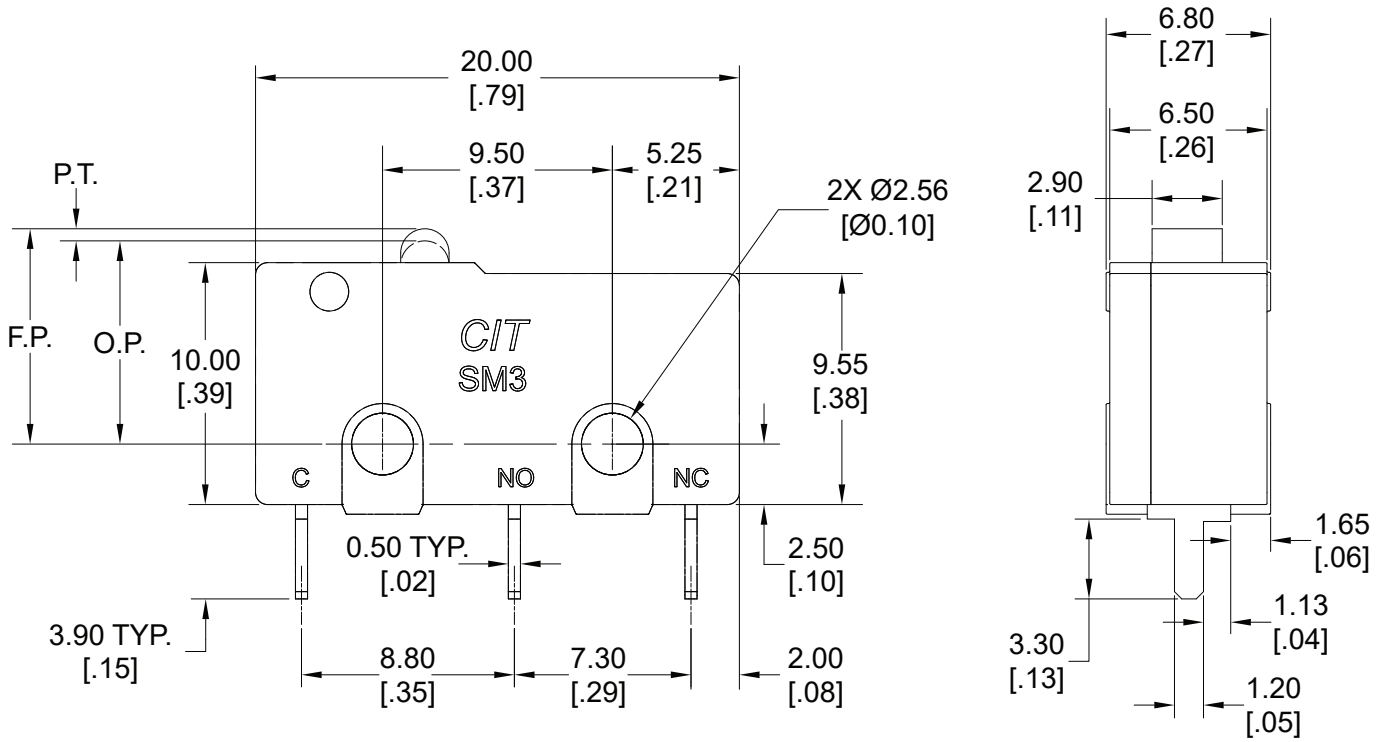

Panel Mounting

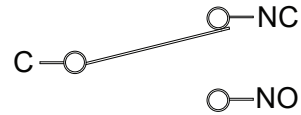

Schematic

Switch Characteristics

Actuators (Levers)	Operating Force - OF (grams)			Release Force - RF (grams)			Free Position (FP) all forces max (mm)	Pre-Travel (PT) all forces max (mm)	Operating Position (OP) all forces (mm)	Over Travel (OT) (mm)	*Movement Differential (MD) all forces max (mm)
	80gF	130gF	350gF	80gF	130gF	350gF					
L00	80+20/-30	130±30	350+30/-100	30~80	60~130	150~320	9.2	0.9	8.3±0.3	0.5	0.4
L01	20±10	30±15	80±30	5 min	10~30	25~75	12.2	3.0	9.6±0.8	1.0	1.0
L02	20±10	30±15	80±30	5 min	10~35	25~75	15.1	3.5	11.85±1.2	1.2	1.0
L03	18±8	30±15	70±25	5 min	10~35	30~80	19.15	3.0	14.4±1.0	1.0	0.8
L04	12±5	15±8	45±25	5 max	5~25	20~50	15.8	3.8	12 min	1.8	2.0

*Movement Differential (MD) : Distance or angle from the operating position to the release position.

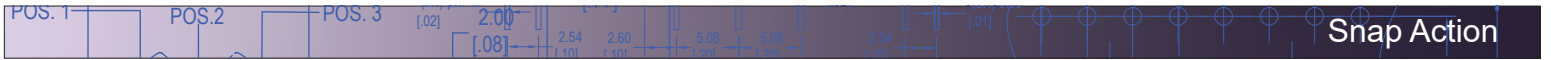

Terminal Options

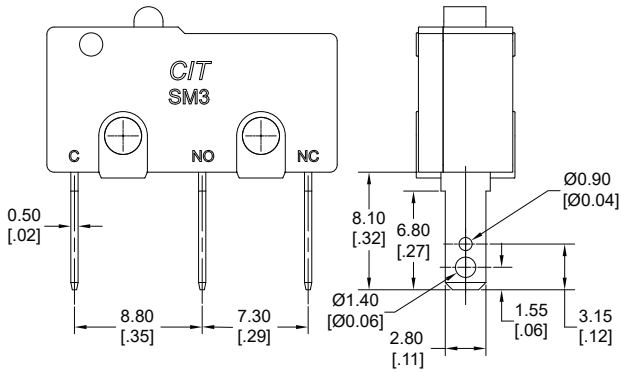

.110" Quick Connect Terminals

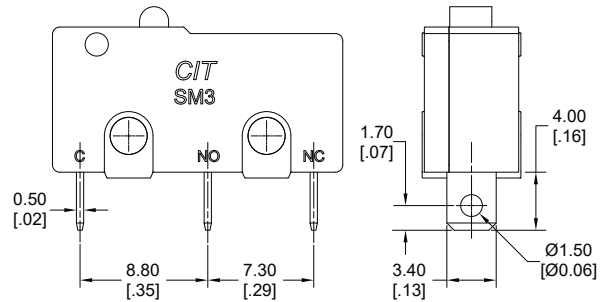

Solder Lug

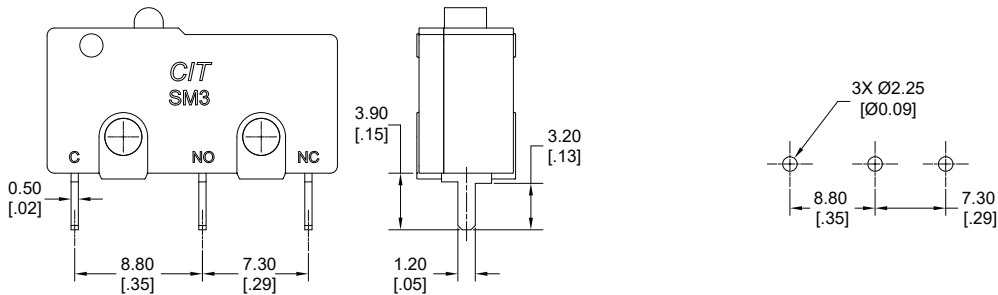

PC Terminals

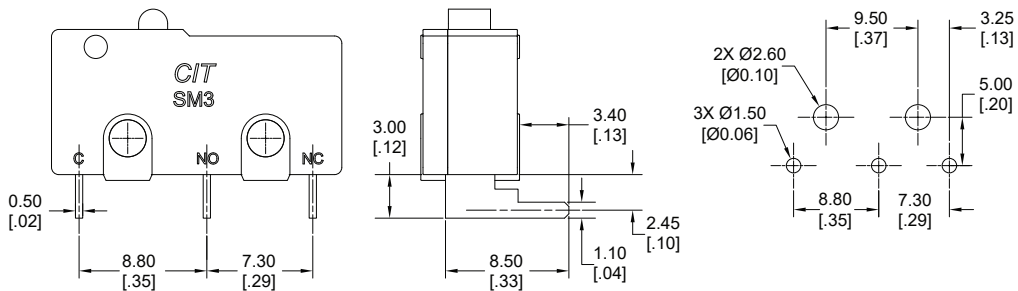

Right Angle PC Terminals

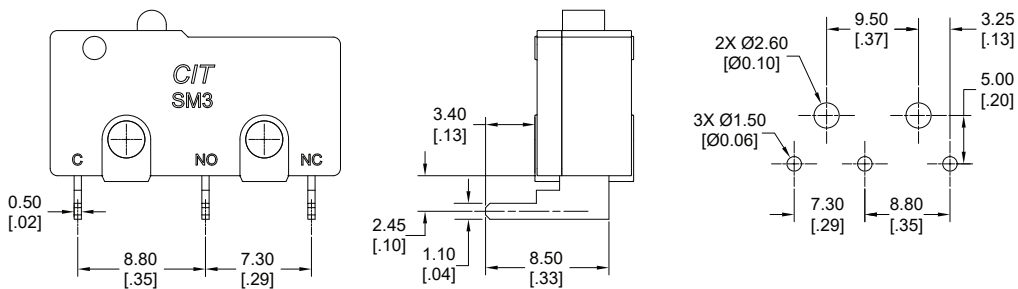

Left Angle PC Terminals

Levers

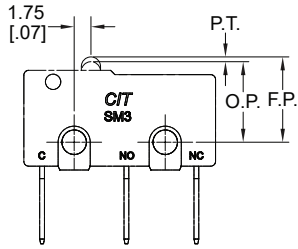
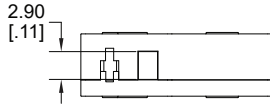

L00

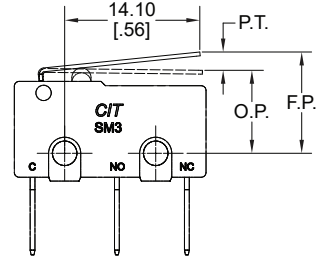

L01

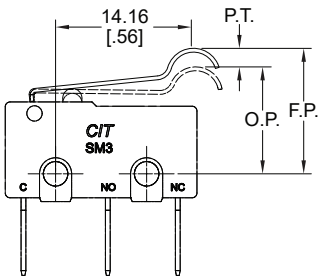

L02

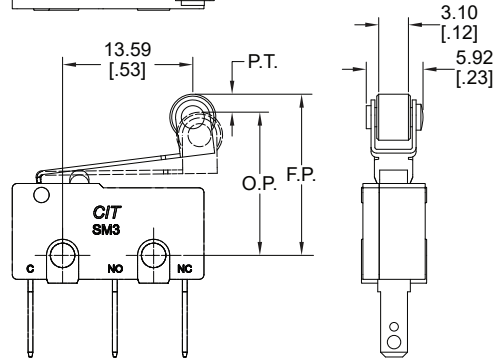
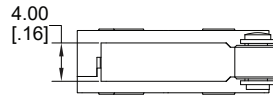

L03

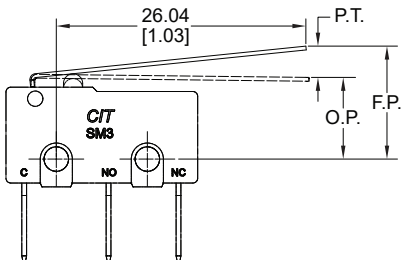

L04