

# Product data sheet

Specifications



power plug in relay, Harmony Electromechanical Relays, 15A, 4CO, with LED, with lockable test button, 24V AC

RPM42B7

## Main

Range of product	Harmony Electromechanical Relays
Series name	RPM series
Product or component type	Plug-in relay
Contacts type and composition	4 C/O
Relay type	Power relay
status LED	With
[Uc] control circuit voltage	24 V AC 50/60 Hz
Minimum switching capacity	170 mW at 10 mA, 17 V
Release time	20 ms at nominal voltage
Ambient air temperature for operation	-40...55 °C
[Ithe] conventional enclosed thermal current	15 A at -40...55 °C

## Complementary

Control type	Lockable test button
[Ie] rated operational current	15 A at 277 V (AC) conforming to UL 15 A at 28 V (DC) conforming to UL 15 A at 250 V (AC) NO conforming to IEC 15 A at 28 V (DC) NO conforming to IEC 7.5 A at 250 V (AC) NC conforming to IEC 7.5 A at 28 V (DC) NC conforming to IEC
Degree of protection (Housing only)	IP40 conforming to IEC 60529
Rated operational voltage limits	19.2...26.4 V AC
[Ui] rated insulation voltage	250 V conforming to IEC 300 V conforming to CSA 300 V conforming to UL
Maximum switching voltage	250 V conforming to IEC
Drop-out voltage threshold	$\geq 0.15 U_c$ AC
Maximum switching capacity	3750 VA 420 W
Mechanical durability	10000000 cycles
Electrical durability	100000 cycles for resistive load
Safety reliability data	B10d = 100000
Operating rate	$\leq 1200$ cycles/hour under load $\leq 18000$ cycles/hour no-load
Utilisation coefficient	20 %

<b>Dielectric strength</b>	1500 V AC between contacts with micro disconnection 2000 V AC between coil and contact with reinforced 2000 V AC between poles with basic
<b>[Uimp] rated impulse withstand voltage</b>	4 kV during 1.2/50 µs
<b>Protection category</b>	RT I
<b>Mounting support</b>	Plug-in
<b>Operating position</b>	Any position
<b>Test levels</b>	Level A group mounting
<b>Device presentation</b>	Complete product
<b>Contacts material</b>	AgNi
<b>Shape of pin</b>	Flat (faston type)
<b>Product weight</b>	0.071 kg

## Environment

<b>Average coil consumption in VA</b>	2.5 at 60 Hz
<b>Pollution degree</b>	3
<b>Standards</b>	IEC 61810-1 CSA C22.2 No 14 UL 508
<b>Product certifications</b>	CSA EAC UL
<b>Ambient air temperature for storage</b>	-40...85 °C
<b>Vibration resistance</b>	3 gn, amplitude = +/- 1 mm (f = 10...150 Hz)5 cycles in operation 5 gn, amplitude = +/- 1 mm (f = 10...150 Hz)5 cycles not operating
<b>Shock resistance</b>	15 gn for in operation 30 gn for not operating

## Packing Units

<b>Unit Type of Package 1</b>	PCE
<b>Number of Units in Package 1</b>	1
<b>Package 1 Height</b>	2.500 cm
<b>Package 1 Width</b>	4.000 cm
<b>Package 1 Length</b>	4.500 cm
<b>Package 1 Weight</b>	71.000 g
<b>Unit Type of Package 2</b>	BB1
<b>Number of Units in Package 2</b>	10
<b>Package 2 Height</b>	3.000 cm
<b>Package 2 Width</b>	10.000 cm
<b>Package 2 Length</b>	22.500 cm
<b>Package 2 Weight</b>	757.000 g
<b>Unit Type of Package 3</b>	S02
<b>Number of Units in Package 3</b>	120
<b>Package 3 Height</b>	15.000 cm
<b>Package 3 Width</b>	30.000 cm

---

Package 3 Length	40.000 cm
------------------	-----------

---

Package 3 Weight	9.328 kg
------------------	----------

## Contractual warranty

---

Warranty	18 months
----------	-----------



## Environmental Data

Schneider Electric aims to achieve Net Zero status by 2050 through supply chain partnerships, lower impact materials, and circularity via our ongoing “Use Better, Use Longer, Use Again” campaign to extend product lifetimes and recyclability.

[Environmental Data explained >](#)

[How we assess product sustainability >](#)

### Environmental footprint

Total lifecycle Carbon footprint	34
----------------------------------	----

## Use Better

### Materials and Substances

Packaging made with recycled cardboard	Yes
--	-----

Packaging without single use plastic	Yes
--------------------------------------	-----

[EU RoHS Directive](#)

Pro-active compliance (Product out of EU RoHS legal scope)

California proposition 65

**WARNING:** This product can expose you to chemicals including: Nickel compounds, which is known to the State of California to cause cancer, and Di-isodecyl phthalate (DIDP), which is known to the State of California to cause birth defects or other reproductive harm. For more information go to [www.P65Warnings.ca.gov](http://www.P65Warnings.ca.gov)

## Use Again

### Repack and remanufacture

End of life manual availability	No need of specific recycling operations
---------------------------------	--

Take-back	No
-----------	----

Dimensions Drawings

Dimensions

---

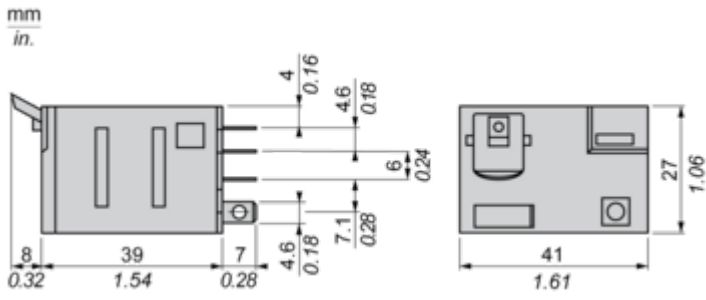

Pin Side View

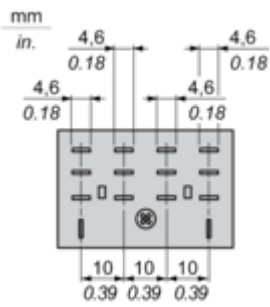

Connections and Schema

Wiring Diagram

---

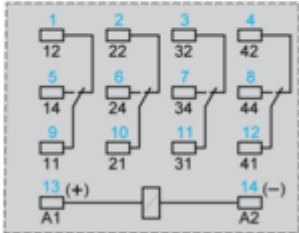
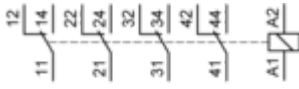

Symbols shown in blue correspond to Nema marking.

Performance Curves

**Electrical Durability of Contacts**

---

**Durability (inductive load) = durability (resistive load) x reduction coefficient.**  
 Resistive AC load

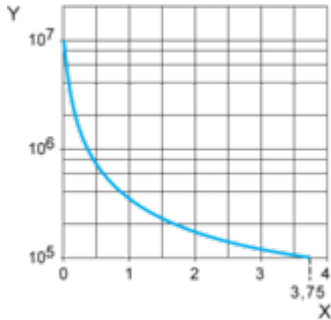

X Switching capacity (kVA)

Y Durability (Number of operating cycles)

Reduction coefficient for inductive AC load (depending on power factor cos φ)

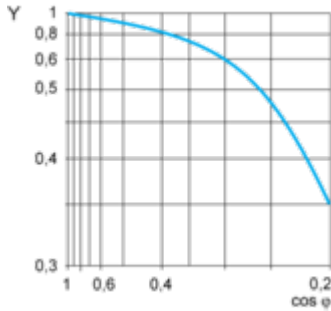

Y Reduction coefficient (A)

Maximum switching capacity on resistive DC load

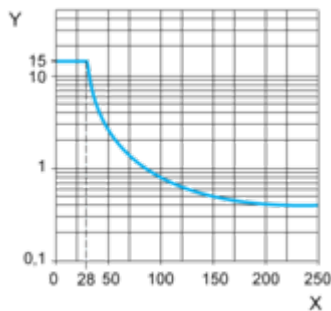

X Voltage DC

Y Current DC

**Note :** These are typical curves, actual durability depends on load, environment, duty cycle, etc.

Technical Illustration

Dimensions

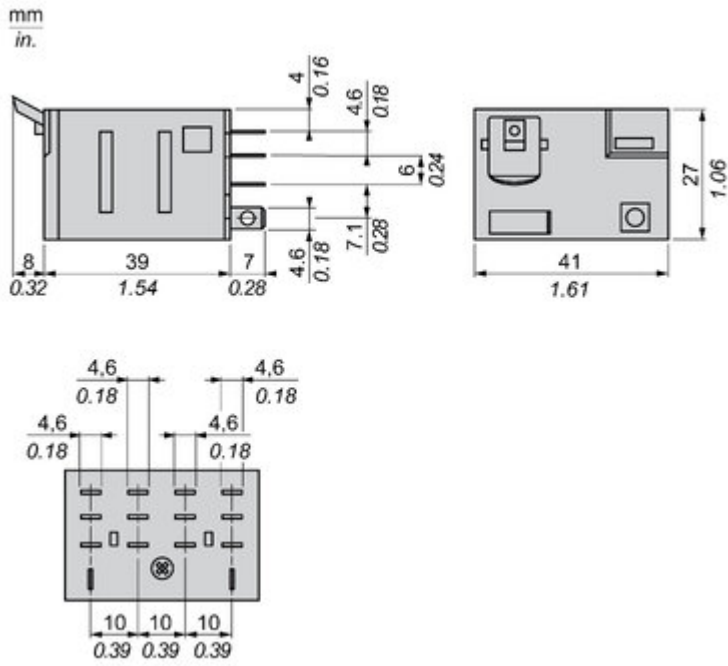

Image of product / Alternate images

Alternative

---

