

Product data sheet

Specifications



interface plug in relay, Harmony Electromechanical Relays, 16A, 1C/O, without LED, without lockable test button, 24V DC

RSB1A160BD

Main

Range of product	Harmony Electromechanical Relays
Series name	RSB series
Product or component type	Plug-in relay
Relay type	Interface relay
Contacts type and composition	1 C/O
status LED	Without
[Uc] control circuit voltage	24 V DC
Control type	Without lockable test button
[Ithe] conventional enclosed thermal current	16 A at -40...40 °C

Complementary

Average resistance	1440 Ohm network: AC at 20 °C +/- 10 %
[Ue] rated operational voltage	16.8...36 V DC
[Uimp] rated impulse withstand voltage	3.6 kV conforming to IEC 61000-4-5
[Ie] rated operational current	16 A (AC-1/DC-1) NO conforming to IEC 8 A (AC-1/DC-1) NC conforming to IEC
[Ui] rated insulation voltage	400 V conforming to IEC 60947
Maximum switching voltage	300 V DC conforming to IEC
Drop-out voltage threshold	$\geq 0.1 U_c$ DC
Load current	16 A at 250 V AC 16 A at 28 V DC
minimum switching current	10 mA
Maximum switching capacity	4000 VA/448 W
minimum switching voltage	12 V
Minimum switching capacity	120 mW at 10 mA, 12 V
Operating time	20 ms operating 20 ms reset
Mechanical durability	30000000 cycles
Electrical durability	100000 cycles, 16 A at 250 V, AC-1 NO 100000 cycles, 8 A at 250 V, AC-1 NC
Safety reliability data	B10d = 100000
Operating rate	≤ 600 cycles/hour under load ≤ 18000 cycles/hour no-load

Average coil consumption	0.45 W DC
Removable legend	Without
Protection category	RT I
Operating position	Any position
Test levels	Level A group mounting
Device presentation	Complete product
Sale per indivisible quantity	10
Contacts material	Silver alloy (AgNi)
Shape of pin	Flat (PCB type)
Product weight	0.014 kg
Compatibility code	RSB

Environment

Dielectric strength	1000 V AC between contacts 2500 V AC between poles 5000 V AC between coil and contact
Vibration resistance	+/- 1 mm (f= 10...55 Hz) conforming to IEC 60068-2-6
IP degree of protection	IP40 conforming to IEC 60529
Ambient air temperature for operation	-40...85 °C (DC)
Standards	UL 508 CSA C22.2 No 14 IEC 61810-1
Product certifications	EAC CSA UL
Marking	CE
Ambient air temperature for storage	-40...85 °C
Shock resistance	10 gn (duration = 11 ms) for not operating conforming to IEC 60068-2-27 5 gn (duration = 11 ms) for in operation conforming to IEC 60068-2-27

Packing Units

Unit Type of Package 1	PCE
Number of Units in Package 1	1
Package 1 Height	1.700 cm
Package 1 Width	2.500 cm
Package 1 Length	31.000 cm
Package 1 Weight	12.000 g
Unit Type of Package 2	BB1
Number of Units in Package 2	10
Package 2 Height	1.700 cm
Package 2 Width	2.500 cm
Package 2 Length	31.100 cm
Package 2 Weight	146.000 g
Unit Type of Package 3	S01

Number of Units in Package 3	350
Package 3 Height	15.000 cm
Package 3 Width	15.000 cm
Package 3 Length	40.000 cm
Package 3 Weight	5.200 kg

Contractual warranty

Warranty	18 months
-----------------	-----------

Environmental Data

Schneider Electric aims to achieve Net Zero status by 2050 through supply chain partnerships, lower impact materials, and circularity via our ongoing “Use Better, Use Longer, Use Again” campaign to extend product lifetimes and recyclability.

[Environmental Data explained >](#)

[How we assess product sustainability >](#)

Environmental footprint

Total lifecycle Carbon footprint 15

Environmental Disclosure [Product Environmental Profile](#)

Use Better

Materials and Substances

Packaging made with recycled cardboard Yes

Packaging without single use plastic No

[EU RoHS Directive](#) Pro-active compliance (Product out of EU RoHS legal scope)

California proposition 65 **WARNING: This product can expose you to chemicals including: Nickel compounds, which is known to the State of California to cause cancer, and Di-isodecyl phthalate (DIDP), which is known to the State of California to cause birth defects or other reproductive harm. For more information go to www.P65Warnings.ca.gov**

Use Again

Repack and remanufacture

Take-back No

Dimensions Drawings

Dimensions

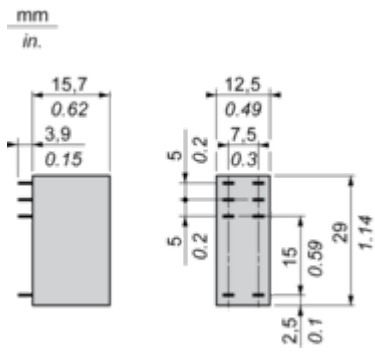

Connections and Schema

Wiring Diagram

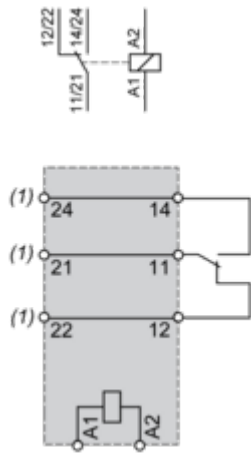

(1) Terminals 11 and 21,14 and 24,12 and 22 must be linked for this references

NOTE: For DC input, A1 have to be +, otherwise it would short circuit from protection module

Performance Curves

Electrical Durability of Contacts

Durability (inductive load) = durability (resistive load) x reduction coefficient.

Resistive AC load

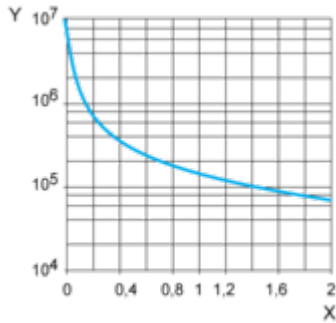

X Switching capacity (kVA)

Y Durability (Number of operating cycles)

Reduction coefficient for inductive AC load (depending on power factor cos φ)

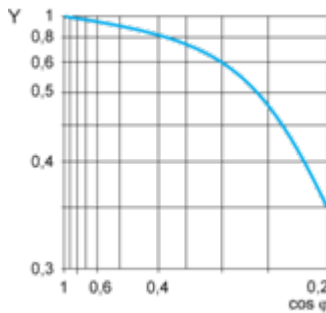

Y Reduction coefficient (A)

Maximum switching capacity on resistive DC load

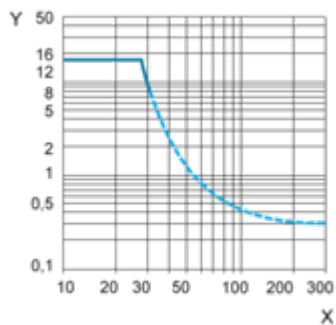

X Voltage DC

Y Current DC

Note : These are typical curves, actual durability depends on load, environment, duty cycle, etc.

Technical Illustration

Dimensions

mm
in.

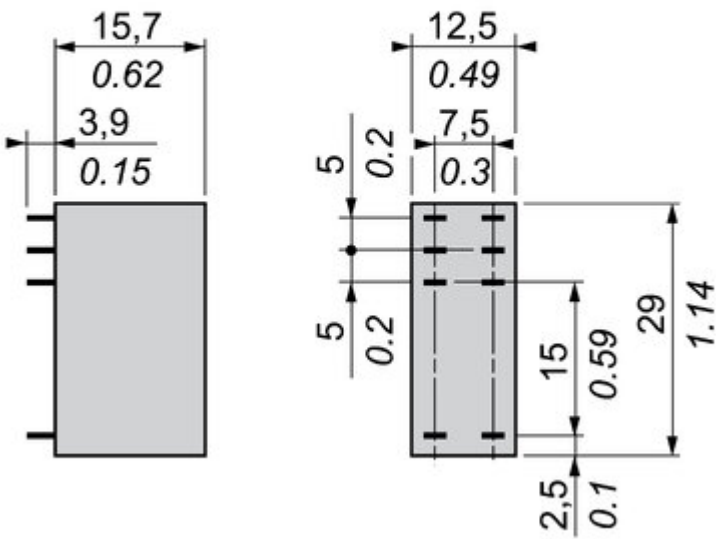

Image of product / Alternate images

Alternative



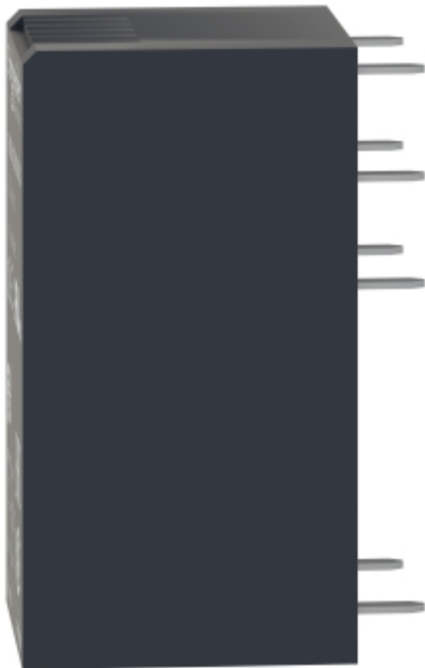
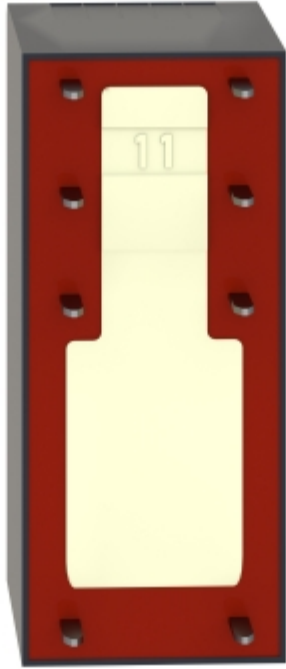

Image of product in real life situation

