

Product data sheet

Specifications



miniature, Harmony Electromechanical Relays, 5A, 2CO, with LED, 24V DC

RXM2LB2BD

Product availability: Non-Stock - Not normally stocked in distribution facility

Main

Range of Product	Harmony Electromechanical Relays
Series name	RXM series
Product or Component Type	Plug-in relay
Relay Type	Miniature relay
Contacts type and composition	2 C/O
[Uc] control circuit voltage	24 V DC
[Ithe] conventional enclosed thermal current	5 A -40...131 °F (-40...55 °C)

Complementary

Status LED	With
Control Type	Without lockable test button
[Ie] rated operational current	2.5 A 28 V DC) NC IEC 2.5 A 250 V AC) NC IEC 5 A 28 V DC) NO IEC 5 A 250 V AC) NO IEC 5 A 24 V DC) NO IEC 5 A 220 V AC) NO IEC 5 A 28 V DC) UL 5 A 250 V AC) UL
Minimum switching capacity	25 mW subject to switching frequency, environment or expected reliability level etc
Rated operational voltage limits	19.2...26.4 V DC
[Ui] rated insulation voltage	250 V IEC
Maximum switching voltage	250 V AC 28 V DC
Drop-out voltage threshold	$\geq 0.1 U_c$ DC
Load current	5 A 250 V AC 5 A 28 V DC
Maximum switching capacity	1250 VA AC 140 W DC
Minimum switching current	5 mA subject to switching frequency, environment or expected reliability level etc
Minimum switching voltage	5 V subject to switching frequency, environment or expected reliability level etc
Average resistance	640 Ohm at 73 °F (23 °C) +/- 10 %
Average coil consumption	0.9 W, DC
Mechanical durability	20000000 cycles
Electrical durability	200000 cycles resistive 23 °C 100000 cycles resistive at 55 °C

Price is "List Price" and may be subject to a trade discount – check with your local distributor or retailer for actual price.

Safety reliability data	B10d = 100000
Operating rate	<= 1200 cycles/hour under load <= 18000 cycles/hour no-load
Utilisation coefficient	20 %
Dielectric strength	2000 V AC between coil and contact with basic insulation 2000 V AC between poles with basic insulation 1000 V AC between contacts with micro disconnection
Protection category	RT I
Pollution degree	3
Operating position	Any position
Test levels	Level A group mounting
Sale per indivisible quantity	10
Contacts material	Silver alloy (Ag/Ni)
Shape of pin	Flat (faston type)
Net Weight	0.071 lb(US) (0.032 kg)

Environment

Standards	IEC 61810-1 (iss. 2) CE UL 508
Ambient Air Temperature for Storage	-40...185 °F (-40...85 °C)
Vibration resistance	3 gn +/- 1 mm 10...50 Hz)operating IEC 60068-2-6 6 gn +/- 1 mm 10...50 Hz)not operating IEC 60068-2-6
Shock resistance	30 gnot operating IEC 60068-2-27 10 gnin operation IEC 60068-2-27

Ordering and shipping details

Category	US1CP4B22153
Discount Schedule	CP4B
GTIN	3389119215275
Returnability	No
Country of origin	CN

Packing Units

Unit Type of Package 1	PCE
Nbr. of units in pkg.	1
Package 1 Height	0.787 in (2.000 cm)
Package 1 Width	0.984 in (2.500 cm)
Package 1 Length	1.772 in (4.500 cm)
Package weight(Lbs)	1.164 oz (33.000 g)
Unit Type of Package 2	BB1
Number of Units in Package 2	10
Package 2 Height	1.181 in (3.000 cm)
Package 2 Width	4.134 in (10.500 cm)
Package 2 Length	4.921 in (12.500 cm)

Package 2 Weight	12.804 oz (363.000 g)
Unit Type of Package 3	S02
Number of Units in Package 3	270
Package 3 Height	5.906 in (15.000 cm)
Package 3 Width	11.811 in (30.000 cm)
Package 3 Length	15.748 in (40.000 cm)
Package 3 Weight	22.190 lb(US) (10.065 kg)

Contractual warranty

Warranty (in months)	18
-----------------------------	----



Environmental Data

Schneider Electric aims to achieve Net Zero status by 2050 through supply chain partnerships, lower impact materials, and circularity via our ongoing “Use Better, Use Longer, Use Again” campaign to extend product lifetimes and recyclability.

[Environmental Data explained >](#)

[How we assess product sustainability >](#)

Environmental footprint

Carbon footprint (kg CO2 eq, Total Life cycle) 13

Environmental Disclosure [Product Environmental Profile](#)

Use Better

Materials and Substances

Packaging made with recycled cardboard Yes

Packaging without single use plastic Yes

[EU RoHS Directive](#) Pro-active compliance (Product out of EU RoHS legal scope)

REACH Regulation [REACH Declaration](#)

California proposition 65 **WARNING:** This product can expose you to chemicals including: Nickel compounds, which is known to the State of California to cause cancer, and Di-isodecyl phthalate (DIDP), which is known to the State of California to cause birth defects or other reproductive harm. For more information go to www.P65Warnings.ca.gov

Use Again

Repack and remanufacture

Circularity Profile [End of Life Information](#)

Take-back No

WEEE Label  The product must be disposed on European Union markets following specific waste collection and never end up in rubbish bins.

Dimensions Drawings

Dimensions

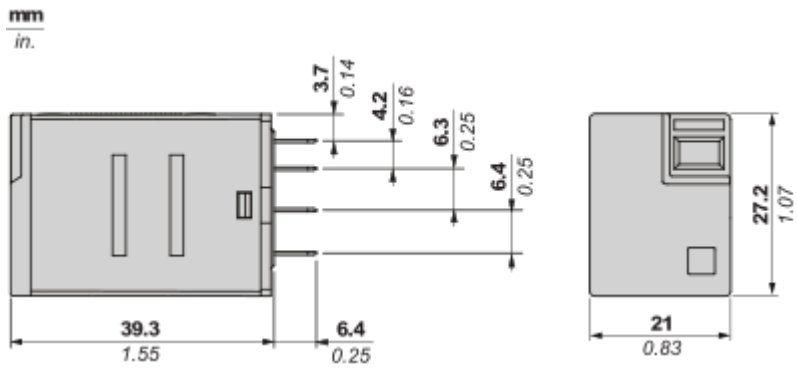

Pin Side View

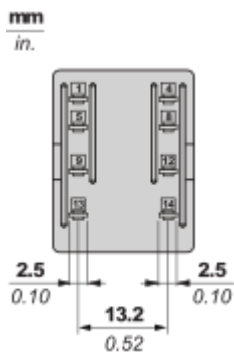

Connections and Schema

Wiring Diagram

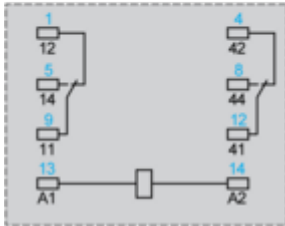
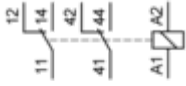

Symbols shown in blue correspond to Nema marking.

Performance Curves

Electrical Durability of Contacts

Durability (inductive load) = durability (resistive load) x reduction coefficient.

For 2 Poles Relay

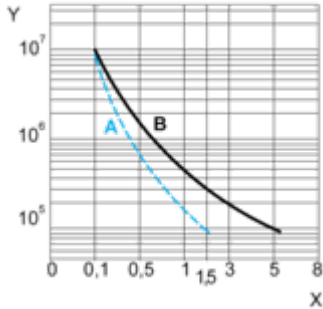

X : Contact current (A)

Y : Durability (Number of operating cycles)

A : Inductive load

B : Resistive load

Note : These are typical curves, actual durability depends on load, environment, duty cycle, etc.

For inductive load, to increase relay life cycles, please add a proper load protection circuit (eg: RC protection/Varistor/free Wheeling diode -DC load only-)

Maximum Switching Capacity

For 2 Poles Relay

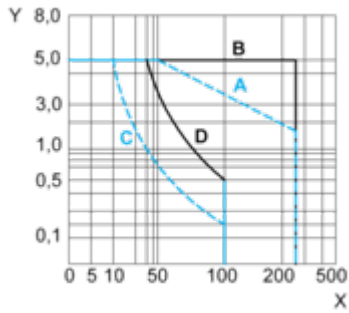

X : Contact voltage (v)

Y : Contact current (A)

A : Inductive AC load

B : Resistive AC load

C : Inductive DC load

D : Resistive DC load

Note : These are typical curves, actual durability depends on load, environment, duty cycle, etc.

For inductive load, to increase relay life cycles, please add a proper load protection circuit (eg: RC protection/Varistor/free Wheeling diode -DC load only-)

For low level loads (below 10mA), we recommend to use RXM*GB series with bifurcated contacts relays instead.

Technical Illustration

Dimensions

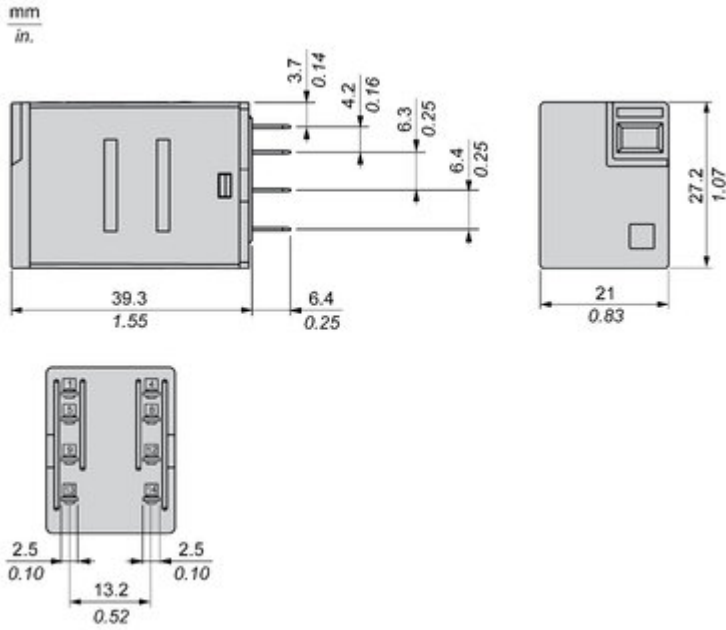

Offer Marketing Illustration

Product benefits / Features



Features
Easy Harmony RXMLB Relay

Fit to customer needs
coverage of most general control panel applications

Easy to select
simple selection and wide availability

Convenient to use
Easy status readiness through mechanical indicator & LED

Safe to perform
product reliability, compliance with industrial standard and eco-design

The image features a central photograph of a black RXMLB relay mounted on a terminal block. Surrounding this central image are four circular icons, each with a white background and a green symbol: a plug for 'Fit to customer needs', a magnifying glass for 'Easy to select', crossed wrench and screwdriver for 'Convenient to use', and a checkmark for 'Safe to perform'. The entire graphic is set against a solid green background.

Offer Marketing Illustration

Product benefits / Features

Technical Benefits

Easy Harmony RXMLB Relay

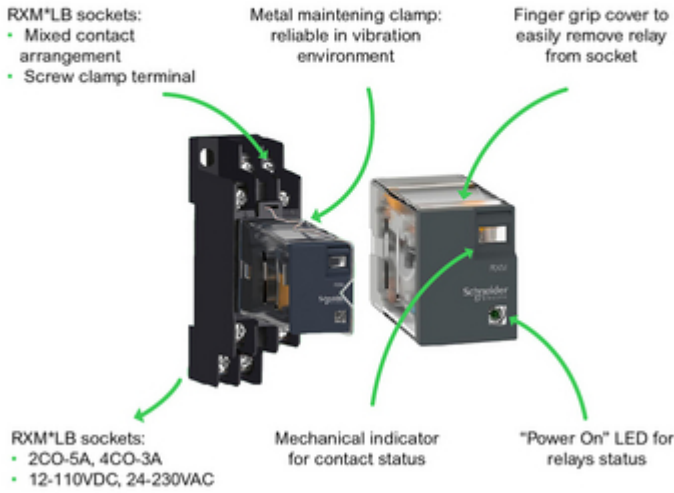

Image of product / Alternate images

Alternative



