



Better. By Design.

# CURRENT SENSING RELAYS

CATALOG OF PRODUCTS



# AC OVERCURRENT & UNDERCURRENT

## CAH, COH & CUH SERIES



- ◆ Monitors AC current
- ◆ Can be used as either an over-current or undercurrent relay
- ◆ Three separate adjustable Fault Trip Current ranges covering 0.5 – 50 amperes
- ◆ Built-in current transformer allows easy access & multiple loops for increased sensitivity
- ◆ Adjustable time delay on fault trip
- ◆ LED indicates fault condition
- ◆ 10A SPDT output contacts
- ◆ Encapsulated for protection in harsh environments
- ◆ Pilot Duty Rating



Better. By Design.

**800.238.7474**  
**WWW.MACROMATIC.COM**  
**SALES@MACROMATIC.COM**

The CxH Series is an AC current sensing relay that is available in three versions: **CAH Series**--can detect either an overcurrent or undercurrent fault (selectable); **COH Series**--overcurrent only; and **CUH Series**--undercurrent only. The current-carrying wire is run through the built-in current transformer and can be looped multiple times for greater sensitivity. These relays include user-adjustable settings for Fault Trip Current & Time Delay on Fault Trip as well as an LED to indicate fault condition. The encapsulated construction offers protection in harsh environments. Applications such as monitoring for locked rotor or load loss condition, open heater or lamp, and process control are perfect for these products.

### Overcurrent Sensing

After input voltage is applied & the sensing delay on power-up ( $t_s$ ) is completed, the unit will begin sensing for a fault condition. A fault will occur when the monitored AC current ( $I$ ) goes above the Fault Trip Current setting & remains above the Reset level for a period longer than the adjustable time delay period ( $t$ ). The LED will turn ON immediately and the relay will energize after the time delay on pick-up ( $t$ ) is completed. The relay will de-energize & the LED will turn OFF when the monitored AC current goes below the Reset level.

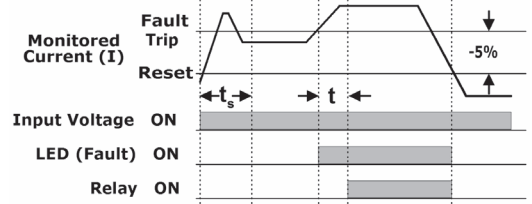

### Undercurrent Sensing

After input voltage is applied & the sensing delay on power-up ( $t_s$ ) is completed, the unit will begin sensing for a fault condition. A fault will occur when the monitored AC current ( $I$ ) goes below the Fault Trip Current setting & remains below the Reset level for a period longer than the adjustable time delay period ( $t$ ). The LED will turn ON immediately and the relay will energize after the time delay on pick-up ( $t$ ) is completed. The relay will de-energize & the LED will turn OFF when the monitored AC current goes above the Reset level.

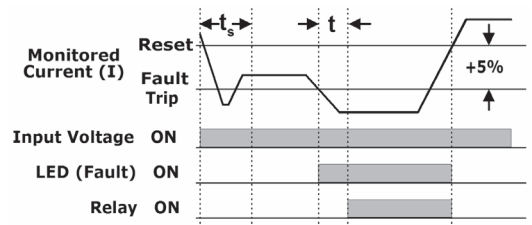

### CATALOG NUMBER

Complete by selecting proper code for each option below:

XXX XXX X X X

<b>FUNCTION</b> <b>CAH</b> Over & Under Current <b>COH</b> Overcurrent Only <b>CUH</b> Undercurrent Only	<b>FAULT TRIP CURRENT (I)</b> <b>05A</b> 0.5 - 5A <b>20A</b> 2 - 20A <b>50A</b> 5 - 50A	<b>INPUT VOLTAGE</b> <b>2</b> 120VAC <b>6</b> 12VDC <b>8</b> 24VAC/DC <b>1</b> 240VAC	<b>TRIP DELAY (t)</b> <b>A</b> 0.150 - 7 Sec. <b>B</b> 0.5 - 50 Sec. <b>Fixed Times</b> <b>F</b> followed by time delay in seconds, i.e., F0.5, F3, etc.	<b>SENSING DELAY ON POWER-UP (<math>t_s</math>)</b> <b>C</b> No Delay <b>D</b> 1 Second <b>E</b> 2 Seconds <b>F</b> 3 Seconds <b>G</b> 4 Seconds <b>H</b> 5 Seconds <b>J</b> 6 Seconds
---	--	---	--	---

Example: CAH20A2BD, COH05A8AC, CAH20A2F1E

CURRENT SENSING RELAYS | ENCAPSULATED

# AC OVERCURRENT & UNDERCURRENT

## CAH, COH & CUH SERIES

### APPLICATION DATA

#### Input Voltage Tolerance:

AC Operation: +10/-15% of nominal at 50/60 Hz.  
DC Operation: +10/-15% of nominal

**Load (Burden):** 2VA for all voltages

#### Current Sensing:

Ranges: Separate 0.5-5A, 2-20A & 5-50A

Type: Toroidal, through hole wiring

Setting Accuracy: Min: +0%, -50%; Max: +10%, -0%

Maximum Allowable Current:

0.5-5A Range: Steady-25A Turns; 150A Turns Inrush for 10 Seconds

2-20A & 5-50A Ranges: Steady-50A Turns; 300A Turns Inrush for 10 Seconds

Trip Point Hysteresis: -5% Overcurrent sensing  
+5% Undercurrent sensing

#### Response Times:

Sensing Delay on Start-up: Fixed values from 0-6 seconds in one second increments

Time Delay on Trip (Relay ON): Adjustable 0.5-50 seconds or 0.1-7 seconds

Time Delay on Reset (Relay OFF): 100ms

Reset Time: 400ms

#### Output Contacts:

10 Amperes @ 240VAC, General Purpose

8 Amperes @ 28VDC, Resistive

1/4HP @ 120/240VAC

B300

#### Life:

Mechanical: 10,000,000 operations

Full Load: 100,000 operations

**Temperature:** Operating: -28° to 65°C (-18° to 149°F)

Storage: -40° to 85°C (-40° to 185°F)

**Indicator LED:** Red ON Steady when Fault occurs

#### Mounting:

Surface mount with two (2) #6 screws

#### Termination:

0.25" male quick-connect terminals

#### Approvals:



### DIMENSIONS

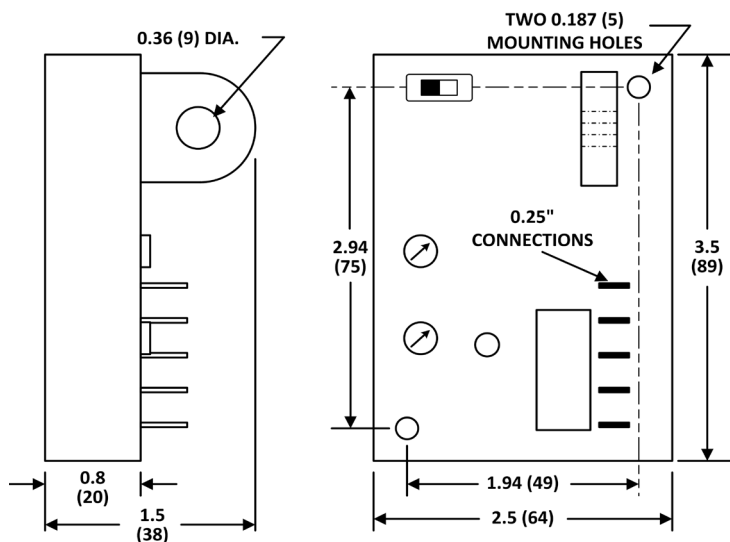

All Dimensions in Inches (Millimeters)

### CONNECTION DIAGRAM

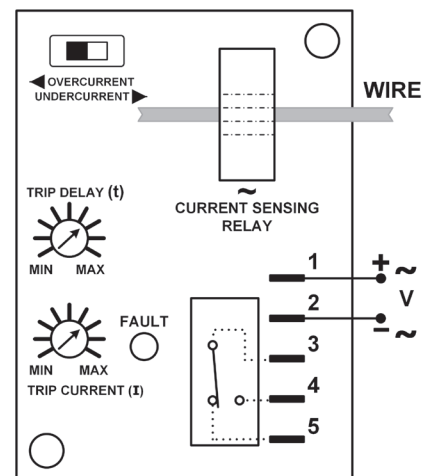

# AC OVERCURRENT COKP SERIES



- ◆ Monitors AC currents for overcurrent conditions
- ◆ Three separate current monitoring ranges covering 0.1 - 10 amperes
- ◆ External CT can be used to extend ranges
- ◆ Adjustable Pick-up and Drop-out Settings
- ◆ Adjustable time delay of 0.1-10 seconds on pick-up
- ◆ LED indicates output relay status
- ◆ Uses industry-standard 8 pin octal socket
- ◆ 10A SPDT output contacts



Current sensing relays can be used in several applications where protection of sensitive or expensive equipment against over or under current conditions is required, such as detecting (sensing) conveyor jam-up conditions, machine tool wear, no load conditions or monitoring status of heater or lamp loads.

The COKP Series is used to detect an overcurrent condition. The pick-up current setting is user-adjustable within one of three ranges as shown in the Product Selection Table below. An external current transformer can be used to extend the range of these products. The drop-out setting is adjustable from 50-95% of the selected pick-up setting. The relay will energize when the monitored AC current is above the pick-up setting for a period longer than the adjustable time delay ( $t$ ) of 0.1-10 seconds. This delay prevents nuisance tripping caused by inrush currents. It will de-energize when the monitored AC current is below the drop-out setting.

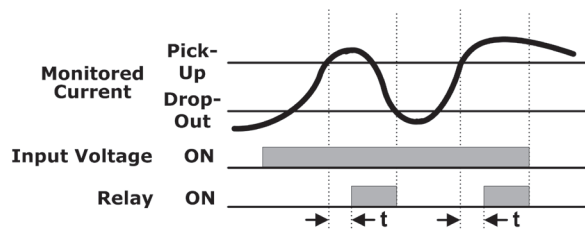

PICK-UP SETTING	DROP-OUT SETTING	INPUT VOLTAGE	CURRENT RANGE MONITORED	CATALOG NUMBER	WIRING/SOCKET
Adjustable (Across Monitored Range)	Adjustable (From 50-95% of Pick-Up)	24V AC	0.1 - 1A 0.5 - 5A 1 - 10A	COKP01A68 COKP05A68 COKP10A68	<p>DIAGRAM 21</p>
		120V AC	0.1 - 1A 0.5 - 5A 1 - 10A	COKP01A62 COKP05A62 COKP10A62	



Better. By Design.

**800.238.7474**

[WWW.MACROMATIC.COM](http://WWW.MACROMATIC.COM)

[SALES@MACROMATIC.COM](mailto:SALES@MACROMATIC.COM)

Sockets & Accessories available

# AC OVERCURRENT COKP SERIES

## APPLICATION DATA

### Input Voltage Tolerance:

AC Operation: +10/-15% of nominal at 50/60 Hz.

### Load (Burden):

Less than 5VA

### Current Settings:

Pick-up: Adjustable throughout current range monitored

Drop-out: Adjustable from 50-95% of pick-up setting

### Response Times:

Pick-up: Adjustable 0.1-10 seconds

Drop-out: Fixed 100ms

### Output Contacts:

10A @ 240V AC / 7A @ 28V DC SPDT, 1/4 HP @ 120V AC (N.O.)

### Life:

Mechanical: 10,000,000 operations

Full Load: 100,000 operations

**Temperature:** Operating: -28° to 65°C (-18° to 149° F)

Storage: -40° to 85°C (-40° to 185°F)

**Indicator LED:** Green when Input Voltage is applied; Red when Relay is energized

**Reset:** Automatic

### Mounting:

Requires 8 pin octal socket (Macromatic 70169-D or equivalent)

### Approvals:



## DIMENSIONS

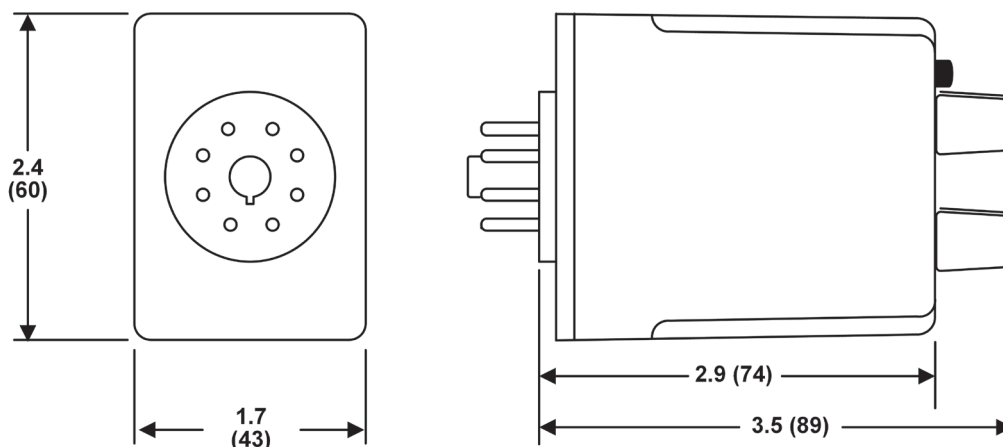

All Dimensions in  
Inches (Millimeters)

# AC/DC OVERCURRENT CAP SERIES



- ◆ Equivalent to LIRT and DIRT products from Crouzet
- ◆ Monitors for overcurrent conditions
- ◆ Each unit can monitor three current ranges for both AC & DC
- ◆ External CT can be used to extend ranges
- ◆ Adjustable Pick-up & Drop-out Setting
- ◆ Adjustable Sensing Delay on Power-up
- ◆ Non-Latching & Latching modes
- ◆ LED indicates relay status
- ◆ 11 Pin Plug-in socket can be DIN rail-mounted or panel-mounted
- ◆ 10A SPDT output contacts



Better. By Design.

**800.238.7474**

[WWW.MACROMATIC.COM](http://WWW.MACROMATIC.COM)

[SALES@MACROMATIC.COM](mailto:SALES@MACROMATIC.COM)

The CAP Series current sensing relay is used to detect an AC or DC overcurrent condition. It has two operating modes: non-latching or latching. Each relay has three top-mounted potentiometers: one for selecting the pick-up setting within the selected monitored current range (“Threshold”), one for selecting the drop-out setting of 5-50% below pick-up setting (“Hysteresis”), and one for setting the start-up sensing delay ( $t_s$ ). This delay, which is adjustable from 0.1 – 10 seconds, inhibits energization of the output relay during the start-up period.

CAP Series relays have three built-in current ranges (see right) to monitor both AC & DC current. Each one is easily selectable by connecting to the corresponding terminal and to the COM terminal (see Wiring Diagram below).

DC	AC
5 – 100mA	3.5 – 70.7mA
0.05 – 1A	0.035 – 0.707A
0.5 – 10A	0.35 – 7.07A

### Non-Latching Mode:

The unit will operate in the non-latching mode if no circuit is completed across pins 9 & 11. After input voltage is applied (LED is Green) and the start-up sensing delay ( $t_s$ ) of 0.1 – 10 seconds is completed, the relay will energize when the monitored current is above the adjustable pick-up setting (“Threshold”). The LED will be Red. It will de-energize when the monitored current goes below the adjustable drop-out setting (“Hysteresis”) by 5-50% of the selected pick-up setting or when input voltage is removed. The LED will be Green.

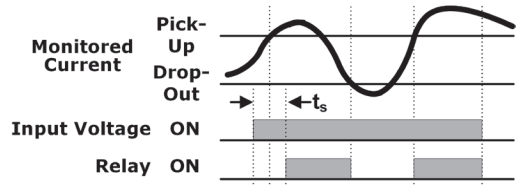

### Latching Mode:

The unit will operate in the latching mode if a N.C. contact (Memory S2) is connected across pins 9 & 11 (see Wiring Diagram). After input voltage is applied (LED is Green) and the start-up sensing delay ( $t_s$ ) of 0.1 – 10 seconds is completed, the relay will energize when the monitored current is above the adjustable pick-up setting (“Threshold”). The LED will be Red. It will de-energize when the monitored current goes below the adjustable drop-out setting (“Hysteresis”) by 5-50% of the selected pick-up setting and the N.C. contact (Memory S2) is opened, or when input voltage is removed. The LED will be Green. It is recommended to set the Hysteresis at 5% when in the latching mode.

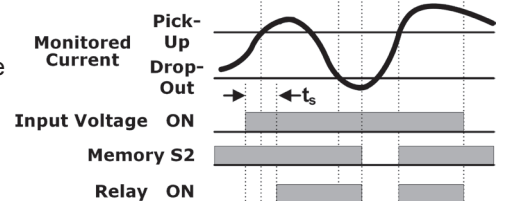

INPUT VOLTAGE	CATALOG NUMBER	WIRING/SOCKET
24V AC	CAP10AD68	<p>11 Pin 70170-D</p> <p>DIAGRAM 221</p>
120V AC	CAP10AD62	

Sockets & Accessories available



# AC/DC OVERCURRENT CAP SERIES

## APPLICATION DATA

**Input Voltage Tolerance:** +10/-15% of nominal at 50/60 Hz.

**Load (Burden):** Less than 5VA

**Current Settings:**

Pick-up (Threshold): Adjustable throughout monitored current range  
Drop-out (Hysteresis): Adjustable from 5-50% below pick-up setting

**Monitored Current Ranges:**

DC	AC
5 – 100mA	3.5 – 70.7mA
0.05 – 1A	0.035 – 0.707A
0.5 – 10A	0.35 – 7.07A

**Response Times:**

Pick-up & Drop-out: Fixed 100ms  
Sensing delay on power-up ( $t_s$ ): 0.1 – 10 seconds

**Output Contacts:**

10A @ 240V AC / 7A @ 28V DC SPDT, 1/4 HP @ 120V AC (N.O.)

**Life:**

Mechanical: 10,000,000 operations  
Full Load: 100,000 operations

**Temperature:** Operating: -28° to 55° C (-18° to 131° F)  
Storage: -40° to 85° C (-40° to 185° F)

**Indicator LED:** Green when Input Voltage is applied; Red when Relay is energized

**Mounting:** Requires an 11 pin octal socket (Macromatic 70170-D) that can be mounted on 35mm DIN rail or panel-mounted with two screws

**Approvals:**    
File #E109466  
with Appropriate Macromatic Socket

## DIMENSIONS

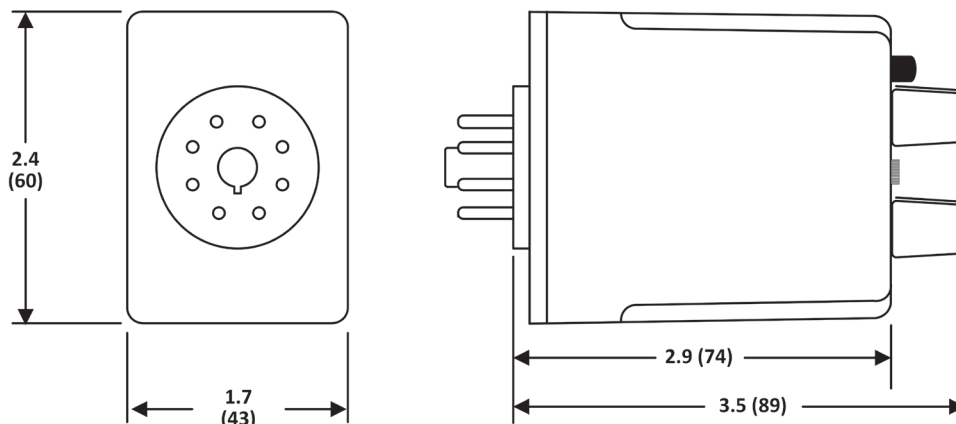

All Dimensions in  
Inches (Millimeters)

# SOCKETS & ACCESSORIES

## 8 Pin Octal Socket- Surface or DIN Rail-Mounted

- ◆ 10A @ 600V
- ◆ 1 or 2 #12-20 AWG Wire
- ◆ Pressure Wire Clamp Terminations
- ◆ Recommended Tightening Torque  
12 in-lbs



File #E169693 File #LR701114



Catalog Number:  
70169-D

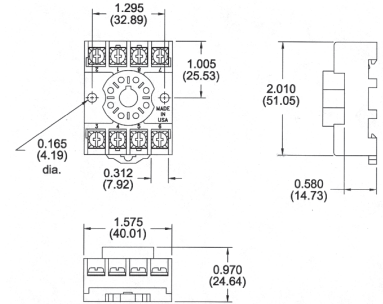
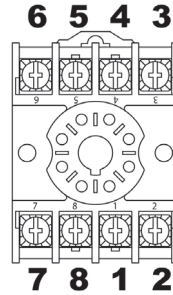

## 11 Pin Octal Socket Surface or DIN Rail-Mounted

- ◆ 10A @ 300V
- ◆ 1 or 2 #12-20 AWG Wire
- ◆ Pressure Wire Clamp Terminations
- ◆ Recommended Tightening Torque  
12 in-lbs



File #E169693 File #LR701114



Catalog Number:  
70170-D

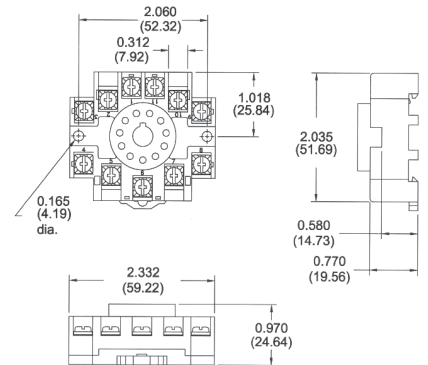
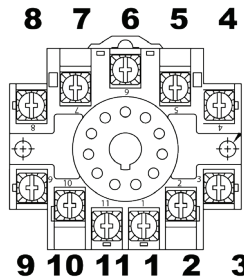

## Hold Down Spring Catalog Number 70166

Can be used for:

- ◆ Panel-Mounted Sockets
- ◆ Sockets Mounted to 35mm DIN Rail \*

\* Requires two #8, 3/4" length machine screws with washers & nuts--contact Macromatic or [www.macromatic.com/70166](http://www.macromatic.com/70166) for more information.





# MACROMATIC INDUSTRIAL CONTROLS

Macromatic Industrial Controls, Inc. designs and manufactures control and monitoring products to manage electrical processes and to protect equipment from damaging fault conditions.

Our products are used in control systems for a range of industries including water/waste water, pump and motor control, irrigation, oil and gas, HVACR, material handling, lifts and elevator and other systems requiring process control and protection.

Customers depend on Macromatic for short lead-times, custom product engineering and the best technical support in the industry. We continuously improve our products by integrating new technology and improving our manufacturing processes. The result is innovative, reliable products, delivered on-time, every time.

Visit [www.macromatic.com](http://www.macromatic.com) today.



Better. By Design.

800.238.7474 | [WWW.MACROMATIC.COM](http://WWW.MACROMATIC.COM) | [SALES@MACROMATIC.COM](mailto:SALES@MACROMATIC.COM)

# MACROMATIC INDUSTRIAL CONTROLS

## FAMILY OF PRODUCTS

MACROMATIC INDUSTRIAL CONTROLS

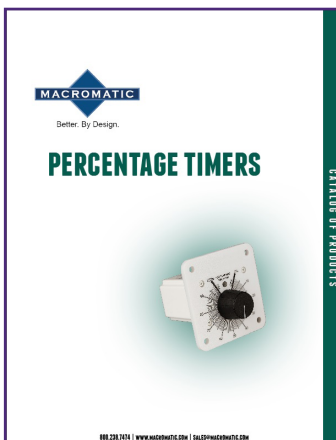
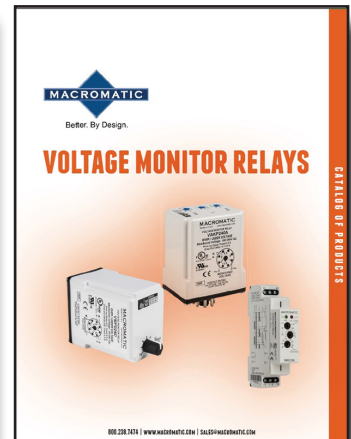
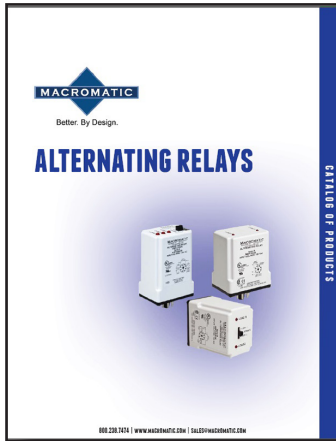

Better. By Design.

800.238.7474 | [WWW.MACROMATIC.COM](http://www.macromatic.com) | [SALES@MACROMATIC.COM](mailto:SALES@MACROMATIC.COM)

01/08/20

Specifications subject to change without notice | Macromatic is a registered trademark of Macromatic Industrial Controls, Inc.