

Round Water-resistive Smartclick Connectors That Reduce Installation Work

- A newly developed lock mechanism that is compatible with round M12 connectors.
- Simply insert the Connectors, then turn them approximately 1/8 of a turn to lock.
- A positive click indicates locking.
- Features the same degree of protection (IP67) as M12 connectors.
- A full line-up of models is planned.
- Connectors with Cables are UL approved.



Refer to *Safety Precautions* on page 24.

Ratings and Specifications

Rated current	4 A
Rated voltage	250 VDC
Contact resistance (connector)	40 mΩ max. (20 mV max., 100 mA max.)
Insulation resistance	1,000 MΩ min. (at 500 VDC)
Dielectric strength (connector)	1,500 VAC for 1 min (leakage current: 1 mA max.)
Degree of protection	IP67 (IEC60529)
Insertion tolerance	50 times min.
Lock strength	Tensile: 100 N/15 s, Torsion: 1 N·m/15 s
Cable holding strength	Tensile: 100 N/15 s, Torsion: 1 N·m/15 s (for cable diameter of 6 mm) *2
Lock operating force	0.1 to 0.25 N·m
Ambient operating temperature range	-25 to 70°C
Ambient humidity range	20% to 85%
Number of pressure-weld repairs *1	10 times max. (Limited to the same external diameter and wire diameter.)

*1. Only XS5C/G (IDC models)



*2. Refer to product specifications for details.

Materials and Finishes

Model		XS5F/H/W	XS5R	XS5M/P	XS5C/G (Crimping, Soldering)	XS5C/G (Screw-on)	XS5C/G (IDC models)
Contacts	Material	Phosphor bronze	Phosphor bronze or Brass	Phosphor bronze	Brass	Phosphor bronze or Brass	Phosphor bronze
	Finish	Nickel base, 0.4-μm gold plating					Nickel base, 0.15-μm gold plating
Fixtures		Nickel-plated zinc alloy					
Fixtures (Lock) *		Stainless					
Pin block		PBT resin (UL94V-0)					
O-ring		Rubber					
Overmolding/Cover		Soft PBT resin (UL94V-0)		---	PBT resin (UL94V-0)		
Cable	Fire-retardant, Robot cable	UL AWM2464 CL3, 6 mm dia., AWG20 (0.5mm ²) Structure: 0.08 mm/110 wires		---			
	Oil-resistant polyurethane cable	6 mm dia. AWG20 (0.5mm ²) Structure: 0.12 mm/45 wires		---			
	Spatter-resistant Cable	6.6 mm dia. AWG20 (0.5mm ²) Structure: 0.08 mm/100 wires		---			
Seal resin		---		Epoxy resin (UL94V-0)	---		
Power supply wires		---		UL1007 AWG20	---		

*Only plug

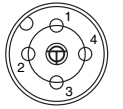
Connector Pinout Diagram (from Mating Side)

Item	No. of poles	4 poles
DC type	Male (plug) contacts	
	Female (socket) contacts	

Connection Combinations

OMRON model No.		Smartclick Plug Connectors	M12 Plug Connectors
		XS5H, XS5G, XS5W (plug side), XS5R (plug side), XS5M	XS2H, XS2G, XS2W (plug side), XS2R (plug side), XS2M
Smartclick Socket Connectors	XS5F, XS5C, XS5W (socket side), XS5R (socket side), XS5P	⊗	○
M12 Socket Connectors	XS2F, XS2C, XS2W (socket side), XS2R (socket side), XS2P	○	○

 Smartclick is a registered trademark of the OMRON Corporation.

⊗ : Connected by twisting.

○ : Connected by screwing.

Note: The XS□M and XS□P cannot mate with each other.



XS5W Connectors Connected to Cable, Socket and Plug on Cable Ends

- Fire-retardant, Robot cable
- Oil-resistant Polyurethane Cable
- Spatter-resistant Cable

XS5W-D42□-□81-F
 XS5W-D42□-□81-P
 XS5W-D421-□81-SA

Dimensions

(Unit: mm)

Straight/straight

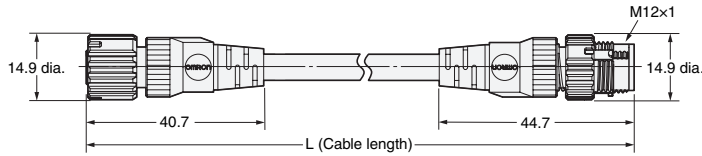

Angled/angled

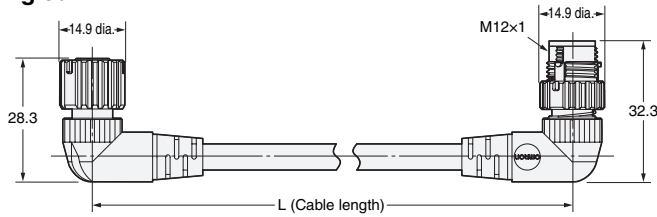

Straight/angled

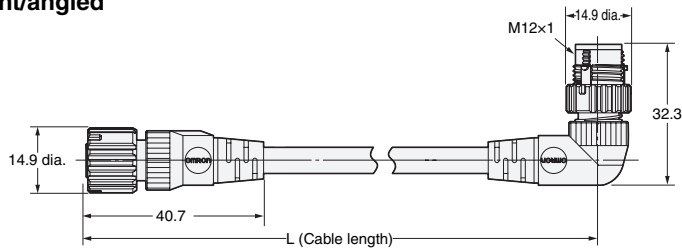

Angled/straight

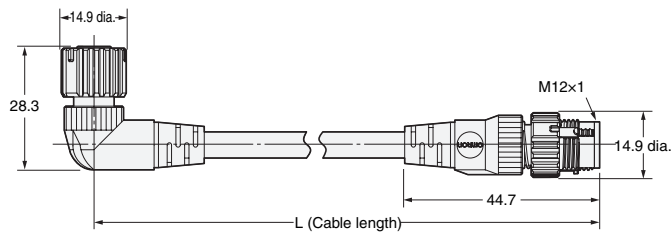

Wiring Diagram for 4 Cores

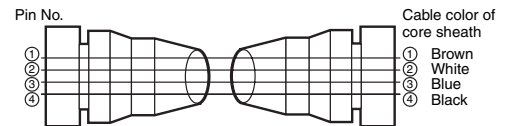

Note: Oil-resistant Polyurethane Cables (XS5W-D42□-□81-P) and Spatter-resistant Cable (XS5W-D421-□81-SA) have black covers. Fire-retardant, Robot cable (XS5W-D42□-□81-F) have warm gray covers.

Model Number Legend

XS5W-D42 **-** **81-**

1
2
3
4
5
6
7
8
9

Use this model number legend to identify products from their model number. When ordering, use a model number from the table in *Ordering Information*.

1. Type

W: Connectors connected to cable, socket and plug on cable ends

2. Mating Section Form

D: DC

3. Connector Poles

4: 4 poles

4. Contact Plating

2: 0.4-μm gold plating

5. Cable Connection Direction

- 1: Straight/straight
- 2: Angled/angled
- 3: Straight (Socket)/angled (Plug)
- 4: Angled (Socket)/straight (Plug)

6. Cable Length

- C: 1 m
- D: 2 m
- E: 3 m
- G: 5 m
- J: 10m

7. Connections

8: ① Brown, ② White, ③ Blue, ④ Black (Numbers inside circles are terminal numbers)

8. Connectors on One End/Both Ends

1: Both ends

9. Cable Specifications

- F: Fire-retardant, Robot cable
- P: Oil-resistant Polyurethane Cable
- SA: Spatter-resistant Cable

Ordering Information

Cable specifications	Cable length L (m)	Cable outer diameter (mm)	Straight/straight	Angled/angled	Minimum order	UL
			Model			
Fire-retardant, Robot cable	1	6	XS5W-D421-C81-F	---	10	Yes
	2		XS5W-D421-D81-F	XS5W-D422-D81-F	5	
	3		XS5W-D421-E81-F	---		
	5		XS5W-D421-G81-F	XS5W-D422-G81-F		
	10		XS5W-D421-J81-F	---	1	
Oil-resistant Polyurethane Cable	2	6	XS5W-D421-D81-P	---	5	---
	5		XS5W-D421-G81-P	---	1	
	10		XS5W-D421-J81-P	---		
Spatter-resistant Cable	2	6.6	XS5W-D421-D81-SA	---	5	---
	5		XS5W-D421-G81-SA	---		

Cable specifications	Cable length L (m)	Cable outer diameter (mm)	Straight (Socket)/angled (Plug)	Angled (Socket)/straight (Plug)	Minimum order	UL
			Model			
Fire-retardant, Robot cable	2	6	XS5W-D423-D81-F	XS5W-D424-D81-F	5	Yes
	5		XS5W-D423-G81-F	XS5W-D424-G81-F		

XS5F Connector Connected to Cable, Socket on One Cable End

- Fire-retardant, Robot cable
- Oil-resistant Polyurethane Cable
- Spatter-resistant Cable

XS5F-D42□-□80-F
 XS5F-D42□-□80-P
 XS5F-D421-□80-SA

Dimensions

(Unit: mm)

Straight

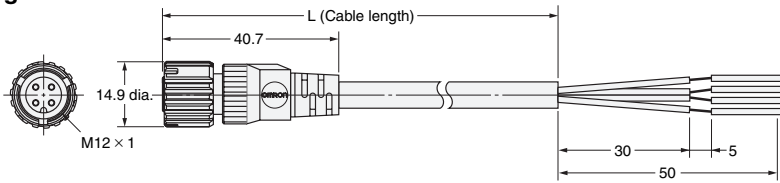

Wiring Diagram for 4 Cores

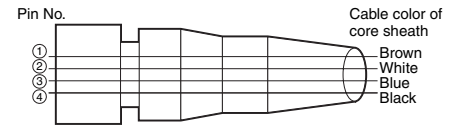

Angled

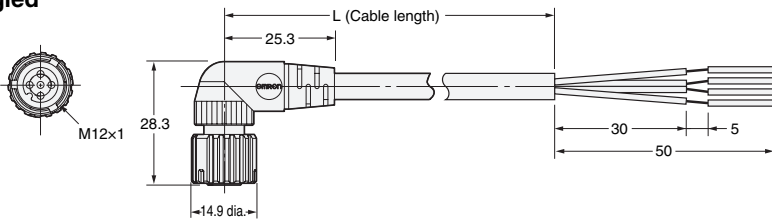

Note: Oil-resistant Polyurethane Cables (XS5F-D42□-□80-P) and Spatter-resistant Cable (XS5F-D421-□80-SA) have black covers. Fire-retardant, Robot cable (XS5F-D42□-□80-F) have warm gray covers.

Model Number Legend

XS5F-D42□-□80-□□
 1 2 3 4 5 6 7 8 9

Use this model number legend to identify products from their model number. When ordering, use a model number from the table in *Ordering Information*.

1. Type

F: Connector connected to cable, socket on one cable end

2. Mating Section Form

D: DC

3. Connector Poles

4: 4 poles

4. Contact Plating

2: 0.4-μm gold plating

5. Cable Connection Direction

1: Straight
 2: Angled

6. Cable Length

C: 1 m D: 2 m E: 3 m
 G: 5 m J: 10 m

7. Connections

8: ① Brown, ② White, ③ Blue, ④ Black (Numbers inside circles are terminal numbers.)

8. Connectors on One End/Both Ends

0: One end

9. Cable Specification

F: Fire-retardant, Robot cable
 P: Oil-resistant Polyurethane Cable
 SA: Spatter-resistant Cable

Ordering Information

Cable specifications	Cable length L (m)	Cable outer diameter (mm)	Straight Connectors	Angled Connectors	Minimum order	UL
			Model			
Fire-retardant, Robot cable	1	6	XS5F-D421-C80-F	XS5F-D422-C80-F	10	Yes
	2		XS5F-D421-D80-F	XS5F-D422-D80-F	5	
	3		XS5F-D421-E80-F	XS5F-D422-E80-F		
	5		XS5F-D421-G80-F	XS5F-D422-G80-F		
	10		XS5F-D421-J80-F	XS5F-D422-J80-F		
Oil-resistant Polyurethane Cable	2	6	XS5F-D421-D80-P	XS5F-D422-D80-P	5	---
	5		XS5F-D421-G80-P	XS5F-D422-G80-P	1	
	10		XS5F-D421-J80-P	XS5F-D422-J80-P		
Spatter-resistant Cable	2	6.6	XS5F-D421-D80-SA	---	5	---
	5		XS5F-D421-G80-SA	---		



XS5H Connector Connected to Cable, Plug on One Cable End

- Fire-retardant, Robot cable
- Oil-resistant Polyurethane Cable
- Spatter-resistant Cable

XS5H-D42□-□80-F
 XS5H-D42□-□80-P
 XS5H-D421-□80-SA

Dimensions

(Unit: mm)

Straight

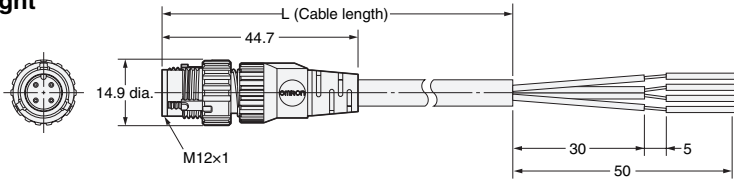

Wiring Diagram for 4 Cores

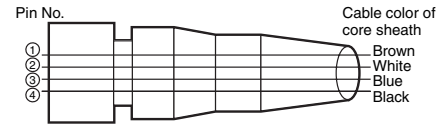

Angled

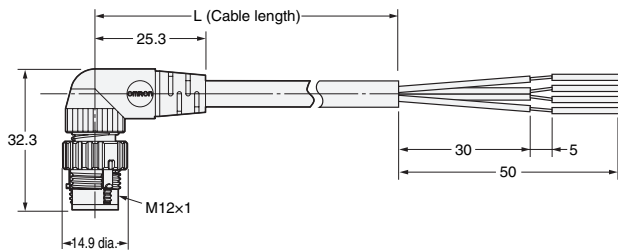

Note: Oil-resistant Polyurethane Cables (XS5H-D42□-□80-P) and Spatter-resistant Cable (XS5H-D421-□80-SA) have black covers. Fire-retardant, Robot cable (XS5H-D42□-□80-F) have warm gray covers.

Model Number Legend

XS5H-D42□-□80-□□□
 1 2 3 4 5 6 7 8 9

Use this model number legend to identify products from their model number. When ordering, use a model number from the table in *Ordering Information*.

1. Type

H: Connector connected to cable, plug on one cable end

2. Mating Section Form

D: DC

3. Connector Poles

4: 4 poles

4. Contact Plating

2: 0.4-μm gold plating

5. Cable Connection Direction

1: Straight
 2: Angled

6. Cable Length

A: 0.3 m C: 1 m D: 2 m
 G: 5 m

7. Connections

8: ① Brown, ② White, ③ Blue,
 ④ Black (Numbers inside circles are terminal numbers)

8. Connectors on One End/Both Ends

0: One end

9. Cable Specifications

F: Fire-retardant, Robot cable
 P: Oil-resistant Polyurethane Cable
 SA: Spatter-resistant Cable

Ordering Information

Cable specifications	Cable length L (m)	Cable outer diameter (mm)	Straight Connectors	Angled Connectors	Minimum order	UL
			Model			
Fire-retardant, Robot cable	0.3	6	XS5H-D421-A80-F	XS5H-D422-A80-F	10	Yes
	1		XS5H-D421-C80-F	XS5H-D422-C80-F		
	2		XS5H-D421-D80-F	XS5H-D422-D80-F	5	
	5		XS5H-D421-G80-F	XS5H-D422-G80-F		
Oil-resistant Polyurethane Cable	0.3	6.6	XS5H-D421-A80-P	XS5H-D422-A80-P	10	---
	2		XS5H-D421-D80-P	XS5H-D422-D80-P		
	5		XS5H-D421-G80-P	XS5H-D422-G80-P	5	
Spatter-resistant Cable	0.3	6.6	XS5H-D421-A80-SA	---	10	---
	1		XS5H-D421-C80-SA	---		

XS5 Eight-pole Connectors with Cables

Ordering Information

Type	Cable specification	Cable connection direction	No. of cable cores	Cable length L (m)	Applicable wire gauge	Model
Connector Connected to Cable, Socket on One End	6.3 mm dia., AWG23 (0.25 mm ²) Structure: 0.08 mm/60 wires	Straight	10	2	---	XS5F-D821-DH0-R
				5		XS5F-D821-GH0-R
				10		XS5F-D821-JH0-R
Panel-mounting Plug	---	---	---	---	AWG22 to AWG28	XS5M-D827-4

Pins and Cable Lead Colors

XS5F cable lead colors	Pin No.							
	①	②	③	④	⑤	⑥	⑦	⑧
	White	Brown	Green	Yellow	Gray	Pink	Blue	Red

Ratings and Specifications

Rated current	1.5 A
Rated voltage	36 VDC
Contact resistance	40 mΩ max. (at 20 mV DC max., 100 mA max.)
Insulation resistance	1,000 MΩ min. (at 500 VDC)
Dielectric strength	1,000 VAC for 1 min (leakage current: 1 mA max.)
Degree of protection	IP67 (IEC 60529)
Insertion tolerance	50 times
Ambient operating temperature range	-25 to 70°C
Ambient operating humidity range	20% to 85%

Materials and Finishes

Contacts	Brass/nickel base, 0.4-μm gold plating
Fixtures	Nickel-plated zinc alloy *1
Body	Nickel-plated zinc alloy *2
Nuts	Nickel-plated brass *2
Fixtures (lock)	Stainless *2
Contact block	PBT resin (UL94V-0), light gray
Cover *1	Soft PBT resin (UL94V-0)
Seal resin *2	Rubber
O-ring*1	

*1. XS5F only.
*2. XS5M only.

Dimensions

(Unit: mm)

XS5F-D821-H0-R Connector Connected to Cable, Socket on One End

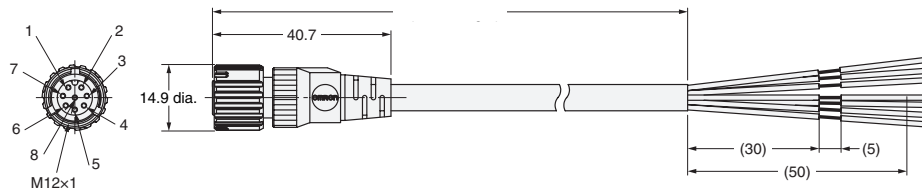

XS5M-D827-4 Front-locking, Panel-mounting Plug

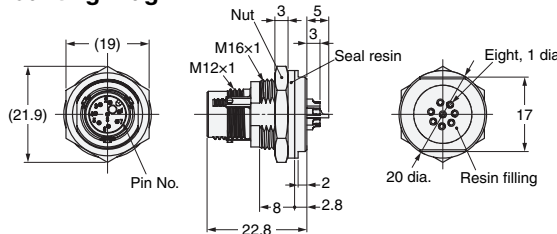

Panel Cutout

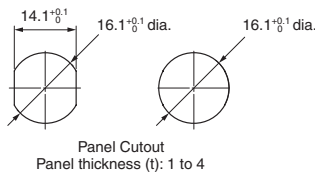

XS5G Assembly Connector Plugs

Dimensions

(Unit: mm)

**XS5G-D418 (IDC Model)
Straight Connectors**

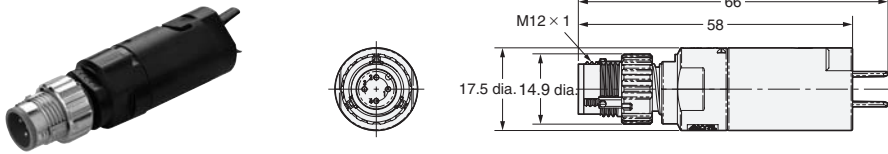

**XS5G-D4C□ (Crimping Model)
XS5G-D42□ (Soldering Model)
Straight Connectors**

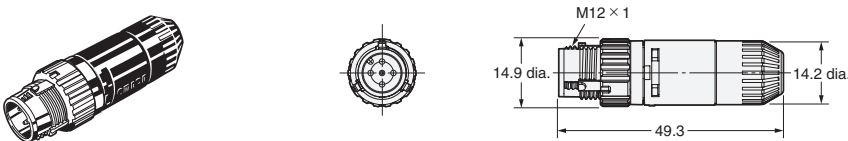

**XS5G-D42□ (Soldering Model)
Angled Connectors**

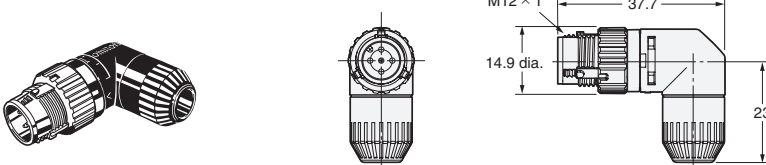

**XS5G-D□S□ (Screw-on Connectors, Applicable Cable Outer Diameter: 7 or 8 mm)
Straight Connectors**

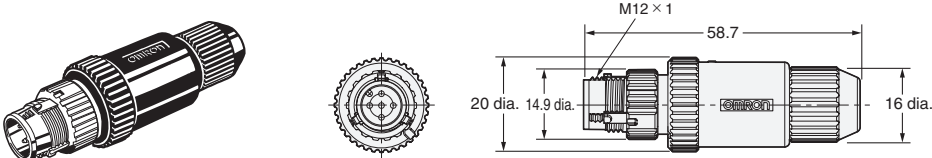

**XS5G-D□S□ (Screw-on Connectors, Applicable Cable Outer Diameter: 3, 4, or 6 mm)
Straight Connectors**

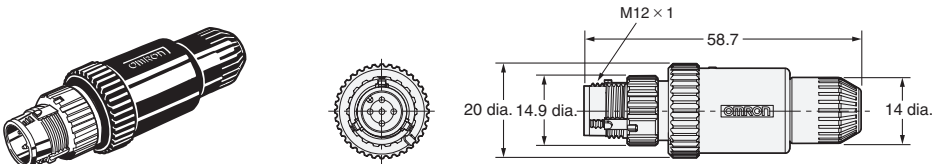

**XS5G-D□S□ (Screw-on Connectors)
Angled Connectors**

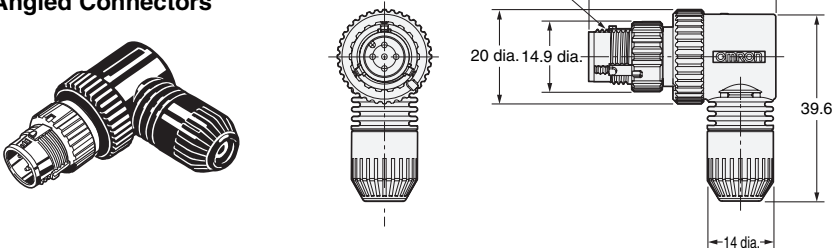

Ordering Information

No. of poles	Connection method	Suitable cable dia. (mm)	Core conductor size (mm ²)	Suitable sheath material	Straight Connectors	Angled Connectors	Minimum order			
					Model					
4	IDC	3 to 8 mm	0.14 to 0.75 *1	PVC, PE, PUR	XS5G-D418	---	50			
		6 mm (5 to 6)	0.18 to 0.3 0.5 to 0.75 *2		XS5G-D4C1	---				
	Crimping	4 mm (4 to 5)			0.5 max.	XS5G-D4C3		---		
		3 mm (3 to 4)	XS5G-D4C5			---				
	Soldering	6 mm (5 to 6)	0.18 to 0.75		XS5G-D421	XS5G-D422				
		4 mm (4 to 5)			XS5G-D423	XS5G-D424				
	Screw-on	3 mm (3 to 4)	0.18 to 0.75		XS5G-D425	XS5G-D426				
		6 mm (5 to 6)			XS5G-D4S1	XS5G-D4S2				
		4 mm (4 to 5)			XS5G-D4S3	XS5G-D4S4				
		3 mm (3 to 4)			XS5G-D4S5	XS5G-D4S6				
		8 mm (7 to 8)			XS5G-D4S7	---				
		7 mm (6 to 7)			XS5G-D4S9	---				
		5			Screw-on	6 mm (5 to 6)		0.18 to 0.75	XS5G-D5S1	---
						4 mm (4 to 5)			XS5G-D5S3	---
3 mm (3 to 4)	XS5G-D5S5		---							
8 mm (7 to 8)	XS5G-D5S7		---							
7 mm (6 to 7)	XS5G-D5S9		---							

*1. Minimum wire diameter: 0.08 mm, Outer diameter of wire covering: 0.7 to 2.6 mm, Material of wire covering: PVC and PE

*2. There are two types of contacts.

Note: XS5G Screw-on Plugs cannot be connected to side by side to the CN1 and CN2 connectors of XS2R or XS5R Y-Joint Sockets/Plugs. Use one of the above cables. If you do not use one of these cables, there is a possibility that the performance can't be met. Ask your OMRON representative about selecting a cable of other than above.

XS5U (Crimping Pin for XS5G)

Dimensions

(Unit: mm)

XS5U-312□
Plug Pin

* A special tool must be used for crimping. For details, refer to page 18.

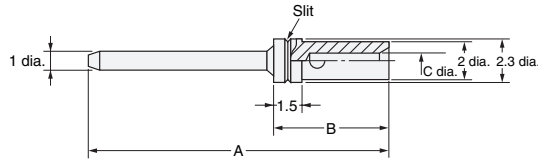
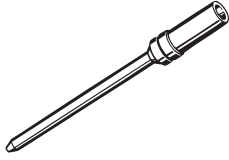

Dimensions

Model	Suitable core size (mm ²)	Dimension (mm)			No. of slits
		A	B	C	
XS5U-3121	0.18 to 0.3	22.6	6.1	0.8	1
XS5U-3122	0.5 to 0.75	22.7	6.2	1.3	0

Ordering Information

Suitable core size (mm ²)	Model	Minimum order
0.18 to 0.3	XS5U-3121	100
0.5 to 0.75	XS5U-3122	

Note: Orders are accepted in multiples of the minimum order.

XS5C Assembly Connector Sockets

Dimensions

(Unit: mm)

**XS5C-D418 (IDC Model)
Straight Connectors**

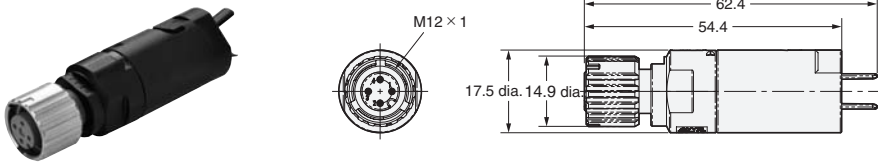

**XS5C-D4C□ (Crimping Model)
XS5C-D42□ (Soldering Model)
Straight Connectors**

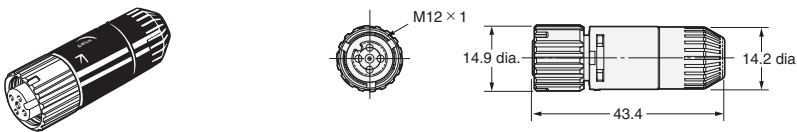

**XS5C-D4C□ (Crimping Model)
XS5C-D42□ (Soldering Model)
Angled Connectors**

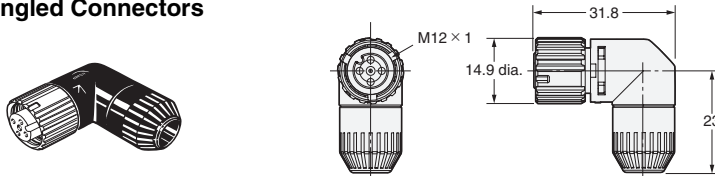

**XS5C-D□S□ (Screw-on Connectors, Applicable Cable Outer Diameter: 7 or 8 mm)
Straight Connectors**

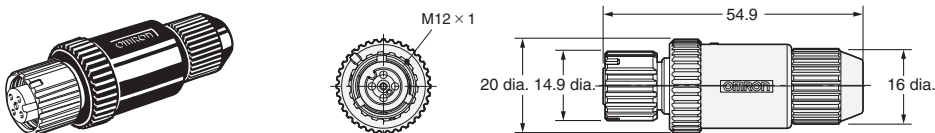

**XS5C-D□S□ (Screw-on Connectors, Applicable Cable Outer Diameter: 3, 4, or 6 mm)
Straight Connectors**

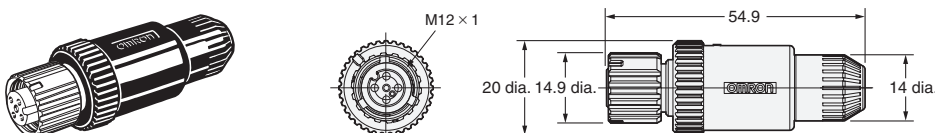

**XS5C-D□S□ (Screw-on Connectors)
Angled Connectors**

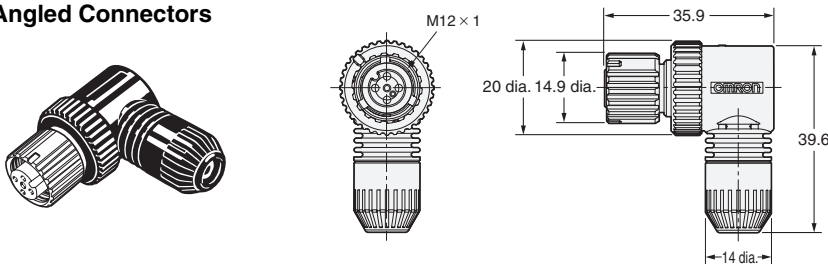

Ordering Information

No. of poles	Connection method	Suitable cable dia. (mm)	Core conductor size (mm ²)	Suitable sheath material	Straight Connectors	Angled Connectors	Minimum order	
					Model			
4	IDC	3 to 8 mm	0.14 to 0.75 *1	PVC, PE, PUR	XS5C-D418	---	50	
		6 mm (5 to 6)	0.18 to 0.3 0.5 to 0.75 ² *2		XS5C-D4C1	XS5C-D4C2		
	Crimping	4 mm (4 to 5)			XS5C-D4C3	XS5C-D4C4		
		3 mm (3 to 4)	XS5C-D4C5		XS5C-D4C6			
	Soldering	6 mm (5 to 6)	0.5 max.		XS5C-D421	XS5C-D422		
		4 mm (4 to 5)			XS5C-D423	XS5C-D424		
	Screw-on	3 mm (3 to 4)	0.18 to 0.75		XS5C-D425	XS5C-D426		
		6 mm (5 to 6)			XS5C-D4S1	XS5C-D4S2		
		4 mm (4 to 5)			XS5C-D4S3	XS5C-D4S4		
		3 mm (3 to 4)			XS5C-D4S5	XS5C-D4S6		
		8 mm (7 to 8)			XS5C-D4S7	---		
		7 mm (6 to 7)			XS5C-D4S9	---		
	5	Screw-on	6 mm (5 to 6)		0.18 to 0.75	XS5C-D5S1		---
			4 mm (4 to 5)			XS5C-D5S3		---
3 mm (3 to 4)			XS5C-D5S5	---				
8 mm (7 to 8)			XS5C-D5S7	---				
7 mm (6 to 7)			XS5C-D5S9	---				

*1. Minimum wire diameter: 0.08 mm, Outer diameter of wire covering: 0.7 to 2.6 mm, Material of wire covering: PVC and PE

*2. There are two types of contacts.

Note: Use one of the above cables. If you do not use one of these cables, there is a possibility that the performance can't be met. Ask your OMRON representative about selecting a cable of other than above.

XS5U (Crimping Pin for XS5C)

Dimensions

(Unit: mm)

XS5U-222□
Socket Pin

* A special tool must be used for crimping. For details, refer to page 18.

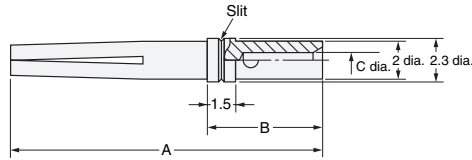
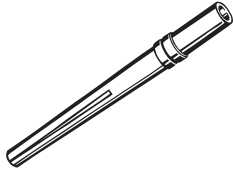

Dimensions

Model	Suitable core size (mm ²)	Dimension (mm)			No. of slits
		A	B	C	
XS5U-2221	0.18 to 0.3	16.7	6.1	0.8	1
XS5U-2222	0.5 to 0.75	16.8	6.2	1.3	0

Ordering Information

Suitable core size (mm ²)	Model	Minimum order
0.18 to 0.3	XS5U-2221	100
0.5 to 0.75	XS5U-2222	

Orders are accepted in multiples of the minimum order.

XS5R Y-Joint Plug/Socket Connectors

Dimensions

(Unit: mm)

XS5R-D426-□11-F

Connectors on Both Ends (Y-Joint Plug/Socket)

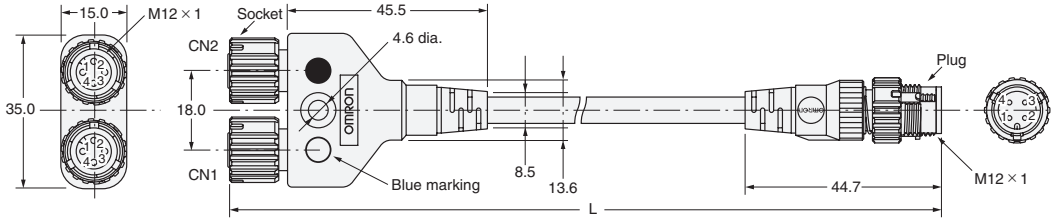

Wiring Diagram

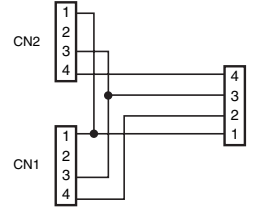

XS5R-D426-□10-F

Connectors on One Cable End (Y-Joint Socket)

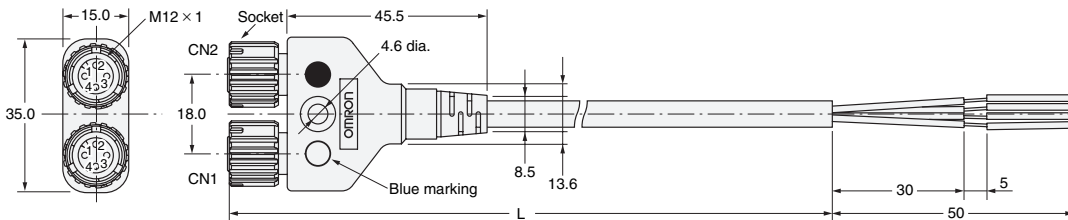

Wiring Diagram

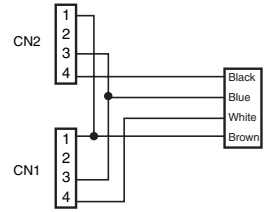

XS5R-D426-□

Y-Joint Plug/Socket without Cable

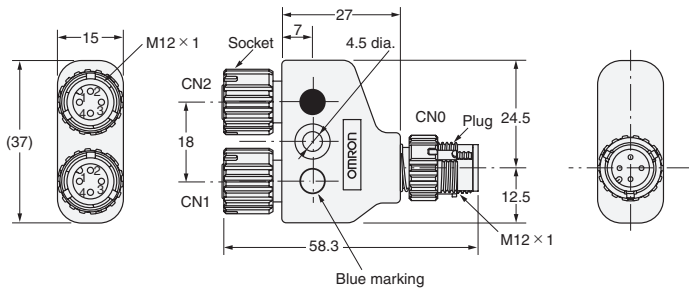

Wiring Diagram

XS5R-D426-1

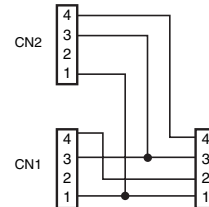

XS5R-D426-5

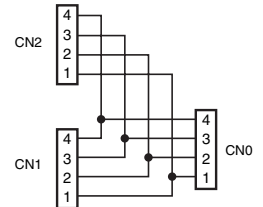

Ordering Information

Cable	Connector	Cable length (m)	Model	Minimum order
With cable	Connectors on both cable ends	0.5	XS5R-D426-B11-F	10
		1	XS5R-D426-C11-F	
		2	XS5R-D426-D11-F	
	Connector on one cable end	3	XS5R-D426-E11-F	5
		2	XS5R-D426-D10-F	
	5	XS5R-D426-G10-F		
Cable	Connector	Cable length (m)	Model	Minimum order
With no cable	Y-Joint Plug/Socket	—	XS5R-D426-1	10
			XS5R-D426-5	

Note 1. Ask your OMRON representative about other specifications.

2. XS2G/XS5G Assembled Connectors with screw connections cannot be connected to both CN1 and CN2 at the same time.

XS5P Panel-mounting Sockets

Dimensions

XS5P-D426-5

Rear-locking Socket Connected to Wires

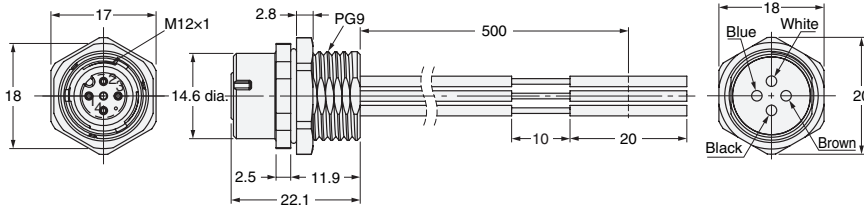

Wiring

Pin number	Color
1	Brown
2	White
3	Blue
4	Black

Wire Specifications

Item	Specification	
Specification	UL1007	
Nominal size	AWG20	
Config-uration	Number of wires	21
	Wire diameter	0.18
	Standard outer diameter	1.8

XS5P-D427-5

Front-locking Socket Connected to Wires

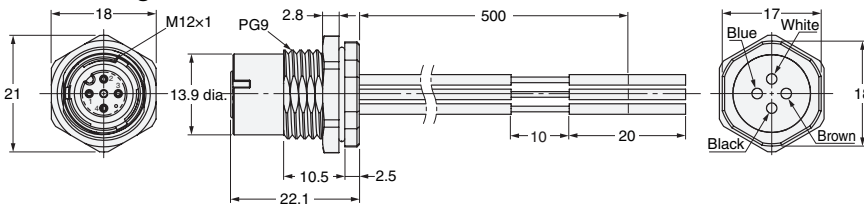

XS5P-D426-4 Rear-locking Socket with Solder Cup Pins

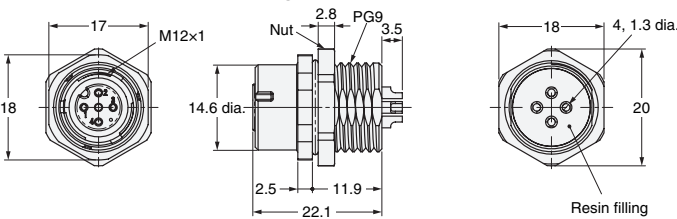

XS5P-D526-4 Rear-locking Socket with Solder Cup Pins

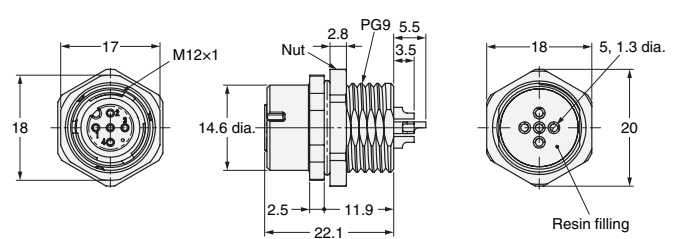

XS5P-D427-4 Front-locking Socket with Solder Cup Pins

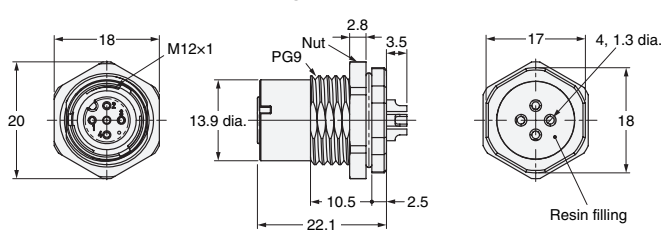

XS5P-D527-4 Front-locking Socket with Solder Cup Pins

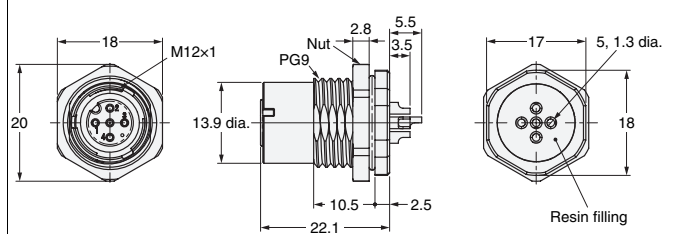

Panel Cutout

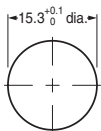

Panel Cutout Dimension
Panel thickness = 1 to 4 mm

Note 1. The panel cutout dimension is the same for Front-locking and Rear-locking Sockets.
2. Rotational positioning is not possible for connector rotation.

Ordering Information

Type	No. of poles	Lock	Cable length (m)	Model	Minimum order
With cable	4	Rear lock	0.5	XS5P-D426-5	10
		Front lock		XS5P-D427-5	
Type	No. of poles	Lock	Applicable wires	Model	Minimum order
Solder cup pins	4	Rear lock	AWG20 to AWG28	XS5P-D426-4	50
		Front lock		XS5P-D427-4	
	Rear lock	XS5P-D526-4			
	Front lock	XS5P-D527-4			

XS5M Panel-mounting Plugs

Dimensions

XS5M-D426-5
Rear-locking Plug Connected to Wires

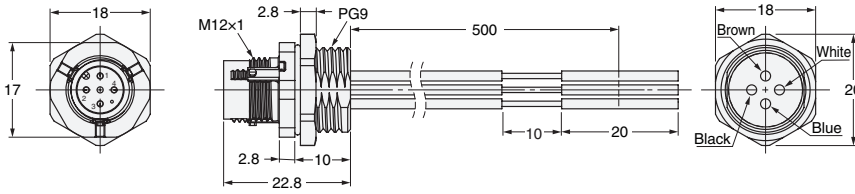

Wiring

Pin number	Color
1	Brown
2	White
3	Blue
4	Black

XS5M-D427-5
Front-locking Plug Connected to Wires

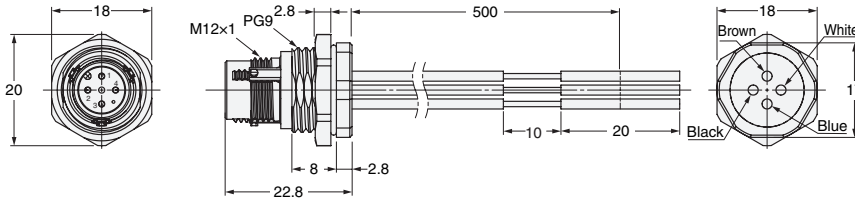

Wire Specifications

Item	Specification	
Specification	UL1007	
Nominal size	AWG20	
Configuration	Number of wires	21
	Wire diameter	0.18
	Standard outer diameter	1.8

XS5M-D426-4 Rear-locking Plug with Solder Cup Pins

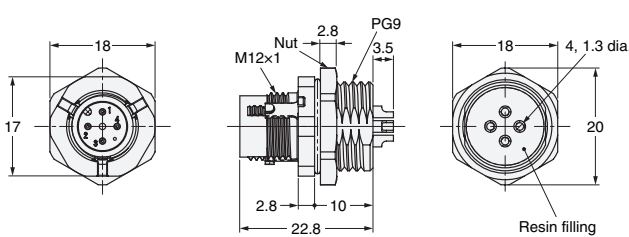

XS5M-D526-4 Rear-locking Plug with Solder Cup Pins

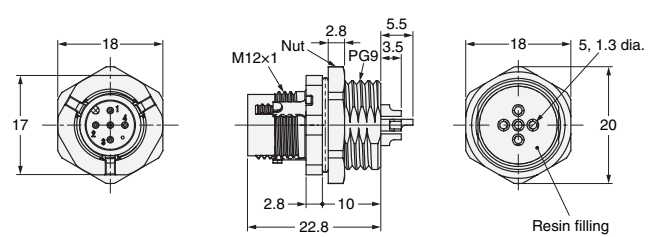

XS5M-D427-4 Front-locking Plug with Solder Cup Pins

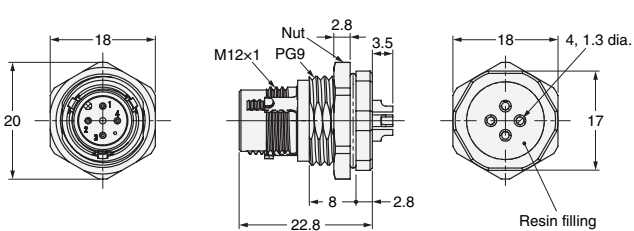

XS5M-D527-4 Front-locking Plug with Solder Cup Pins

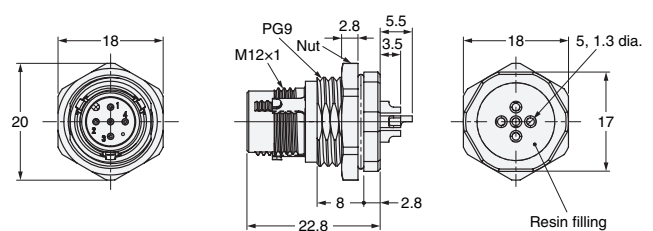

Panel Cutout

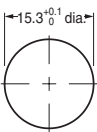

Panel Cutout Dimension
Panel thickness = 1 to 4 mm

- Note 1. The panel cutout dimension is the same for Front-locking and Rear-locking Sockets.
2. Rotational positioning is not possible for connector rotation.

Ordering Information

Type	No. of poles	Lock	Cable length (m)	Model	Minimum order
With cable	4	Rear lock	0.5	XS5M-D426-5	10
		Front lock		XS5M-D427-5	
Type	No. of poles	Lock	Applicable wires	Model	Minimum order
Solder cup pins	4	Rear lock	AWG20 to AWG28	XS5M-D426-4	50
		Front lock		XS5M-D427-4	
	5	Rear lock		XS5M-D526-4	
		Front lock		XS5M-D527-4	

Connector Covers

Water-resistant Covers

XS2Z-11

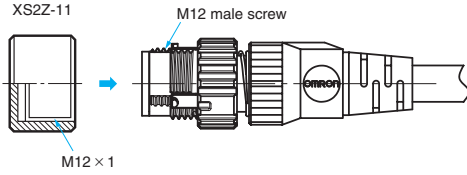

XS5Z-11

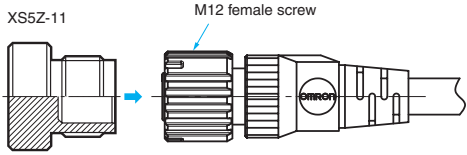
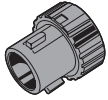

The Water-resistant Cover ensures IP67. When mounting the Water-resistant Cover to a Connector, be sure to apply a torque range between 0.39 and 0.49 N·m to tighten the Water-resistant Cover. XS5Z-11 is Smart click mechanism. There's no need to keep track of locking torque.

Model	Minimum order	Material	Suitable connector	
			Model	Mounting portion
XS2Z-11	50	Brass/nickel plated	XS5G/XS5H/XS5M/XS5R/XS5W/ XS2G/XS2H/XS2M/XS2R/XS2W	M12 male screw
XS5Z-11		PBT	XS5C/XS5F/XS5P/XS5R/XS5W/XW3D	M12 female screw

Dust Covers

XS2Z-13

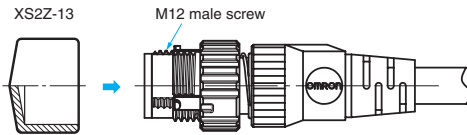

XS2Z-15/XS2Z-14

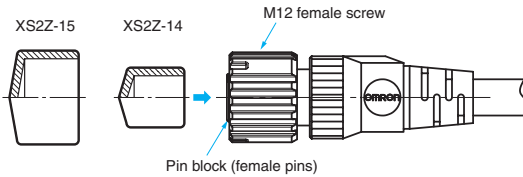

The Dust Cover is for dust prevention and does not ensure IP67 degree of protection. When mounting the Dust Cover to a connector, be sure to press the Dust Cover onto the Connector until the Connector is fully inserted into the Dust Cover.

Model	Minimum order	Material	Suitable connector	
			Model	Mounting portion
XS2Z-13	50	Rubber/black	XS5G/XS5H/XS5M/XS5R/XS5W/ XS2G/XS2H/XS2M/XS2R	M12 male screw
XS2Z-14			XS5C/XS5F/XS5P/XS5R/XS5W/ XS2C/XS2F/XS2P/XS2R/XS2W/ XW3B/XW3D	Pin block (female pins)
XS2Z-15				M12 female screw

Sputter Protective Cover

XS2Z-31

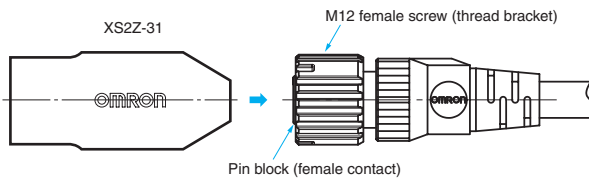
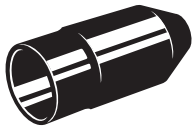

The Sputter Protective Cover protects the connector from weld sputter. Make sure it covers the entire connector.

Model	Material	Applicable connector
XS2Z-31	Silicone rubber/black	XS5F/XS5H/XS5W/ XS2F/XS2H/XS2W

Tools

Crimp Tool
XY2F-0002

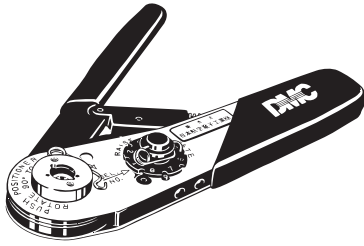

Use the Crimp Tool to crimp a cable core to the XS5U or XS2U Crimping Pin used with the XS□C or XS□G Crimping Connector.

- The XY2F-0002 Crimp Tool is DMC's AFM8 (M22520/2-01).
- Mount the XY2F-0003 Locator (sold separately) to the locator guide of the Crimp Tool with a screw provided with the XY2F-0003 Locator.

Locator
XY2F-0003

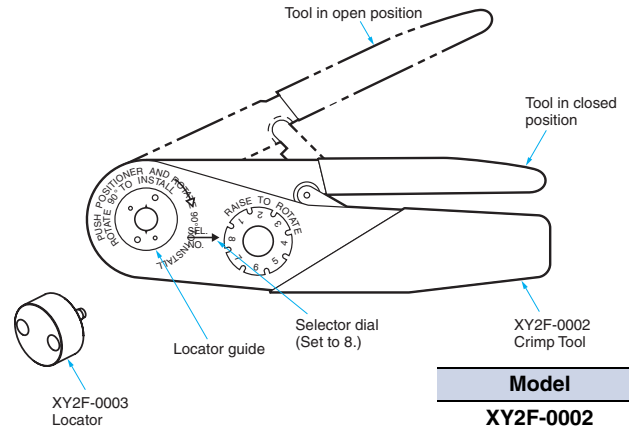

Model
XY2F-0002
XY2F-0003

Pin-block Extraction Tool
XY2F-0001

Use this tool to extract a Pin Block from the covers in order to make wiring changes or corrections after the cover has been mounted to the pin block for Connector Assemblies (XS□C/XS□G, soldering/crimping).

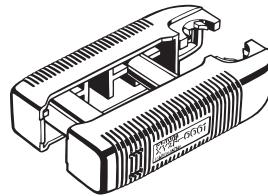

Model
XY2F-0001

Extraction Procedure

(1) Disconnecting Components

- Disconnect all components on the cap side from the cover.

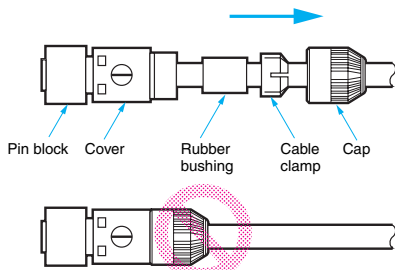

(2) Extracting Pin Block

- Insert the claws of the Tool into the four holes of the cover.

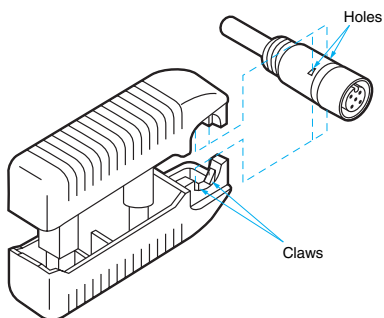

- Make sure that the pin block is outside the Tool.

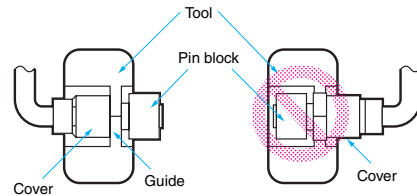

- Press the Tool so that the guides of the Tool are in close contact. Then pull the pin block straight.

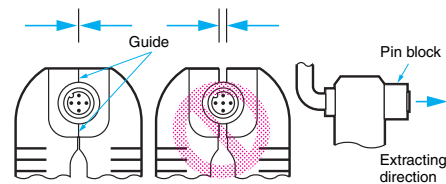

Precaution for Safe Use

- The pin block must not be extracted from the same Connector more than 3 times, otherwise the proper degree of protection of the pin block or Connector will not be maintained.

Assembly Procedure for XS5C/XS5G (IDC models) Connector Assemblies

(1) Preparations (Make sure they are all at hand.)

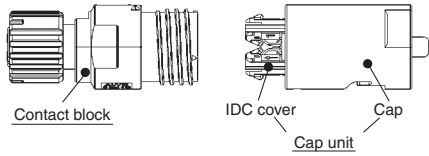

(2) Dressing the cable end

- Peel covering of a cable.

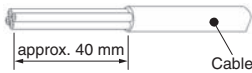

External diameter of applicable cable	Conductor cross section
3 to 8 mm	0.14 to 0.75mm ² / AWG26 to 18

(3) Choose the waterproof bushing

- Choose the waterproof bushing type according to the cable size.

<External diameter of cable: In case of 3 to 5 mm>

Use the cap unit in the delivery state.

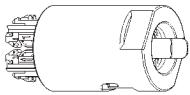

<External diameter of cable: In case of 5 to 8 mm>

When using, pick tab both sides of the waterproof bushing with a tab and pull it out in the direction of an arrow.

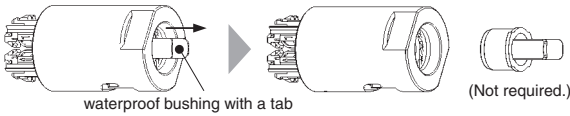

Note: When it isn't necessary to pull out bushing, do not pull a tab or pull out bushing carelessly. Do not insert the pulled-out bushing again.

(4) Cable insertion

- Insert a cable in the cap unit.

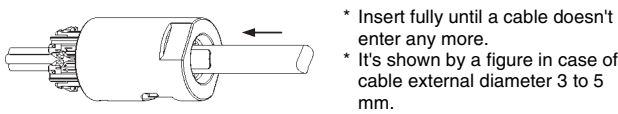

(5) Wiring

- Confirm the terminal number indication*1 of a IDC (Insulation Displacement Contact) cover, insert a core wire in each wire guide according to the terminal number and push in to the lowermost part of a core wire storage part.

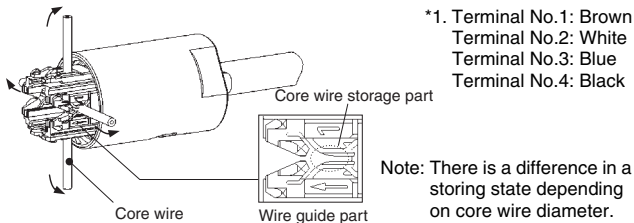

(6) Processing the core wire end

- Cut the end part of each core wire with nippers. Cutting the core wire end in the range of cut-area of figure.

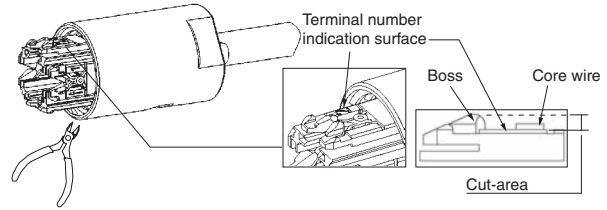

Note: Please be careful not to cut the boss.

(7) Assembling the Contact block

- Insert the cap unit core wire end processing has completed in a contact block.
- Use a Δ mark of a housing and an arrow of a IDC cover, as a guideline of alignment. The location of the arrow is the side of the terminal No.1.

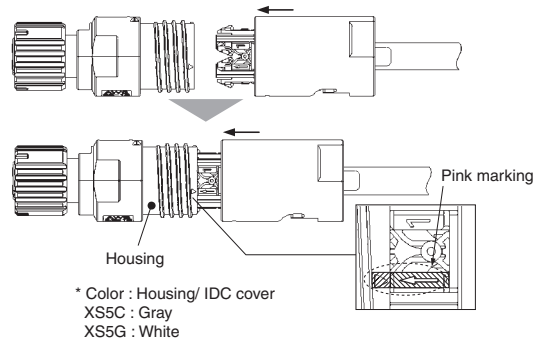

Note: Confirm that the color of the housing and the IDC cover is same before insertion.

(8) Tightening up the cap

- After inserting the cap unit and tightening a screw up lightly by hand, screw up the cap by a tool of a spanner or wrench (size 15 mm).*2

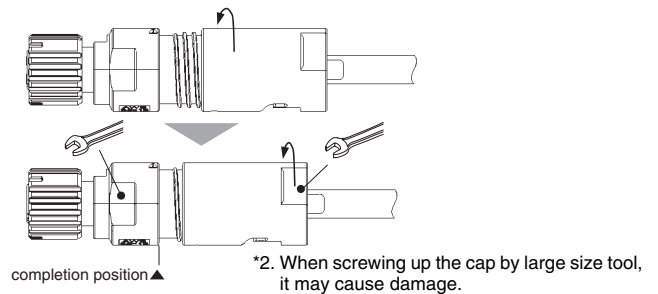

- When a gap between a mold cover of contact block and a cap disappeared assembly and wire connection has completed.

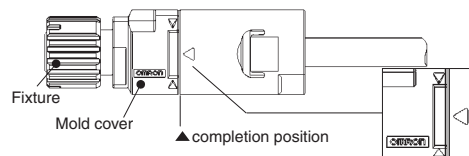

Note 1. When the operation has completed, Δ mark of cap comes into the square of the indicator formed into a mold cover ($\triangleright \square \triangleleft$), so also use it as guideline to know to complete.

2. Avoid tightening a cap up beyond the completion position. It may cause damage.

(9) Final checking

- When the connector has been assembled, make sure the line insulation is as specified.

Repair work procedure

Cap unit removal

- When releasing wire connection, remove the cap unit in the opposite procedure of assembly work. [from (8) to (7)]

Note 1. The core wire remain connected to the IDC connection part rarely. In that case, remove core wire end part to the vertical direction by tweezers etc. Do not touch the IDC contact directly at that time.

2. When IDC cover was left on the housing side, remove it by pulling a cable. In case IDC cover has been removed by holding strongly and pulling, it may cause damage.

Cable removal

- When removing the cable from the cap unit, pull the cable to the opposite direction of assembly work procedure (4). When tip of the core wire end has been pushed lightly into the IDC cover by tweezers etc, cable removal becomes easy.

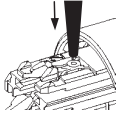

Repair work

- When connecting the wire again, do assembly (repair work) according to assembling procedure from (1) to (8).

Note 1. In case of repair, use a cable of the same diameter and a core wire of the same diameter. The number of times of repair wire connection is maximum 10 times.

2. When doing a repair, work after enough removing the foreign substance and moisture adhering to a connector. Be careful so that the foreign substance and moisture do not enter the wire connection part. It may cause short-circuit etc.

Assembly Procedure for XS5C/XS5G (Crimping/Soldering/Screw-on models) Connector Assemblies

(1) Connector and Cable External Diameters

- Connectors for 8, 7, 6, 4, and 3 mm diameter Cables (i.e., Cables that are 7 to 8, 6 to 7, 5 to 6, 4 to 5, and 3 to 4 mm in diameter respectively) are available. When assembling a Connector used with a cable, make sure that the external diameter of the Connector is suited to that of the cable.
- A watertight bushing for 6/7 mm diameter Cable has no stripe, that for 8/4 mm diameter Cable has a single stripe, and that for 3 mm diameter Cable has two stripes.

(2) Component Insertion

Crimping/Soldering Connectors

Straight Connectors

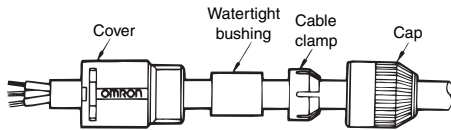

Angled Connectors

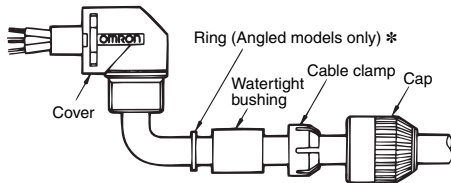

* A ring is not required for Screw-on Connectors.

- As shown in the above illustration, connect the above components to the Cable with its end processed.

Screw-on Connectors

Confirm that you have all of the required parts.

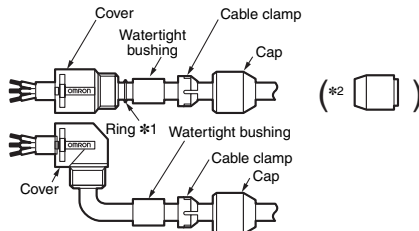

Insulation caps and insulation tubes are included with five-pole Connectors (XS2C-D5S□ and XS2G-D5S□).

- *1. Rings are not required with 7-mm and 8-mm cables.
- *2. Insert the waterproof bushing for 7-mm and 8-mm cables in the direction shown in the diagram.

(3) Wiring (Processing Cable Ends)

Soldering Connectors

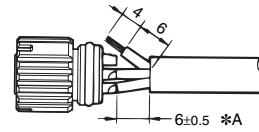

- Strip 10 mm of the Cable sheath and 4 mm of each core.
- Before soldering cores and solder cup pins together, solder-coat each of them.
- The following conditions are recommended for soldering each solder cup pin.
Soldering temperature: 350±5°C
Soldering period: 3±1 s
- The length marked *A should be 6.5 mm max., otherwise the proper degree of protection of the connector will not be maintained.

Crimping Connectors

Crimping

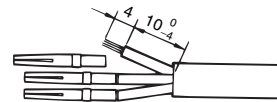

- Strip 14 mm of the Cable sheath and 4 mm of each core.
- Make sure that each core is not damaged and its end strands are not spread out.
- Mount the XY2F-0003 Locator to XY2F-0002 Crimping Tool, both of which are sold separately, and set the selector dial of the Crimping Tool to 8.
- After mounting the crimping pins to the Locator, fully insert the cores to the crimping pins.
- Squeeze the handle of the Crimp Tool to press-fit the cores to the crimping pins.
(Squeeze the handle firmly until the handle automatically returns to the release position.)

Wiring

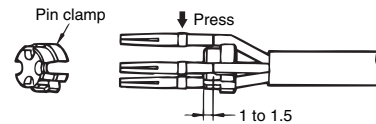

- After press-fitting the cores to the pins, insert the pins into the pin clamp as shown in the illustration. Then make sure that the lead colors correspond to the pin clamp numbers that are identical to the connector pin numbers.

Insertion

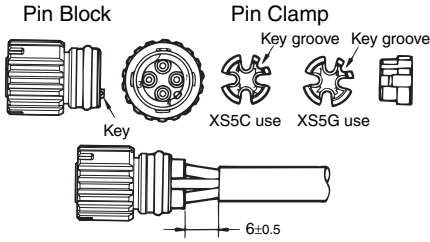

- Tentatively insert the pins to the pin block holes so that the key on the pin block will coincide with the key groove on the pin clamp. Then insert the cable along with the pin clamp.

Screw-on Connectors

Cable End Processing

• Four-pole Connectors

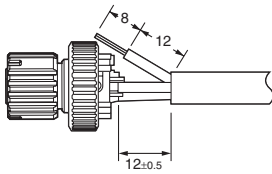

- Loosen the screws on pins 1 to 4 and insert the cores according to the pin numbers.

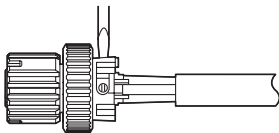

- Use the dedicated Screwdriver (XW4Z-00B)* and tighten the screws securely so that the cores do not pull out (tightening torque: 0.15 to 0.2 N·m).

• Five-pole Connectors

- Strip the cable sheath for a total of 15 mm and strip the core covering for 8 mm for the core to connect to pin 5.

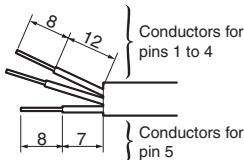

- Connect the core to pin 5 (in the center) first.
- Insert the core from the side of the hold with the tab and tighten the screw securely (tightening torque: Pins 1 to 4: 0.15 to 0.2 N·m, Pins 5: 0.03 to 0.05 N·m), and then cut off the excess wire with wire cutters.

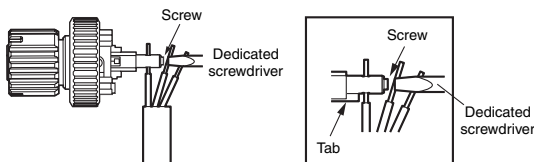

- Bend the cable as shown below, attached the enclosed insulation cap, and then strip the other cores.

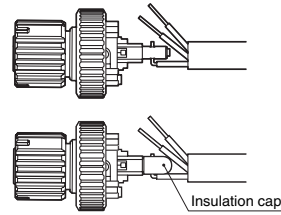

- Connect the cores to pins 1 to 4.

Connecting Shielded Cables to Five-pole Connectors

- Place the insulation tub on the drain line of the shield and connect it to the terminal.
- Tighten the screw and then check visually to see if there is insulation between the cores.

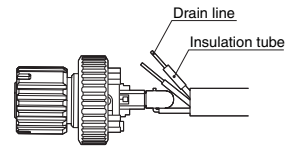

- Connect the cores to pins 1 to 4.

* When tightening the screws, use the dedicated XW4Z-00B Screwdriver that matches with the screw-slot dimensions.

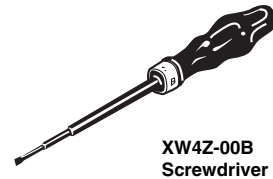

(4) Inserting Pin Block

Pin Block (Soldering Model)

Cover (Straight Model)

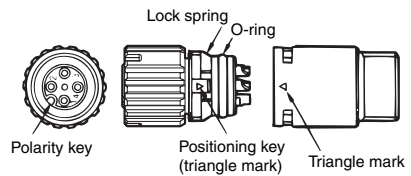

(Crimping Model)

(Angled Model)

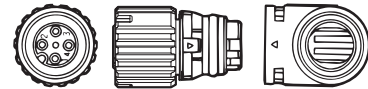

- Mount the cover to the pin block so that the triangle mark on the pin block will coincide with the triangle mark on the cover.
- If the cover is used for an Angled model, the relationship between the position of the polarity key on the engaged side and cable connection direction will be determined by the direction in which the positioning key is inserted into the cover, which can be rotated by 90°.
- Fully insert the positioning key until the positioning key is hidden by the casing.

**Pin Block
(Screw-on Connectors)**

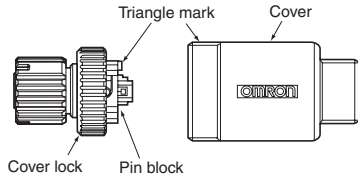

- Align the triangular marks on the pin block and cover and insert the pin block into the cover.
- Press them together firmly (0.39 to 0.49 N·m) until the pin block does not come out of the cover.

(5) Mounting Cap

- After mounting the cover to the pin block and the cover snaps into place, tighten the cap securely by hand within a torque of 0.39 and 0.49 N·m.

Note: If the cap is not tighten securely enough, the degree of protection (IP67) may not be maintained or vibration may cause the cap to become loose. Do not tighten the cap with pliers or similar tools; they may damage the cap.

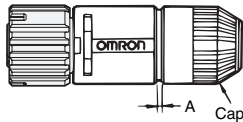

- After fully tightening the cap, length A should be approximately one of the following according to the cable external diameter and the Connector model.

Connector	Cable external diameter (mm)			
	6 mm	5 mm	4 mm	3 mm
For 6-mm-dia. cable	1	0	---	---
For 4-mm-dia. cable	---	2	1	---
For 3-mm-dia. cable	---	---	2	1

(6) After Assembly

- Confirm the insulation between cores after completing assembly.

Recommended Cables

When connecting a commercially available cable to a connector assembly, use a cable with an outside diameter of 3 to 6 mm and core sizes of 0.18 to 0.75 mm² for crimping connectors and 0.5 mm² maximum for soldering connectors.

Connector Arrangement

For safety, when constructing a connection system between a Sensor and panel with a connector, make sure that the connector plug is on the Sensor side and the connector socket is on the panel side (i.e., the female pins are located on the power-supply side).

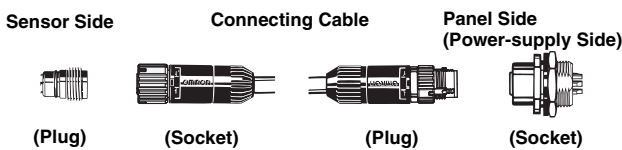

Connecting the XS5

1. Connecting the XS5 Plug and Socket

- Align the projection on the plug cover with the polarity key on the socket, then insert the plug all the way in.



- Hold the knurled socket grip, then insert the projection on the plug into the groove of the socket.



- Turn the knurled grips of the socket clockwise approximately 45 degrees in respect to the plug. A click will indicate that the Connectors are locked. The locking condition can also be confirmed by the alignment marks on the plug and socket.

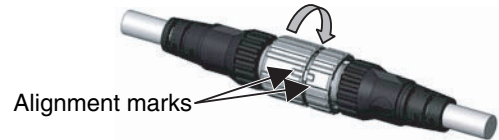

2. Connecting the XS5 and XS2

- Align the projection on the plug cover with the polarity key on the socket, then insert the plug all the way in.
- In the same way as when connecting two XS2 Connectors, screw the knurled grip in the clockwise direction.
- Use your fingers to tighten the Connectors sufficiently.

Safety Precautions

Precautions for Correct Use

Do not use the Connectors in an atmosphere or environment that exceeds the specifications.

Connector Connection and Disconnection

- When connecting or disconnecting Connectors, be sure to hold the Connectors by hand.
- Do not hold the cable when disconnecting Connectors.
- When mating Connectors, be sure to insert the plug all the way to the back of the socket before attempting to lock the Connectors.
- Do not use tools of any sort to mate the Connectors. Always use your hands. Pliers or other tools may damage the Connectors.
- When mating the Connectors to XS2 or other M12 Connectors, tighten the lock by hand to a torque of 0.39 to 0.49 N·m.

Wiring

- Always confirm wiring diagrams before wiring sensors, limit switches, or other devices.
- Lay the cables so that external force is not applied to the Connectors. Otherwise, the degree of protection (IP67) may not be achieved.

Degree of Protection

- The degree of protection of Connectors (IP67) is not for a fully watertight structure. Do not use the Connectors underwater.
- Do not step on or place any objects on the Connectors. Doing so may damage the Connectors.

General Precautions

- Do not pull excessively on the Connectors or cables. Do not install the Connectors or cables in any way that would place a load directly on the mating section or cable connections. Doing so can damage the Connectors or break the wires inside the cables.
- Install the Connectors and cables where they will not be stepped on to prevent the wires inside the cables from being broken and to prevent the Connectors from being damaged. If the Connectors or cables must be installed where they might be stepped on, protect them with covers.
- Refer to the specifications for your cables before bending the cables and do not bend them past their minimum bending radius.
- If sensors or switches are not attached during installation, protect the mating surface of the Connector with a XS5Z-11 Waterproof Cover or XS2Z-14/15 Dust Cover.

Setup

- Do not make any cable bends near the base of the Unit.
- Any bends made must have a minimum radius of 40 mm.

Terms and Conditions Agreement

Read and understand this catalog.

Please read and understand this catalog before purchasing the products. Please consult your OMRON representative if you have any questions or comments.

Warranties.

(a) Exclusive Warranty. Omron's exclusive warranty is that the Products will be free from defects in materials and workmanship for a period of twelve months from the date of sale by Omron (or such other period expressed in writing by Omron). Omron disclaims all other warranties, express or implied.

(b) Limitations. OMRON MAKES NO WARRANTY OR REPRESENTATION, EXPRESS OR IMPLIED, ABOUT NON-INFRINGEMENT, MERCHANTABILITY OR FITNESS FOR A PARTICULAR PURPOSE OF THE PRODUCTS. BUYER ACKNOWLEDGES THAT IT ALONE HAS DETERMINED THAT THE PRODUCTS WILL SUITABLY MEET THE REQUIREMENTS OF THEIR INTENDED USE.

Omron further disclaims all warranties and responsibility of any type for claims or expenses based on infringement by the Products or otherwise of any intellectual property right. (c) Buyer Remedy. Omron's sole obligation hereunder shall be, at Omron's election, to (i) replace (in the form originally shipped with Buyer responsible for labor charges for removal or replacement thereof) the non-complying Product, (ii) repair the non-complying Product, or (iii) repay or credit Buyer an amount equal to the purchase price of the non-complying Product; provided that in no event shall Omron be responsible for warranty, repair, indemnity or any other claims or expenses regarding the Products unless Omron's analysis confirms that the Products were properly handled, stored, installed and maintained and not subject to contamination, abuse, misuse or inappropriate modification. Return of any Products by Buyer must be approved in writing by Omron before shipment. Omron Companies shall not be liable for the suitability or unsuitability or the results from the use of Products in combination with any electrical or electronic components, circuits, system assemblies or any other materials or substances or environments. Any advice, recommendations or information given orally or in writing, are not to be construed as an amendment or addition to the above warranty.

See <http://www.omron.com/global/> or contact your Omron representative for published information.

Limitation on Liability; Etc.

OMRON COMPANIES SHALL NOT BE LIABLE FOR SPECIAL, INDIRECT, INCIDENTAL, OR CONSEQUENTIAL DAMAGES, LOSS OF PROFITS OR PRODUCTION OR COMMERCIAL LOSS IN ANY WAY CONNECTED WITH THE PRODUCTS, WHETHER SUCH CLAIM IS BASED IN CONTRACT, WARRANTY, NEGLIGENCE OR STRICT LIABILITY.

Further, in no event shall liability of Omron Companies exceed the individual price of the Product on which liability is asserted.

Suitability of Use.

Omron Companies shall not be responsible for conformity with any standards, codes or regulations which apply to the combination of the Product in the Buyer's application or use of the Product. At Buyer's request, Omron will provide applicable third party certification documents identifying ratings and limitations of use which apply to the Product. This information by itself is not sufficient for a complete determination of the suitability of the Product in combination with the end product, machine, system, or other application or use. Buyer shall be solely responsible for determining appropriateness of the particular Product with respect to Buyer's application, product or system. Buyer shall take application responsibility in all cases.

NEVER USE THE PRODUCT FOR AN APPLICATION INVOLVING SERIOUS RISK TO LIFE OR PROPERTY OR IN LARGE QUANTITIES WITHOUT ENSURING THAT THE SYSTEM AS A WHOLE HAS BEEN DESIGNED TO ADDRESS THE RISKS, AND THAT THE OMRON PRODUCT(S) IS PROPERLY RATED AND INSTALLED FOR THE INTENDED USE WITHIN THE OVERALL EQUIPMENT OR SYSTEM.

Programmable Products.

Omron Companies shall not be responsible for the user's programming of a programmable Product, or any consequence thereof.

Performance Data.

Data presented in Omron Company websites, catalogs and other materials is provided as a guide for the user in determining suitability and does not constitute a warranty. It may represent the result of Omron's test conditions, and the user must correlate it to actual application requirements. Actual performance is subject to the Omron's Warranty and Limitations of Liability.

Change in Specifications.

Product specifications and accessories may be changed at any time based on improvements and other reasons. It is our practice to change part numbers when published ratings or features are changed, or when significant construction changes are made. However, some specifications of the Product may be changed without any notice. When in doubt, special part numbers may be assigned to fix or establish key specifications for your application. Please consult with your Omron's representative at any time to confirm actual specifications of purchased Product.

Errors and Omissions.

Information presented by Omron Companies has been checked and is believed to be accurate; however, no responsibility is assumed for clerical, typographical or proofreading errors or omissions.

2014.9

In the interest of product improvement, specifications are subject to change without notice.

OMRON Corporation
Industrial Automation Company

<http://www.ia.omron.com/>

(c)Copyright OMRON Corporation 2014 All Right Reserved.

Mouser Electronics

Authorized Distributor

Click to View Pricing, Inventory, Delivery & Lifecycle Information:

Omron:

[XS5F-D421-C80-F](#) [XS5F-D421-D80-F](#) [XS5F-D421-D80-P](#) [XS5F-D421-E80-F](#) [XS5F-D421-G80-F](#) [XS5F-D421-G80-P](#) [XS5F-D421-J80-F](#) [XS5F-D421-J80-P](#) [XS5H-D421-A80-P](#) [XS5H-D421-C80-F](#) [XS5H-D421-D80-F](#) [XS5H-D421-D80-P](#) [XS5H-D421-G80-F](#) [XS5H-D421-G80-P](#) [XS5R-D426-C10-F](#) [XS5R-D426-E10-F](#) [XS5W-D421-C81-F](#) [XS5W-D421-D81-F](#) [XS5W-D421-D81-P](#) [XS5W-D421-E81-F](#) [XS5W-D421-G81-F](#) [XS5W-D421-G81-P](#) [XS5W-D421-J81-F](#) [XS5W-D421-J81-P](#) [XS5R-D426-B11-F](#) [XS5R-D426-C11-F](#) [XS5R-D426-D10-F](#) [XS5R-D426-D11-F](#) [XS5R-D426-E11-F](#) [XS5R-D426-G10-F](#) [XS5G-D4S1](#) [XS5G-D421](#) [XS5C-D4S1](#) [XS5G-D4S2](#) [XS5G-D5S7](#) [XS5C-D421](#)