

Features

- Low power consumption
- Robust package
- I.C. Compatible
- Standard configuration: Gray face w/ white segments
- Optional black face provides superior color contrast
- RoHS Compliant

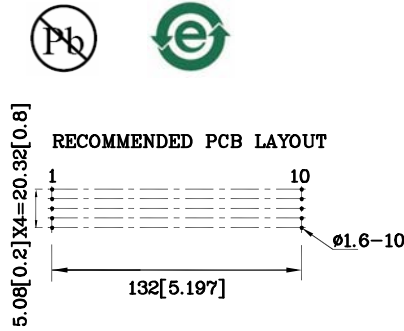

Package Schematics

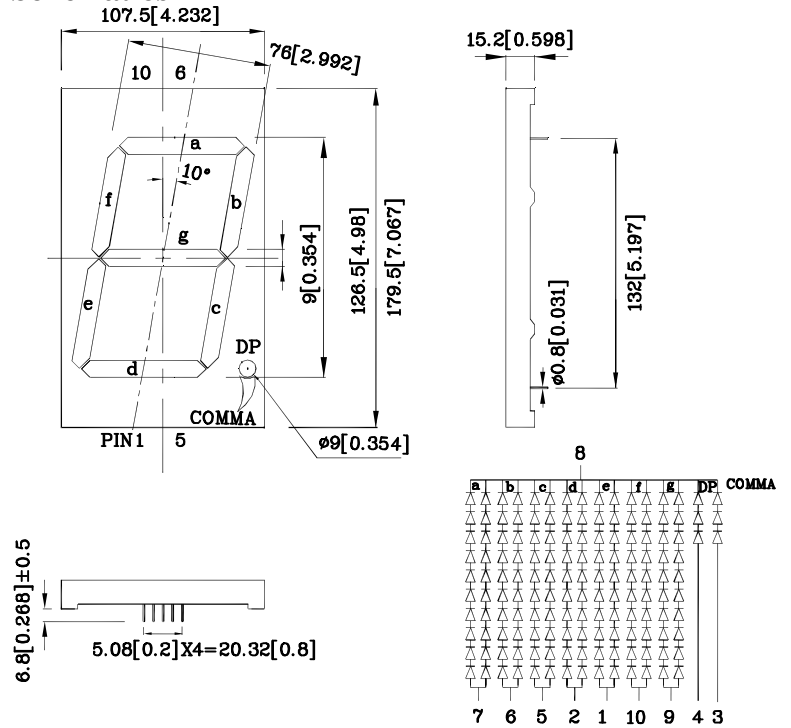

Notes:

1. All dimensions are in millimeters (inches), Tolerance is ±0.25(0.01") unless otherwise noted.
2. Specifications are subject to change without notice.

Absolute Maximum Ratings (T _A =25°C)		UR (GaAsP/ GaP)	Unit
Reverse Voltage Per Segment Or (Dp And Comma)	V _R	5 (5)	V
DC Forward Current Per Segment Or (Dp And Comma)	I _F	60 (30)	mA
Forward Current (Peak) Per Segment Or (Dp And Comma) 1/10 Duty Cycle 0.1ms Pulse Width	i _{FS}	320 (160)	mA
Power Dissipation Per Segment Or (Dp And Comma)	P _D	1500 (450)	mW
Operating Temperature	T _A	-40 ~ +85	°C
Storage Temperature	T _{stg}	-40 ~ +85	
Lead Solder Temperature [2mm Below Package Base]	260°C For 3-5 Seconds		

Operating Characteristics (T _A =25°C)		UR (GaAsP/ GaP)	Unit
Forward Voltage (Typ.) (I _F =10mA) Per Segment Or (Dp And Comma)	V _F	19 (5.7)	V
Forward Voltage (Max.) (I _F =10mA) Per Segment Or (Dp And Comma)	V _F	25 (7.5)	V
Reverse Current (V _R =5V) (Max.) Per Segment Or (Dp And Comma)	I _R	10 (10)	uA
Wavelength of Peak Emission CIE127-2007* (Typ.) (I _F =10mA)	λ _P	627 627*	nm
Wavelength of Dominant Emission CIE127-2007* (Typ.) (I _F =10mA)	λ _D	625 617*	nm
Spectral Line Full Width At Half-Maximum (Typ.) (I _F =10mA)	Δλ	45	nm
Capacitance (Typ.) (V _F =0V, f=1MHz)	C	15	pF

Part Number	Emitting Color	Emitting Material	Luminous Intensity CIE127-2007* (I _F =10mA) ucd		Wavelength CIE127-2007* λ _P nm	Description
			min.	typ.		
XDUR127C-B	Red	GaAsP/GaP	21000 9000*	51990 15000*	627*	Common Cathode, Rt. Hand Decimal.

*Luminous intensity value and wavelength are in accordance with CIE127-2007 standards.
Jul 10, 2012

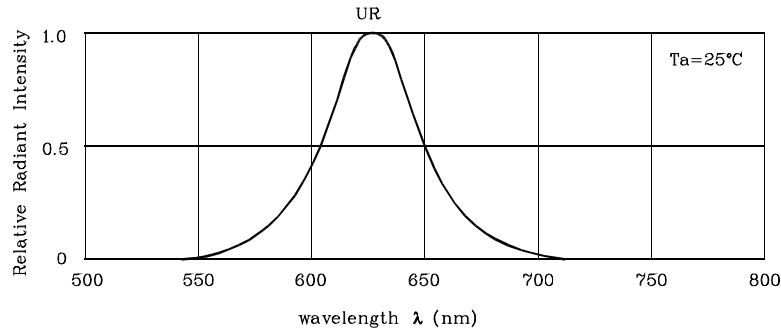

RELATIVE INTENSITY Vs. CIE WAVELENGTH

❖ UR

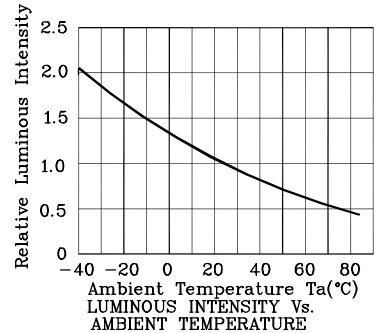
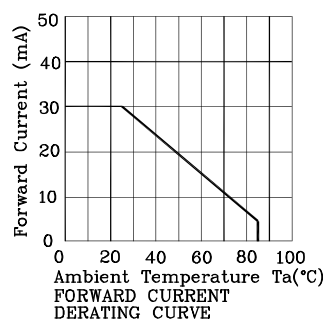
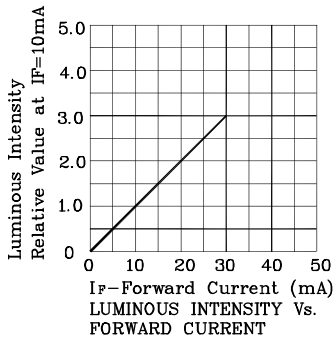
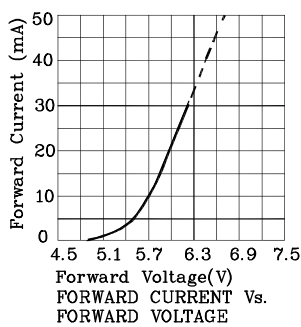
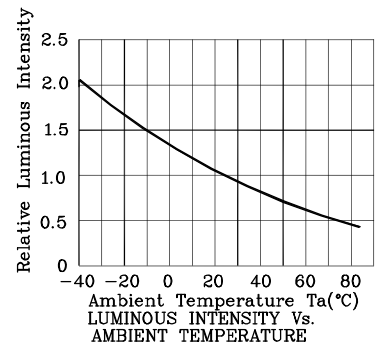
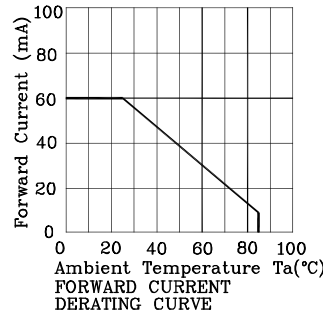
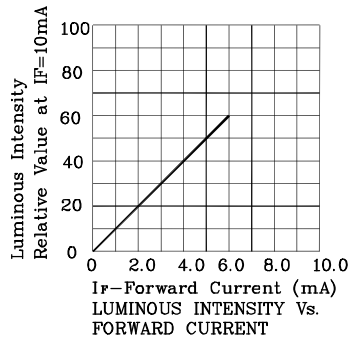
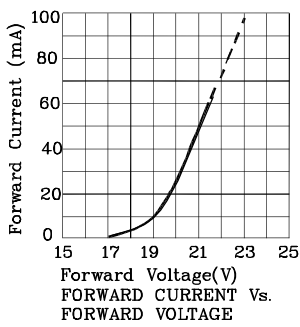

Wave Soldering Profile for Thru-Hole Products (Pb-Free Components)

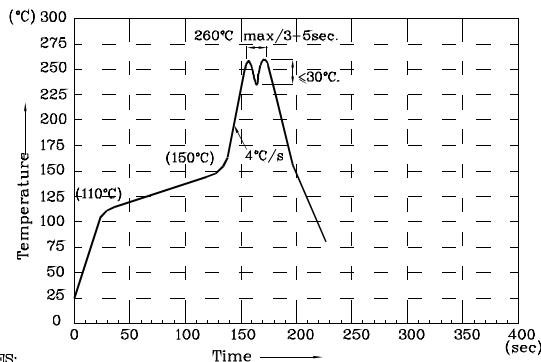

NOTES:

1. Recommend the wave temperature 245°C~260°C. The maximum soldering temperature should be less than 260°C.
2. Do not apply stress on epoxy resins when temperature is over 85°C.
3. The soldering profile apply to the lead free soldering (Sn/Cu/Ag alloy).
4. During wave soldering, the PCB top-surface temperature should be kept below 105°C.
5. No more than once.

Remarks:

If special sorting is required (e.g. binning based on forward voltage, luminous intensity / luminous flux, or wavelength), the typical accuracy of the sorting process is as follows:

1. Wavelength: +/-1nm
2. Luminous Intensity / Luminous Flux: +/-15%
3. Forward Voltage: +/-0.1V

Note: Accuracy may depend on the sorting parameters.

PACKING & LABEL SPECIFICATIONS

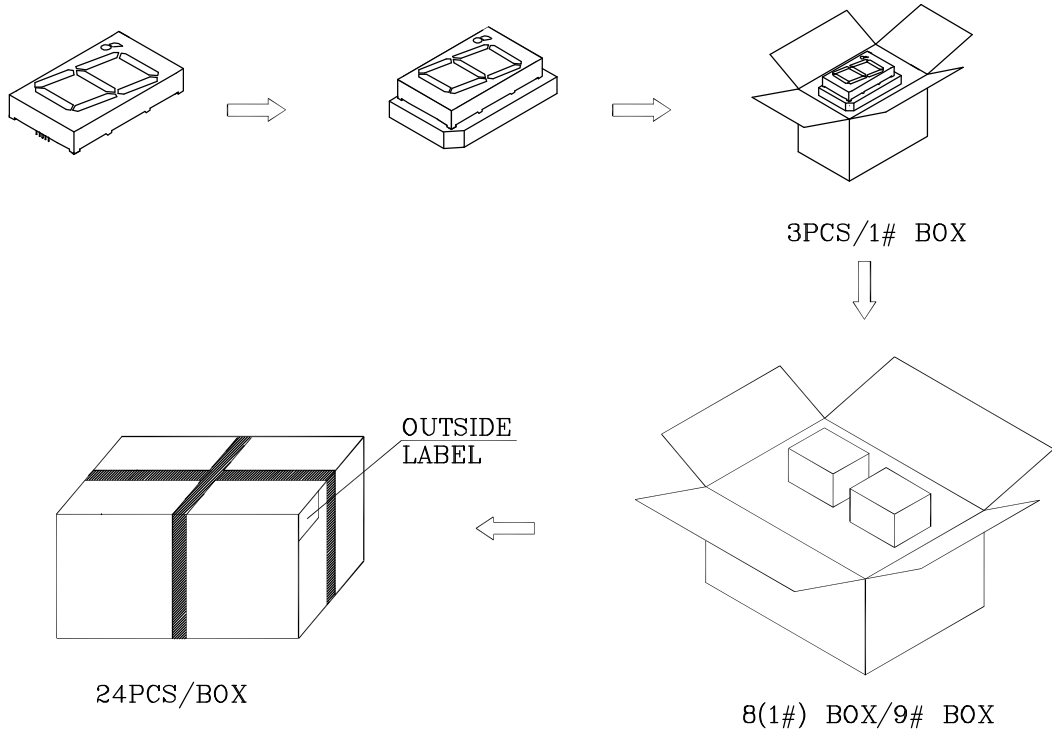

Inside Label On 1#BOX

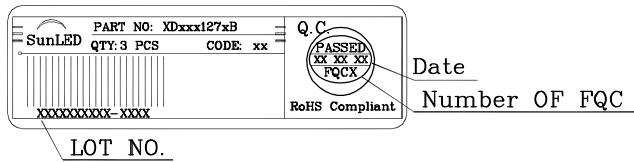

Outside Label On Box

