

Features

- Low power consumption
- Robust package
- I.C. Compatible
- Standard configuration: Gray face w/ white segments
- Optional black face provides superior color contrast
- RoHS Compliant

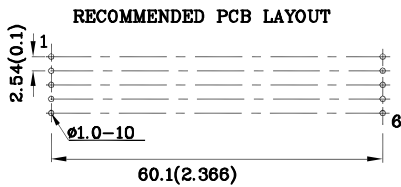

Package Schematics

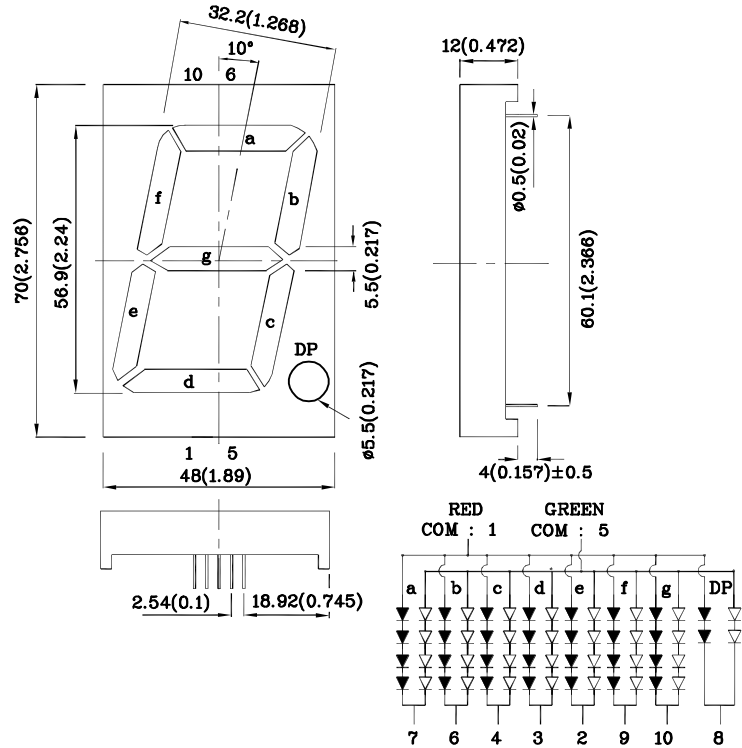

Notes:

1. All dimensions are in millimeters (inches), Tolerance is $\pm 0.25(0.01)$ unless otherwise noted.
2. Specifications are subject to change without notice.

Absolute Maximum Ratings ($T_A=25^\circ\text{C}$)		UR (GaAsP/GaP)	UG (GaP)	Unit
Reverse Voltage Per Segment Or (DP)	V_R	5	5	V
Forward Current Per Segment Or (DP)	I_F	30	25	mA
Forward Current (peak) Per Segment Or (DP) 1/10Duty Cycle 0.1ms Pulse Width	i_{FS}	160	140	mA
Power Dissipation Per Segment Or (DP)	P_D	300 (150)	250 (125)	mW
Operating Temperature	T_A	-40 ~ +85		°C
Storage Temperature	T_{stg}	-40 ~ +85		
Lead Solder Temperature [2mm Below Package Base]	260°C For 3-5 Seconds			

Operating Characteristics ($T_A=25^\circ\text{C}$)		UR (GaAsP/GaP)	UG (GaP)	Unit
Forward Voltage (Typ.) Per Segment Or (DP) ($I_F=10\text{mA}$)	V_F	7.6 (3.8)	8 (4.0)	V
Forward Voltage (Max.) Per Segment Or (DP) ($I_F=10\text{mA}$)	V_F	10 (5.0)	10 (5.0)	V
Reverse Current Per Segment Or (DP) ($V_R=5\text{V}$)	I_R	10	10	μA
Wavelength of Peak Emission (Typ.) ($I_F=10\text{mA}$)	λ_P	627	565	nm
Wavelength of Dominant Emission (Typ.) ($I_F=10\text{mA}$)	λ_D	625	568	nm
Spectral Line Full Width At Half-Maximum (Typ.) ($I_F=10\text{mA}$)	$\Delta\lambda$	45	30	nm
Capacitance (Typ.) ($V_F=0\text{V}$, $f=1\text{MHz}$)	C	15	15	pF

Part Number	Emitting Color	Emitting Material	Luminous Intensity ($I_F=10\text{mA}$) ucd		Wavelength nm λ_P	Description
			min.	typ.		
XDURG57A-A	Red	GaAsP/GaP	31000	56990	627	Common Anode, Rt.Hand Decimal.
	Green	GaP	31000	64990	565	

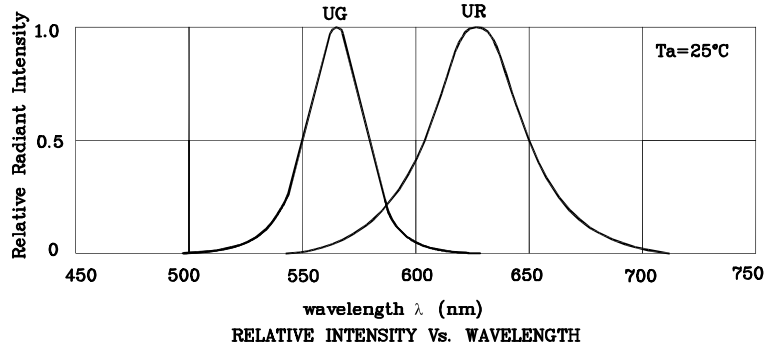

❖ UR

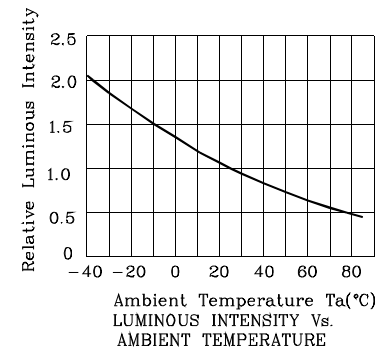
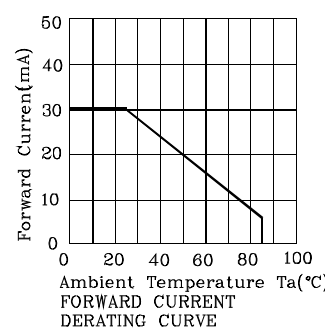
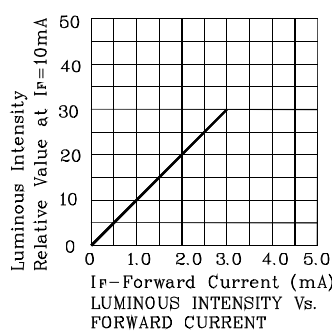
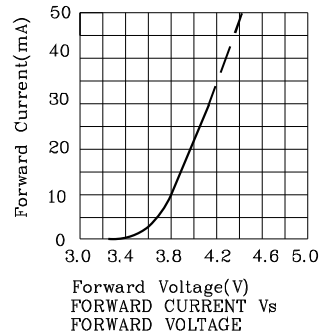
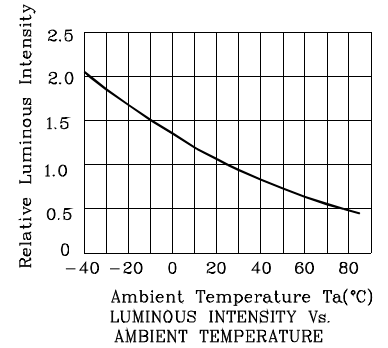
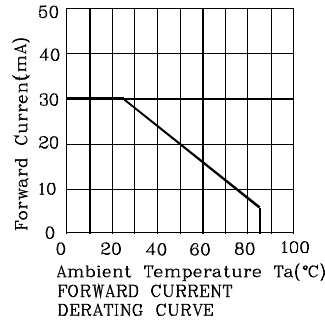
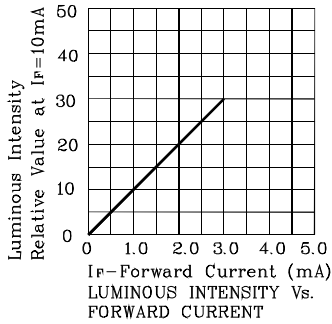
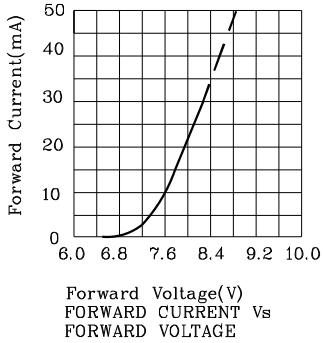

❖ UG

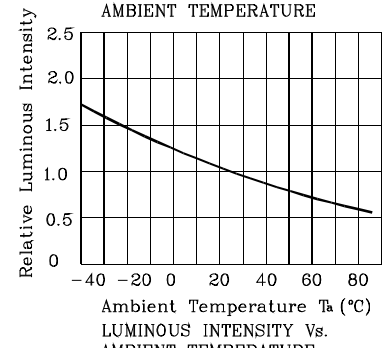
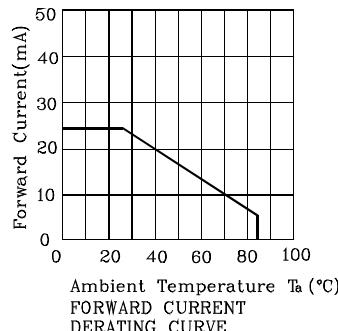
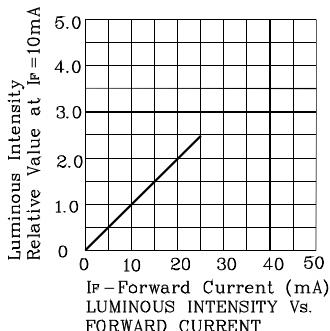
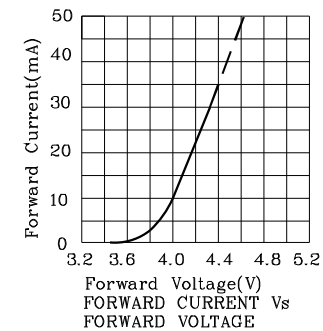
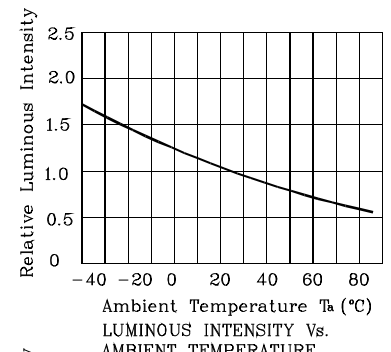
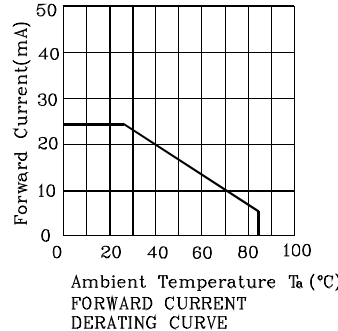
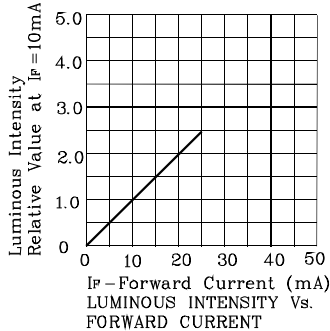
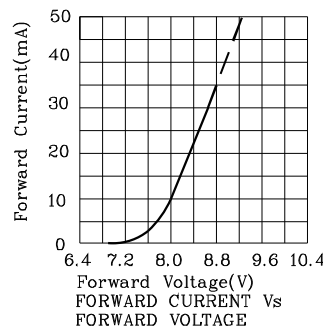

Wave Soldering Profile for Thru-Hole Products (Pb-Free Components)

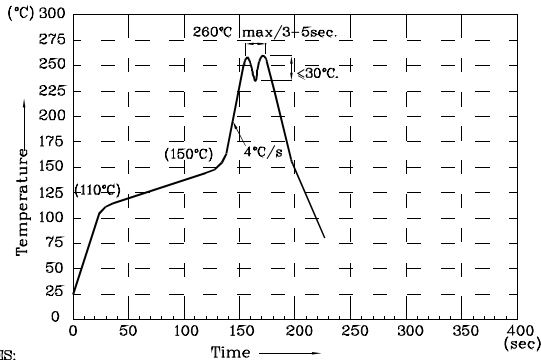

- NOTES:
1. Recommend the wave temperature 245°C~260°C. The maximum soldering temperature should be less than 260°C.
 2. Do not apply stress on epoxy resins when temperature is over 85°C.
 3. The soldering profile apply to the lead free soldering (Sn/Cu/Ag alloy).
 4. During wave soldering, the PCB top-surface temperature should be kept below 105°C.
 5. No more than once.

Remarks:
If special sorting is required (e.g. binning based on forward voltage, luminous intensity / luminous flux, or wavelength), the typical accuracy of the sorting process is as follows:

1. Wavelength: +/-1nm
2. Luminous Intensity / Luminous Flux: +/-15%
3. Forward Voltage: +/-0.1V

Note: Accuracy may depend on the sorting parameters.

PACKING & LABEL SPECIFICATIONS

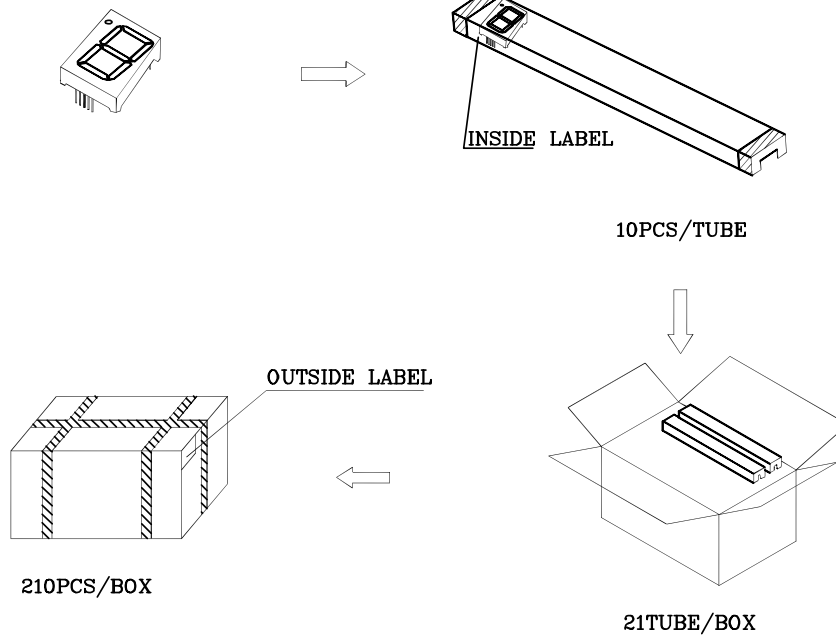

Inside Label On IC-tube

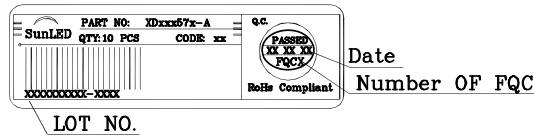

Outside Label On Box

