

**Features**

- Low power consumption
- Robust package
- I.C. Compatible
- Standard configuration: Gray face w/ white segments
- Optional black face provides superior color contrast
- RoHS Compliant

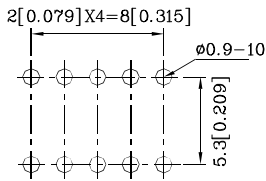

RECOMMENDED PCB LAYOUT



**Package Schematics**

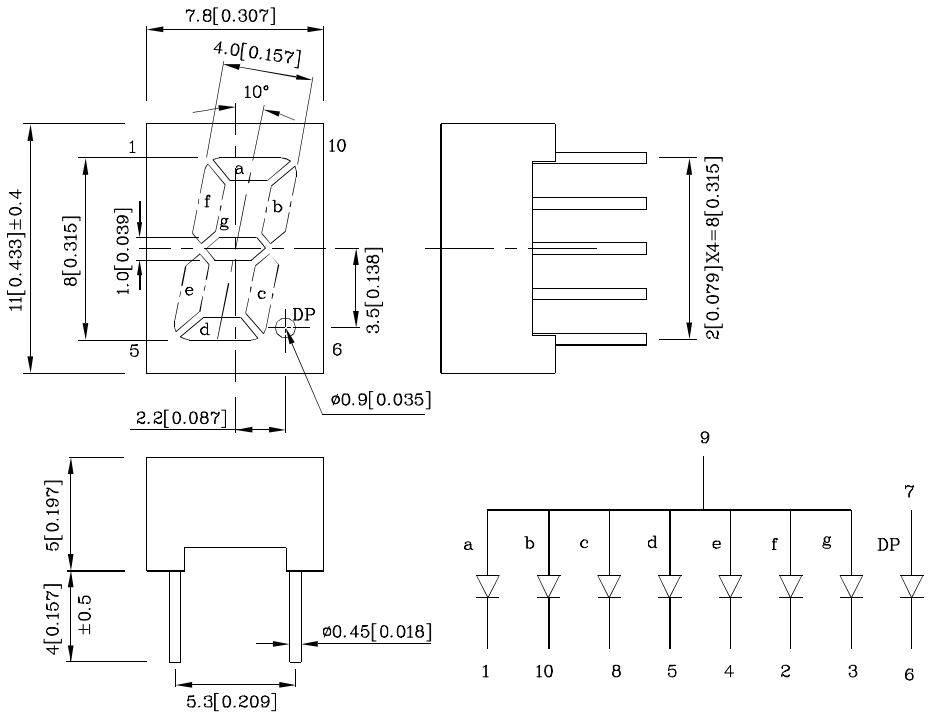

Notes:

1. All dimensions are in millimeters (inches), Tolerance is ±0.25(0.01") unless otherwise noted.
2. Specifications are subject to change without notice.

Absolute Maximum Ratings (T <sub>A</sub> =25°C)		UY (GaAsP/GaP)	Unit
Reverse Voltage	V <sub>R</sub>	5	V
Forward Current	I <sub>F</sub>	30	mA
Forward Current (Peak) 1/10 Duty Cycle 0.1ms Pulse Width	i <sub>FS</sub>	140	mA
Power Dissipation	P <sub>D</sub>	75	mW
Operating Temperature	T <sub>A</sub>	-40 ~ +85	°C
Storage Temperature	T <sub>stg</sub>	-40 ~ +85	
Lead Solder Temperature [2mm Below Package Base]	260°C For 3-5 Seconds		

Operating Characteristics (T <sub>A</sub> =25°C)		UY (GaAsP/GaP)	Unit
Forward Voltage (Typ.) (I <sub>F</sub> =10mA)	V <sub>F</sub>	1.95	V
Forward Voltage (Max.) (I <sub>F</sub> =10mA)	V <sub>F</sub>	2.5	V
Reverse Current (Max.) (V <sub>R</sub> =5V)	I <sub>R</sub>	10	uA
Wavelength of Peak Emission (Typ.) (I <sub>F</sub> =10mA)	λ <sub>P</sub>	590	nm
Wavelength of Dominant Emission (Typ.) (I <sub>F</sub> =10mA)	λ <sub>D</sub>	588	nm
Spectral Line Full Width At Half-Maximum (Typ.) (I <sub>F</sub> =10mA)	Δλ	35	nm
Capacitance (Typ.) (V <sub>F</sub> =0V, f=1MHz)	C	20	pF

Part Number	Emitting Color	Emitting Material	Luminous Intensity (I <sub>F</sub> =10mA) ucd		Wavelength nm λ <sub>P</sub>	Description
			min.	typ.		
XDUY06A-1	Yellow	GaAsP/GaP	3600	6890	590	Common Anode, Rt. Hand Decimal.

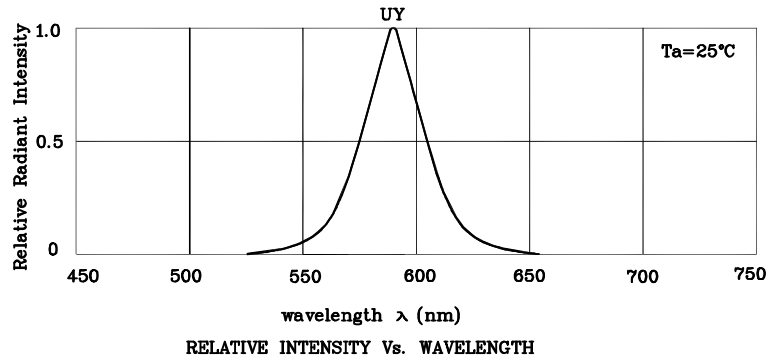

❖ UY

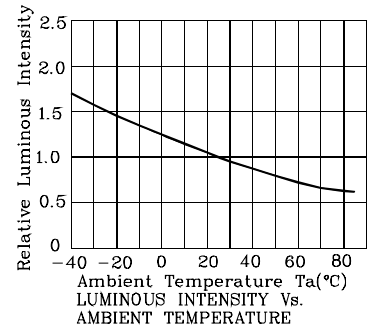
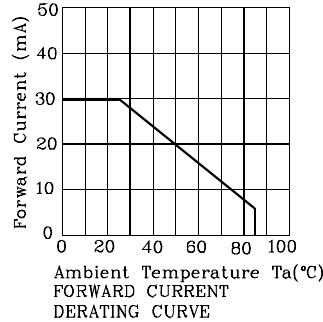
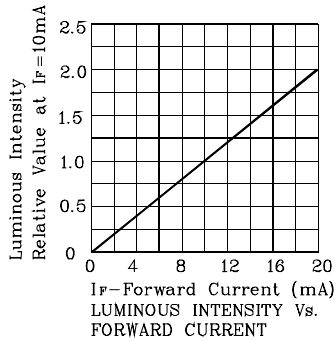
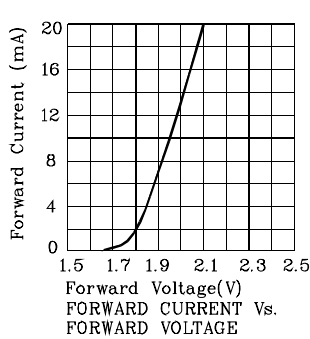

Wave Soldering Profile for Thru-Hole Products (Pb-Free Components)

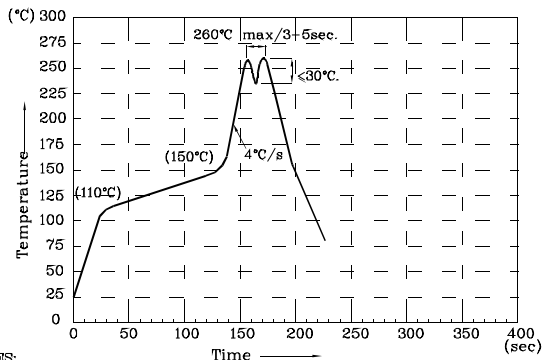

NOTES:

1. Recommend the wave temperature 245°C~260°C. The maximum soldering temperature should be less than 260°C.
2. Do not apply stress on epoxy resins when temperature is over 85°C.
3. The soldering profile apply to the lead free soldering (Sn/Cu/Ag alloy).
4. During wave soldering, the PCB top-surface temperature should be kept below 105°C.
5. No more than once.

Remarks:

If special sorting is required (e.g. binning based on forward voltage, luminous intensity / luminous flux, or wavelength), the typical accuracy of the sorting process is as follows:

1. Wavelength: +/-1nm
2. Luminous Intensity / Luminous Flux: +/-15%
3. Forward Voltage: +/-0.1V

Note: Accuracy may depend on the sorting parameters.

PACKING & LABEL SPECIFICATIONS

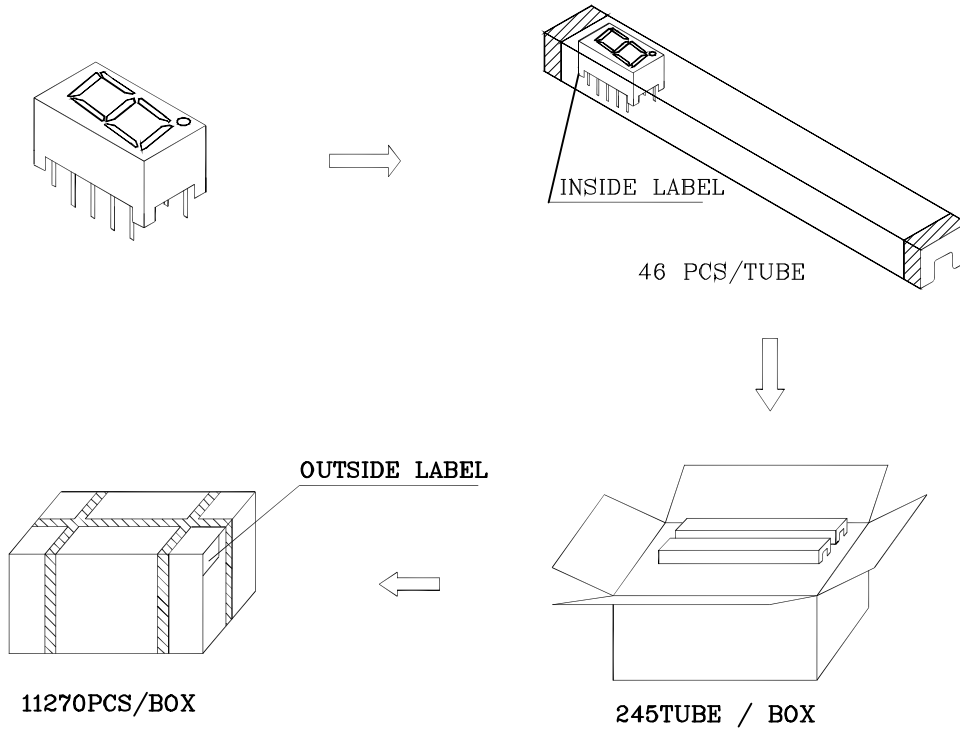

Inside Label On IC-tube

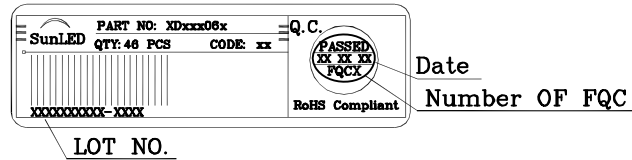

Outside Label On Box

