



# MODEL 276 SERIES Current Transformers

- 25 to 400Hz
- 0 to 5 Amp Secondary
- Wide Application Range
- Agency Approved

## DESCRIPTION

**Model 276A Current Transformer** - A low cost, open-frame type current transformer (CT). For use with up to 8 gauge wire, and up to 40 amps on the primary. 2500 VRMS insulation is standard. Frequency range is 25-400Hz. The Model 276A CT is CSA Certified.

**Model 276B Current Transformer** - A ring-type current transformer for currents from 50 to 1200 amps. The Model 276B has an accuracy rating of  $\pm 2\%$  for 50-100 amp CT's and  $\pm 1\%$  over 100 amps at 60Hz.

This CT also features a 25-400Hz frequency range, #8-32 secondary terminals and mounting brackets. Polarity markings are stamped on the CT. The Model 276B is UL Recognized and CSA Certified.



## SPECIFICATIONS

Ratio	Part No.	Ratio	Part No.	Burden	Ratio	Part No.	Burden
		50:5	276B-50	1.0	300:5	276B-300	12.5
10:5	276A-10	60:5	276B-60	1.0	400:5	276B-400	12.5
15:5	276A-15	75:5	276B-75	1.5	500:5	276B-500	25.0
20:5	276A-20	80:5	276B-80	1.5	600:5	276B-600	15.0
25:5	276A-25	100:5	276B-100	2.0	750:5	276B-750	7.0
30:5	276A-30	150:5	276B-150	5.0	800:5	276B-800	8.0
35:5	276A-35	200:5	276B-200	5.0	1000:5	276B-1000	10.0
40:5	276A-40	250:5	276B-250	12.5	1200:5	276B-1200	12.5

Burden VA @ 60Hz

## 276A APPLICATION DIAGRAM

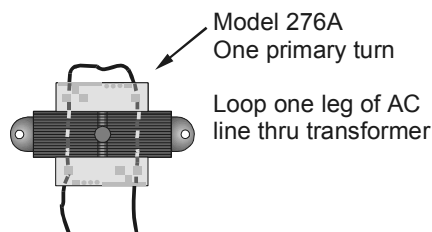

## 276A DIMENSIONS

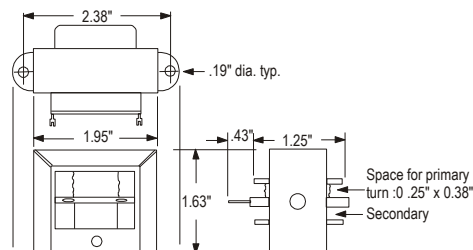

## 276B APPLICATION DIAGRAM

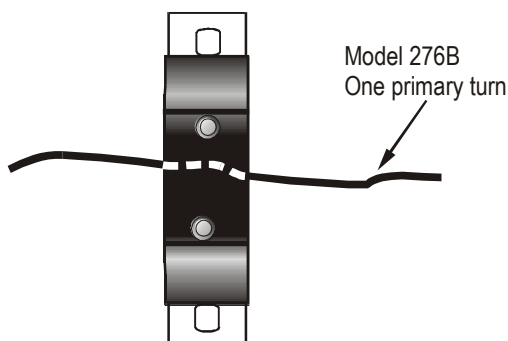

## 276B DIMENSIONS

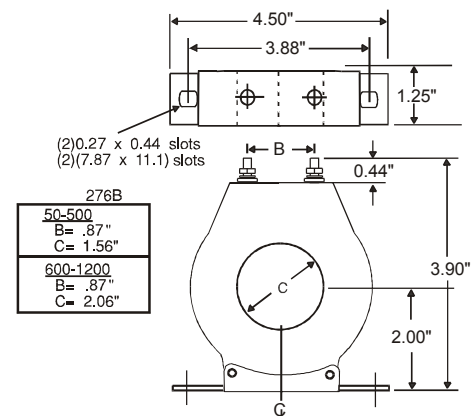

Telephone: Main - (918) 438-1220  
Sales - (800) 862-2875  
Fax: (918) 437-7584

E-mail: sales@time-mark.com  
Internet: http://www.time-mark.com



**TIME MARK**  
CORPORATION

11440 East Pine Street  
Tulsa, Oklahoma 74116

11/2011  
© 2011 TIME MARK CORPORATION

TIME MARK is a division of  AEMT, Inc.

# MODEL 276

# Current Transformers

READ ALL INSTRUCTIONS BEFORE INSTALLING, OPERATING OR SERVICING THIS DEVICE.  
KEEP THIS DATA SHEET FOR FUTURE REFERENCE.

## GENERAL SAFETY

POTENTIALLY HAZARDOUS VOLTAGES ARE PRESENT AT THE TERMINALS OF THE MODEL 276.  
ALL ELECTRICAL POWER SHOULD BE REMOVED WHEN CONNECTING OR DISCONNECTING WIRING.  
THIS DEVICE SHOULD BE INSTALLED AND SERVICED BY QUALIFIED PERSONNEL.

## Installation Instructions

### PRIMARY TURN RATIO MODIFICATION

The nameplate ratio of the current transformer is based on the condition that the primary conductor will be passed once through the transformer window. This rating can be reduced in even multiples by looping the conductor two or more times through the window. A transformer having a rating of 200 to 5 amps will be changed to 50 to 5 amps if four loops or turns are made with the primary cable as illustrated.

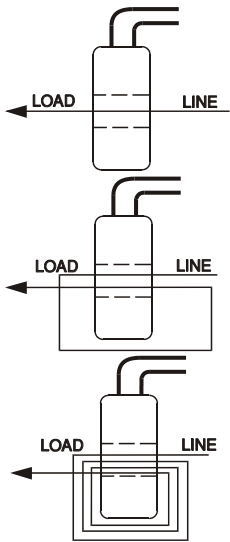

1 Primary Turn			
Nameplate Ratio	Actual Ratio	Nameplate Ratio	Actual Ratio
100:5	100:5	400:5	400:5
150:5	150:5	500:5	500:5
200:5	200:5	600:5	600:5
300:5	300:5	800:5	800:5

2 Primary Turns			
Nameplate Ratio	Actual Ratio	Nameplate Ratio	Actual Ratio
100:5	50:5	400:5	200:5
150:5	75:5	500:5	250:5
200:5	100:5	600:5	300:5
300:5	150:5	800:5	400:5

4 Primary Turns			
Nameplate Ratio	Actual Ratio	Nameplate Ratio	Actual Ratio
100:5	25:5	400:5	100:5
150:5	37.5:5	500:5	125:5
200:5	50:5	600:5	150:5
300:5	75:5	800:5	200:5

The ratio of the current transformer can be modified by altering the number of secondary turns by forward or back-winding the secondary lead through the window of the CT.

By adding secondary turns the same primary amperage will result in a decrease in secondary output. By subtracting secondary turns the same primary amperage will result in greater secondary output.

Again using the 300:5 example, adding 5 secondary turns will require 325 amps on the primary to maintain the 5 amp secondary output, or

$$\frac{325p}{5s} = \frac{65s}{1p}$$

Deducting 5 secondary turns will only require 275 amps on the primary to maintain the 5 amp secondary output, or

$$\frac{275p}{5s} = \frac{55s}{1p}$$

The above ratio modifications are achieved in the following manner.

- To add secondary turns, the white lead should be wound through the CT from the side opposite the polarity mark.

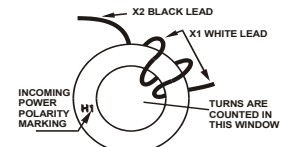

- To subtract secondary turns, the white lead should be wound through the CT from the same side as the polarity mark.

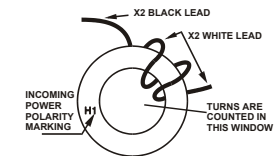

### SECONDARY TURN RATIO MODIFICATION

Formula:  $\frac{I_p}{I_s} = \frac{N_s}{N_p}$

Where:  $I_p$  - Primary amperage  
 $I_s$  - Secondary amperage  
 $N_p$  - Number of primary turns  
 $N_s$  - Number of secondary turns

Example: A 300:5 current transformer

$$\frac{300p}{5s} = \frac{60s}{1p}$$

(in practicality, one turn is dropped from the secondary as a ratio correction factor).

### WARRANTY

This product is warranted to be free from defects in materials and workmanship for one year. Should this device fail to operate, we will repair it for one year from the date of manufacture. For complete warranty details, see the *Terms and Conditions of Sales* page in the front section of the Time Mark catalog or contact Time Mark at 1-800-862-2875.

Telephone: Main - (918) 438-1220  
Sales - (800) 862-2875  
Fax: (918) 437-7584

E-mail: sales@time-mark.com  
Internet: http://www.time-mark.com



**TIME MARK**  
CORPORATION

11440 East Pine Street  
Tulsa, Oklahoma 74116

11/2011  
© 2011 TIME MARK CORPORATION

TIME MARK is a division of  AEMT, Inc.