

**YB-Frame - Miniature Circuit Breakers**



1 Pole  
DIN mount



1 Pole  
DIN mount



2 Pole  
DIN mount

**Product Category**

- **UNPOLARISED PRODUCT**  
150 Vdc (1P & 2P), 300 Vdc (2P in series)  
300 Vdc 4 (2P in series + 2P in series) and  
600 Vdc (4P in series)  
(Reverse feedable)

**Features**

- High energy DC circuit breaker
- Ultra compact - 13 mm wide module
- Hydraulic-magnetic technology
- Can be switched on immediately after tripping
- DIN mount, 45 mm front escutcheon (Grey)
- DIN mount, 57 mm front escutcheon (Black)
- Dual mount, 57 mm front escutcheon (Black)
- ON and OFF indication
- Suitable for electrical isolation
- 100% rating capability, independent of ambient temperature
- RoHS compliant
- Box type main terminals

**Applications**

- Solar equipment
- DC circuit protection
- Telecom / datacom equipment
- UPS equipment
- Alternative energy equipment
- Battery protection

**Auxiliary Switch and Trip Alarm Features**

- Auxiliary switch
- AC and DC voltages
- IEC 60947-5-1 (6 A 250 Vac, 0.5 A 110 Vdc)
- GB 14048.5 approved
- Factory fitted
- Attached to right hand side of circuit breaker
- Compact 6.5 mm width

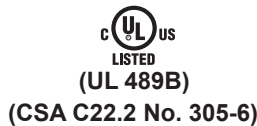

**Hydraulic-Magnetic Circuit Breakers 100% rated, unaffected by ambient temperature**

## YB-Frame - Miniature Circuit Breakers

### Technical Data: Approvals

Product Type	Circuit Breaker YB			
Approvals	IEC 60947-2, GB14048.2, CE, UKCA, AS/NZS 60947-2			
Number of Poles	1 Pole, 2 Pole	2P (Series)	4P (Series)	4 (2 Pole in series + 2 Pole in series)
Operating Voltages & Interrupting Capacity	150 Vdc @ 6 kA	300 Vdc @ 6 kA	600 Vdc @ 6 kA	300 Vdc @ 6 kA
Minimum Current Rating	0.5 A	0.5 A	0.5 A	0.5 A
Maximum Current Rating	50 A	50 A	32 A	50 A

Product Type	Circuit Breaker YB	
Approvals	UL 489B	
Number of Poles	1 Pole	2 Pole
Operating Voltages & Interrupting Capacity	150 Vdc @ 10 kA	150 Vdc @ 10 kA
Minimum Current Rating	0.5 A	0.5 A
Maximum Current Rating	50 A	50 A

Verify approvals for specific ratings in accordance with the relevant test certificates.

Product Type	Circuit Breaker YB
Ambient Operating Temperature	-40 °C to +85 °C
Mounting Options	Dual (DIN and CBI Mini rail)
Time Delay Curves	Various
Endurance	10000 operations; 1500 with current, 8500 without current (IEC 60947-2 Clause 7.2.4.2)* 1000 operations with current, 1000 operations without current (UL 489B Clause 10)*
Dielectric Strength	1000 - 2000 Vac for one minute (IEC 60947-2 Clause 8.3.3.3)* 1000 Vac plus twice the rated voltage for one minute (UL 489B Clause 15)*
Rated Impulse Withstand Voltage	4 kV (IEC 60947-2 Clause 8.3.3.2)*
Weight	110 g per pole
Altitude	Certification tests conducted at altitude ≈ 2000 metres. Will operate at higher altitudes.
Shock	20 G (IEC 60068-2-27)
Vibration	3 G (IEC 60068-2-6) (sinusoidal wave)
Flammability	I3 - Ignition does not persist at 850°C after glow wire is withdrawn with an oxygen index of ≥ 28
Toxicity	F1 - Smoke index of ≤ 20 which determines the fume class
Pollution Degree	PD2 - Normally only non-conductive pollution occurs. Temporary conductivity caused by condensation is to be expected.

\* Refer to the standard for details

Breaker YB	Wire Size (IEC)	Wire Gauge (UL)	Torque (IEC)	Torque (UL)	Comments
Main Terminals	2.5 mm <sup>2</sup> to 16 mm <sup>2</sup>	18 – 6 AWG	3.5 Nm	30 in-lb	Pozidriv #2 Combi head

## YB-Frame - Miniature Circuit Breakers

### Long Code

Example Code: YBD- - -1 -(13)-M-50A- 150 - - - -

Group	1	2	3	4	5	6	7	8	9	10
Requirement	YBD frame	Auxiliary	Number of poles	Module width	Time delay curve	Current rating	Polarity marking, voltage & construction	Shunt trip	Termination	Customer Specific
Long Code	YBD	-	1	(13)	M	50A	150	-	-	-

### Ordering Information

Group	Code	Description	Comments
Group 1: Frame Type	YBD	YB - Frame (13 mm circuit breaker DIN mounting 57 mm front escutcheon)	Black shell
	YAK	YB - Frame (13 mm circuit breaker Dual mounting 57 mm front escutcheon)	Black shel
	YBM	YB - Frame (13 mm circuit breaker DIN mounting 45 mm front escutcheon)	Grey shell
Group 2: Auxiliary	-	Not applicable	
	A	Auxiliary switch	
	T	Trip alarm	
	AT	Auxiliary switch & Trip alarm	
Group 3: Number of poles	1	One pole	
	2	Two pole	
	4	Four pole	
Group 4: Module Width	(13)	13 mm module	
Group 5: Time Delay	I	Instantaneous delay	
	S	Short dealy	
	M	Medium delay	
	L	Long delay	
Group 6: Current Rating		0.5, 1, 2, 3, 5, 6, 10, 15, 16, 20, 25, 30, 32, 35, 40, 45, 50 A	
Group 7: Polarity Marking, Voltage & Construction	150	150 Vdc Unpolarised	
	300	300 Vdc Unpolarised, series connection	
	600	600 Vdc Unpolarised, series connection	
Group 8: Shunt Trip	-	Not applicable	if shunt trip is not required
	C	12 Vdc Shunt trip (Box terminal)	Recommended pulse tolarence 100 ms - 60 s Note: Shunt trip option carries no approvals - available as a special order only
	D	24 Vdc Shunt trip (Box terminal)	
	E	48 Vdc Shunt trip (Box terminal)	
	G	110 Vdc or 110 Vac Shunt trip (Box terminal)	
	H	220 / 240 Vac Shunt trip (Box terminal)	
Group 9: Termination	-	Not applicable	No busbar supplied - if applicable the busbar / cable is to be provided & field fitted by the customer
	S	Factory fitted busbar - incoming circuit CONNECTION @ BOTTOM	
	U	Busbar to be supplied loose in a KIT FORM & to be field fitted by customer	
	T	Factory fitted Busbar - incoming circuit CONNECTION @ TOP	

For options not listed, please contact CBI for assistance

**YB-Frame - Miniature Circuit Breakers**

**Time Delay Curve**

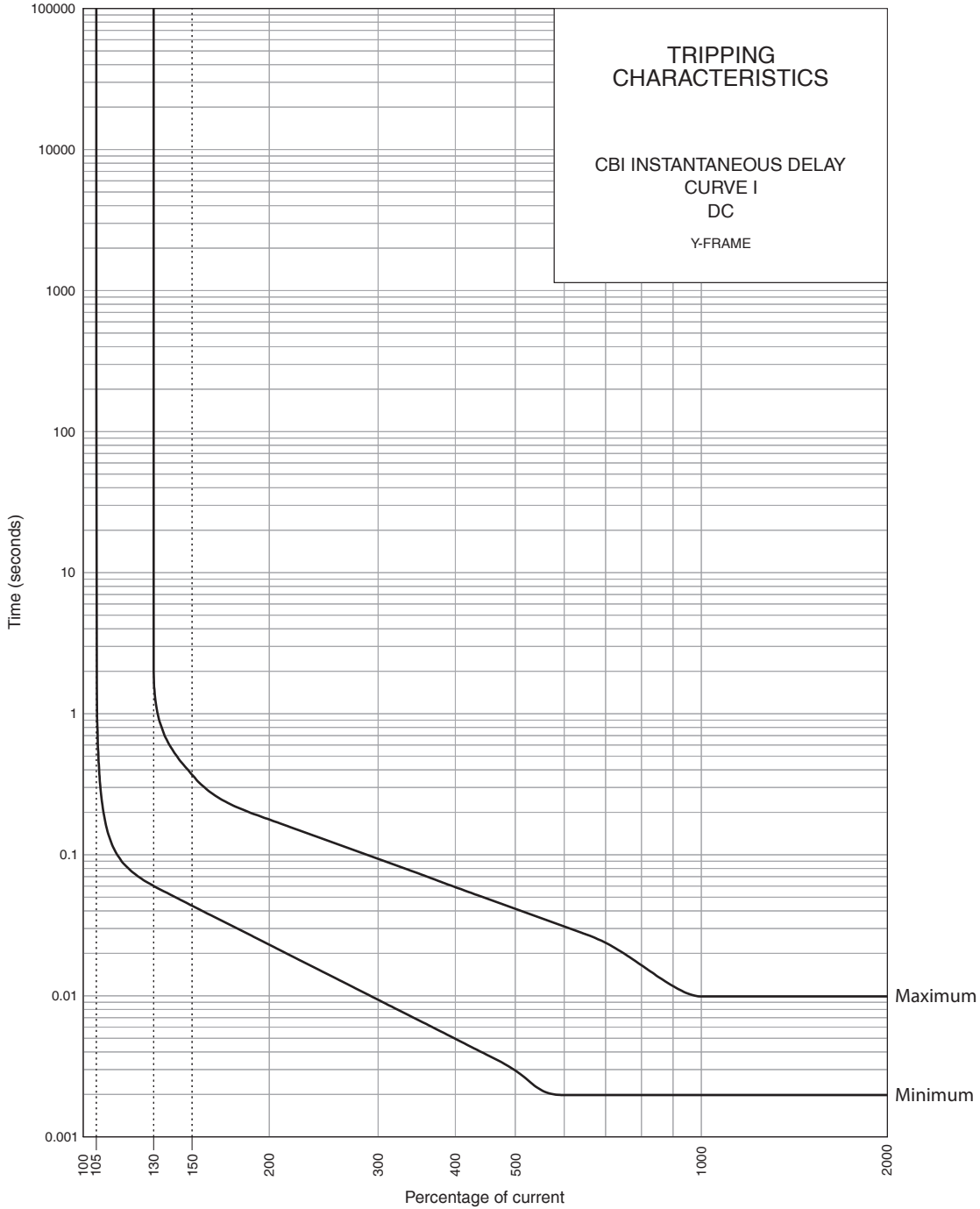

3990A961 REV. A

PERCENTAGE OF RATED CURRENT	105%	130%	150%	200%	300%	400%	500%	600%	700%	800%	900%	1000%	1200%
MINIMUM TRIP TIME IN SECONDS	NO TRIP	0.06	0.04	0.02	0.009	0.005	0.003	0.002	0.002	0.002	0.002	0.002	0.002
MAXIMUM TRIP TIME IN SECONDS	NO TRIP	2	0.4	0.2	0.09	0.1	0.04	0.03	0.02	0.016	0.012	0.01	0.01

**YB-Frame - Miniature Circuit Breakers**

**Time Delay Curve**

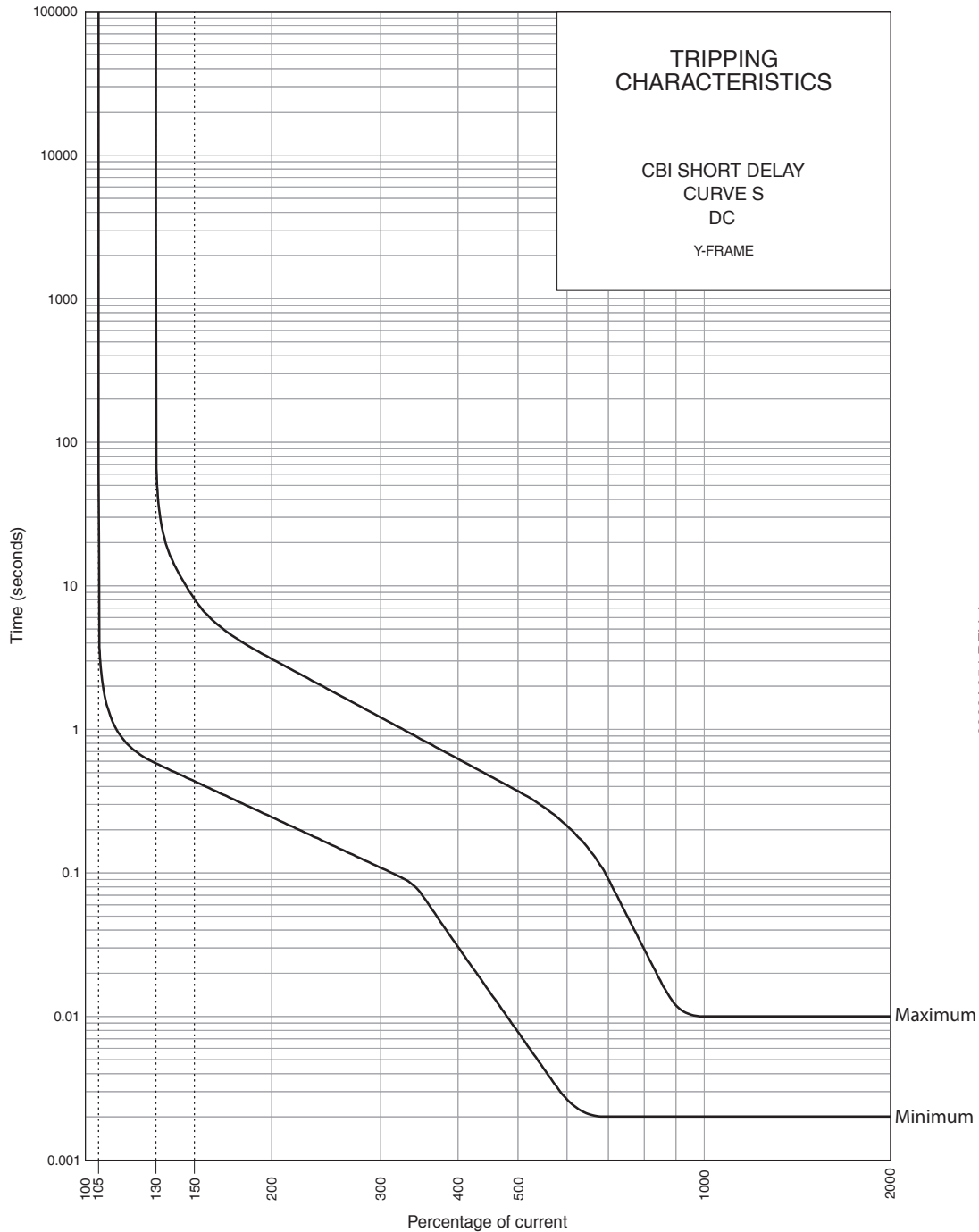

3990A954 REV. A

PERCENTAGE OF RATED CURRENT	105%	130%	150%	200%	300%	400%	500%	600%	700%	800%	900%	1000%	1200%
MINIMUM TRIP TIME IN SECONDS	NO TRIP	0.58	0.44	0.2	0.1	0.03	0.01	0.003	0.002	0.002	0.002	0.002	0.002
MAXIMUM TRIP TIME IN SECONDS	NO TRIP	3000	8.1	3.1	1.21	0.6	0.4	0.2	0.1	0.03	0.012	0.01	0.01

**YB-Frame - Miniature Circuit Breakers**

**Time Delay Curve**

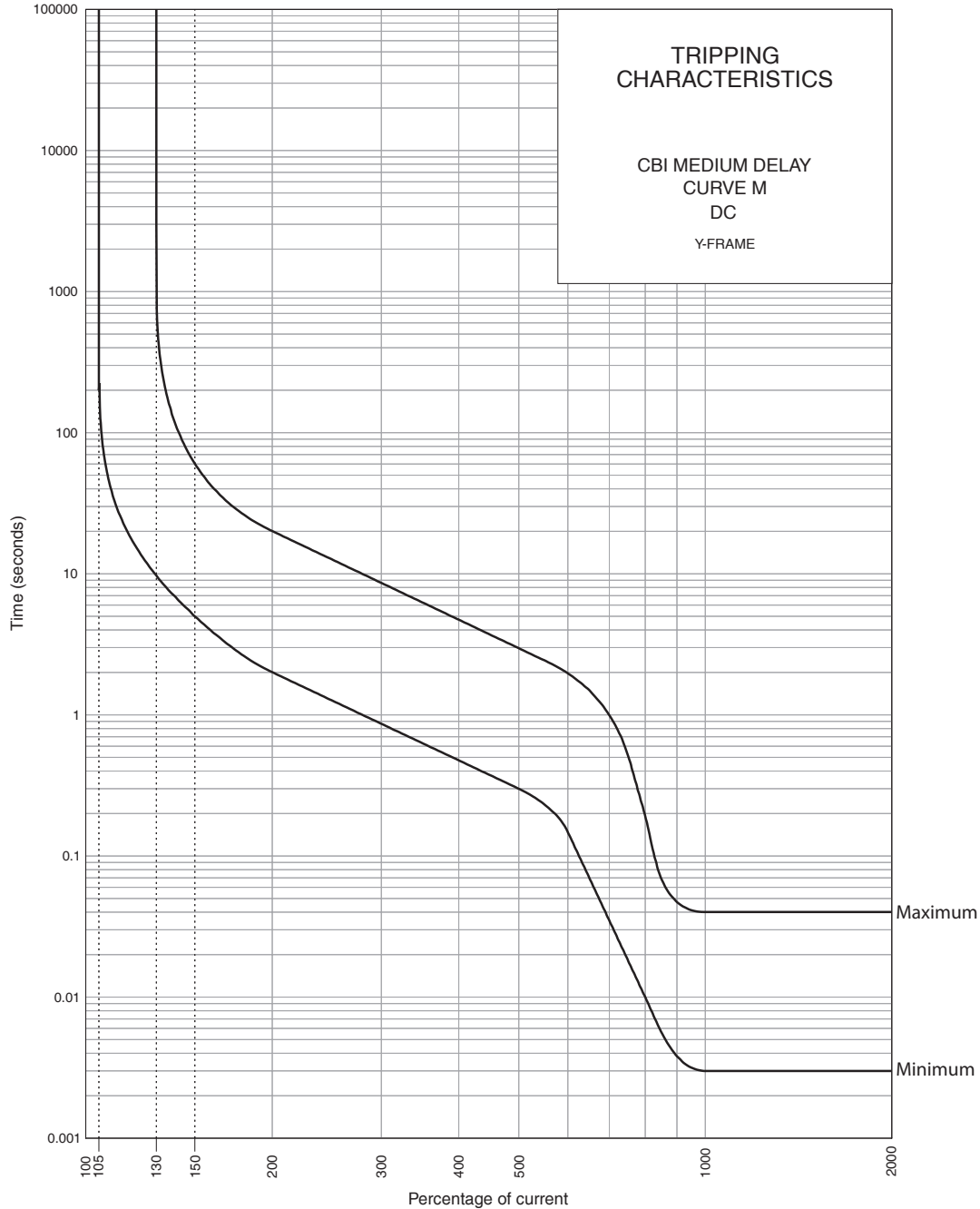

3990A883 REV. B

PERCENTAGE OF RATED CURRENT	105%	130%	150%	200%	300%	400%	500%	600%	700%	800%	900%	1000%	1200%
MINIMUM TRIP TIME IN SECONDS	NO TRIP	9.7	4.99	2.0	0.9	0.48	0.3	0.15	0.03	0.01	0.004	0.003	0.003
MAXIMUM TRIP TIME IN SECONDS	NO TRIP	3000	60.0	20.0	8.62	4.7	3.0	1.97	0.99	0.19	0.05	0.04	0.04

**YB-Frame - Miniature Circuit Breakers**

**Time Delay Curve**

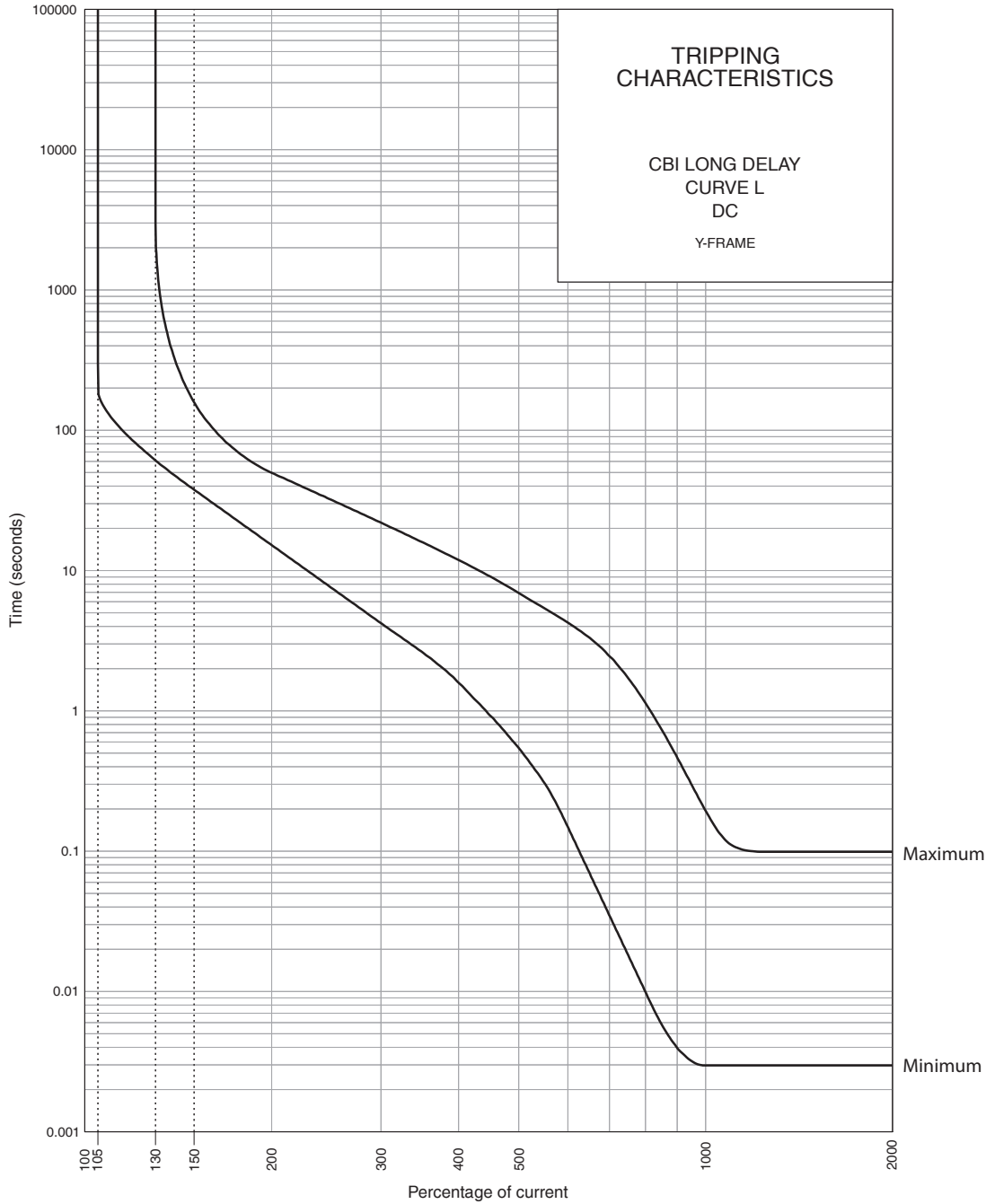

PERCENTAGE OF RATED CURRENT	105%	130%	150%	200%	300%	400%	500%	600%	700%	800%	900%	1000%	1200%
MINIMUM TRIP TIME IN SECONDS	NO TRIP	60.9	37.7	15.2	4.2	1.6	0.54	0.15	0.03	0.01	0.004	0.003	0.003
MAXIMUM TRIP TIME IN SECONDS	NO TRIP	3000	158.3	49.8	21.98	11.9	6.9	4.3	2.5	1.1	0.5	0.2	0.1

## YB-Frame - Miniature Circuit Breakers

DIN mounting 45 mm escutcheon			DIN mounting 57 mm escutcheon	
AMP	BOM No.	Long Code	BOM No.	Long Code
<b>One pole - (150 Vdc) - 13 mm total width</b>				
0.5 A	YBD1M0A5150	YBD-1(13)-M-0.5 A-150	YBM1M0A5150	YBM-1(13)-M-0.5A-150
1 A	YBD1M001150	YBD-1(13)-M-1A-150	YBM1M001150	YBM-1(13)-M-1A-150
2 A	YBD1M002150	YBD-1(13)-M-2A-150	YBM1M002150	YBM-1(13)-M-2A-150
3 A	YBD1M003150	YBD-1(13)-M-3A-150	YBM1M003150	YBM-1(13)-M-3A-150
5 A	YBD1M005150	YBD-1(13)-M-5A-150	YBM1M005150	YBM-1(13)-M-5A-150
6 A	YBD1M006150	YBD-1(13)-M-6A-150	YBM1M006150	YBM-1(13)-M-6A-150
10 A	YBD1M010150	YBD-1(13)-M-10A-150	YBM1M010150	YBM-1(13)-M-10A-150
15 A	YBD1M015150	YBD-1(13)-M-15A-150	YBM1M015150	YBM-1(13)-M-15A-150
16 A	YBD1M016150	YBD-1(13)-M-16A-150	YBM1M016150	YBM-1(13)-M-16A-150
20 A	YBD1M020150	YBD-1(13)-M-20A-150	YBM1M020150	YBM-1(13)-M-20A-150
25 A	YBD1M025150	YBD-1(13)-M-25A-150	YBM1M025150	YBM-1(13)-M-25A-150
30 A	YBD1M030150	YBD-1(13)-M-30A-150	YBM1M030150	YBM-1(13)-M-30A-150
32 A	YBD1M032150	YBD-1(13)-M-32A-150	YBM1M032150	YBM-1(13)-M-32A-150
35 A	YBD1M035150	YBD-1(13)-M-35A-150	YBM1M035150	YBM-1(13)-M-35A-150
40 A	YBD1M040150	YBD-1(13)-M-40A-150	YBM1M040150	YBM-1(13)-M-40A-150
45 A	YBD1M045150	YBD-1(13)-M-45A-150	YBM1M045150	YBM-1(13)-M-45A-150
50 A	YBD1M050150	YBD-1(13)-M-50A-150	YBM1M050150	YBM-1(13)-M-50A-150
<b>Two pole - (150 Vdc) - 26 mm total width</b>				
0.5 A	YBD2M0A5150	YBD-2(13)-M-0.5A-150	YBM2M0A5150	YBM-2(13)-M-0.5A-150
1 A	YBD2M001150	YBD-2(13)-M-1A-150	YBM2M001150	YBM-2(13)-M-1A-150
2 A	YBD2M002150	YBD-2(13)-M-2A-150	YBM2M002150	YBM-2(13)-M-2A-150
3 A	YBD2M003150	YBD-2(13)-M-3A-150	YBM2M003150	YBM-2(13)-M-3A-150
5 A	YBD2M005150	YBD-2(13)-M-5A-150	YBM2M005150	YBM-2(13)-M-5A-150
6 A	YBD2M006150	YBD-2(13)-M-6A-150	YBM2M006150	YBM-2(13)-M-6A-150
10 A	YBD2M010150	YBD-2(13)-M-10A-150	YBM2M010150	YBM-2(13)-M-10A-150
15 A	YBD2M015150	YBD-2(13)-M-15A-150	YBM2M015150	YBM-2(13)-M-15A-150
16 A	YBD2M016150	YBD-2(13)-M-16A-150	YBM2M016150	YBM-2(13)-M-16A-150
20 A	YBD2M020150	YBD-2(13)-M-20A-150	YBM2M020150	YBM-2(13)-M-20A-150
25 A	YBD2M025150	YBD-2(13)-M-25A-150	YBM2M025150	YBM-2(13)-M-25A-150
30 A	YBD2M030150	YBD-2(13)-M-30A-150	YBM2M030150	YBM-2(13)-M-30A-150
32 A	YBD2M032150	YBD-2(13)-M-32A-150	YBM2M032150	YBM-2(13)-M-32A-150
35 A	YBD2M035150	YBD-2(13)-M-35A-150	YBM2M035150	YBM-2(13)-M-35A-150
40 A	YBD2M040150	YBD-2(13)-M-40A-150	YBM2M040150	YBM-2(13)-M-40A-150
45 A	YBD2M045150	YBD-2(13)-M-45A-150	YBM2M045150	YBM-2(13)-M-45A-150
50 A	YBD2M050150	YBD-2(13)-M-50A-150	YBM2M050150	YBM-2(13)-M-50A-150

**Note:**

The "M" after the number in the Re-order number i.e. YBD2M0A5 represents the time delay tripping curves

If a different curve is required please replace the "M" with the appropriate curve



**YB-Frame - Miniature Circuit Breakers**

**Possible used Connections Diagrams**

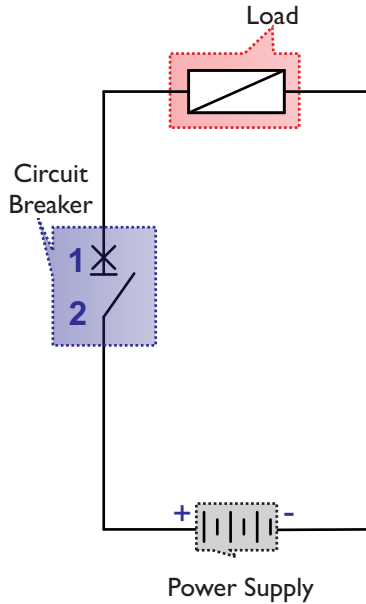

**Figure 1:  
Single Pole, Single Break  
(150 Vdc)**

**Figure 1: Single Pole, Single Break (150 Vdc)**

This circuit makes use of a single pole circuit breaker connected in series with the load.

**Figure 2: Double Pole, Single Break (300 Vdc)**

This circuit makes use of a double pole circuit breaker connected in series each pole 150 Vdc with the load.

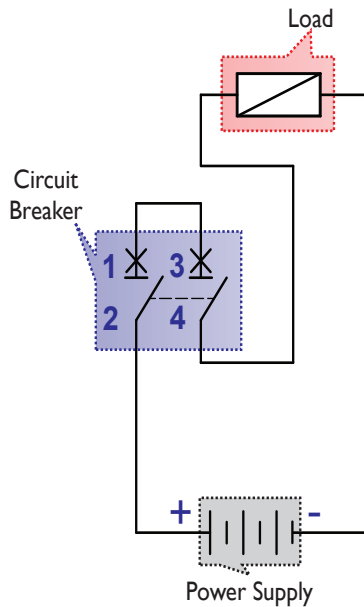

**Figure 2:  
Double Pole, Single Break  
(300 Vdc)**

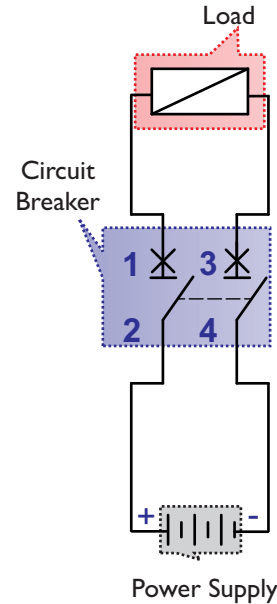

**Figure 3:  
Double Pole, Double  
Break. Isolates Load  
(150 Vdc, 300 Vdc)**

**Figure 3: Double Pole, Double Break. Isolates load  
(150 Vdc, 300 Vdc)**

This circuit makes use of a double pole circuit breaker where the load is between the contacts, providing full isolation to the load each pole 150 Vdc.

**Notes:**

1. Products are rated at 150 Vdc per pole, and will function at voltages below rated voltage.
2. Other types of connections are possible.

## YB-Frame - Miniature Circuit Breakers

### Outline Dimensions: DIN Mount 45 mm front Escutcheon (Grey)

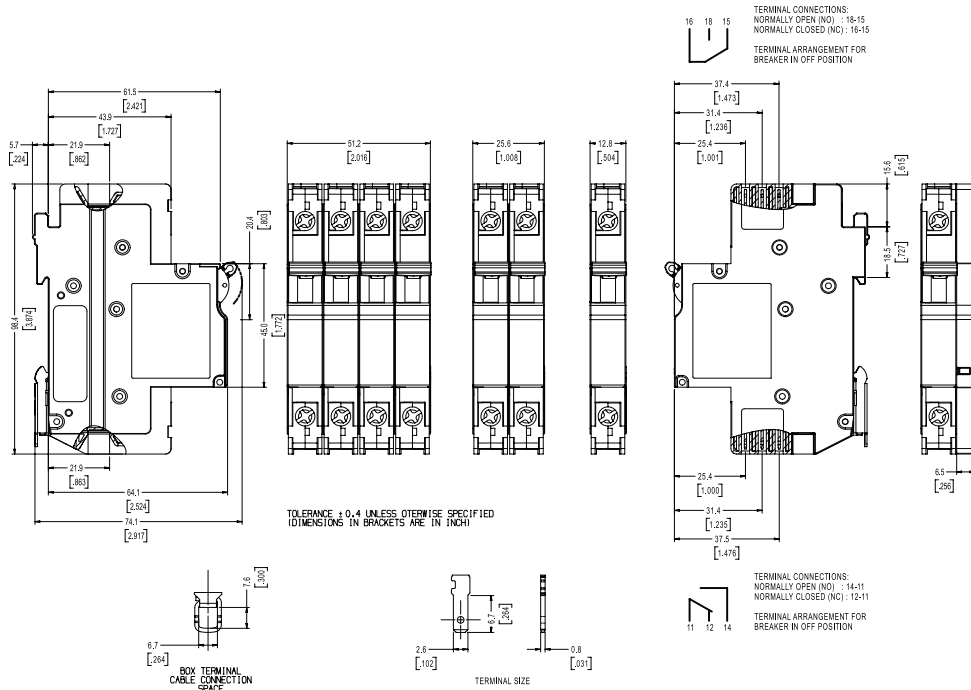

### Outline Dimensions: DIN Mount 57 mm front Escutcheon (Black)

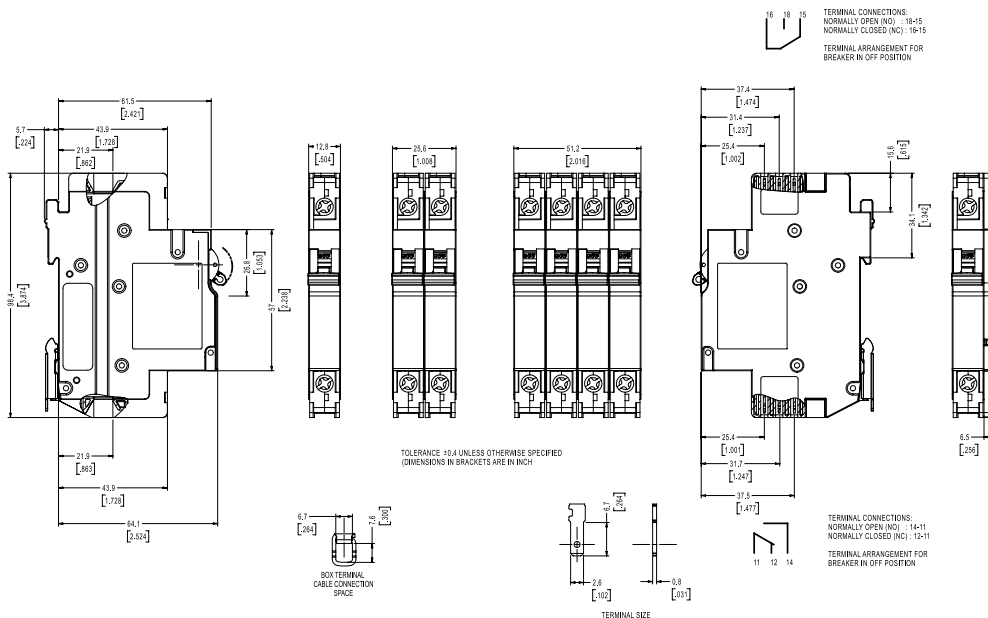

Please review our Customer Terms and Conditions on [www.cbi-lowvoltage.co.za](http://www.cbi-lowvoltage.co.za)

© CBI (Pty) Ltd. All Rights Reserved.

All rights reserved. Unless otherwise indicated, all materials on these pages are copyrighted by CBI (Pty) Ltd. No part of these pages, either text or image may be used for any purpose other than personal use. Therefore, reproduction, modification, storage in a retrieval system or retransmission, in any form or by any means, electronic, mechanical or otherwise, for reasons other than personal use, is strictly prohibited without prior written permission. CBI (Pty) Ltd reserves the right to alter any details of this document without notice and while every effort is made to ensure the accuracy of the content, no warranty is given as to the accuracy of this document and no responsibility will be accepted for error or misinterpretation and any resulting loss.

#### AUSTRALIA

**CBI-electric: Australia**  
27 Wedgewood Rd, Hallam  
Victoria 3803 Australia  
Tel: +61 3 8752 9300  
Fax: +61 3 9796 5407  
Email: [sales@cbi-electric.com.au](mailto:sales@cbi-electric.com.au)  
Website: [www.cbi-electric.com.au](http://www.cbi-electric.com.au)

#### INDIA

**CBI-electric: Asia**  
A1, Pushpagiri Residency, 1st Cross  
2nd Main, Jyothi Nagar, B.G Road  
Bengaluru 560083, India  
Tel: +91-9880553153  
Email: [salesasia@cbi-electric.com](mailto:salesasia@cbi-electric.com)  
Website: [www.cbibreakers.com](http://www.cbibreakers.com)  
Website: [www.cbi-lowvoltage.com](http://www.cbi-lowvoltage.com)

#### SOUTH AFRICA

**CBI-electric: low voltage**  
Tripswitch Drive Elandsfontein  
Gauteng South Africa  
Tel: +27 11 928 2000  
Fax: +27 11 392 2354  
Email: [cbi@cbi-electric.com](mailto:cbi@cbi-electric.com)  
[internationalsales@cbi-electric.com](mailto:internationalsales@cbi-electric.com)  
Website: [www.cbi-lowvoltage.co.za](http://www.cbi-lowvoltage.co.za)

#### USA

**CBI-electric: North America**  
35 E. Uwchlan Ave Suite 328  
Exton PA 19341 USA  
Tel: +1 610 524 9949  
Fax: +1 610 524 9945  
E-mail: [info@cbibreakers.com](mailto:info@cbibreakers.com)  
Website: [www.cbibreakers.com](http://www.cbibreakers.com)