

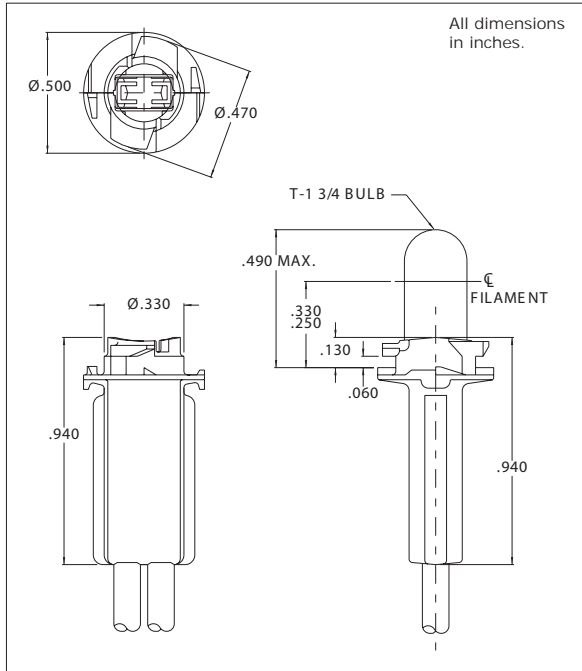

4106 Series Relampable Socket

DESCRIPTION AND FEATURES



Features

Mounting: Rear twist insertion in .060 thick plastic panels or .050/.055 thick metal panels.
Mounting hole pattern on page SP3.

Wire Leads: No.20 AWG, 4.4/4.8 long, stripped .430/.570, color: black

Lamp: T-1 3/4 Wedge base

Housing: Black nylon

Note: Available with other leads and/or terminals on special order. Lamps must be ordered separately.