

Annex to the
technical catalogue

Tmax T8

Low voltage moulded-case
circuit-breaker up to 3200 A

1SDC210027D0201 – 2008 Edition



ABB



Index

Main characteristics.....	3
Protection trip units	6
Accessories.....	7
Characteristic curves and technical information	13
Wiring diagrams	22
Overall dimensions	31
Ordering codes.....	37

Main characteristics

The Tmax family is enriched with the Tmax T8 size, which allows 3200 A to be reached. Also available in the 2000 A and 2500 A frames, Tmax T8 is equipped with the same electronic trip units as Tmax T7, thereby guaranteeing extremely high performances able to satisfy all installation requirements. Adequately sized for the performances offered (W = 427 / D = 282 / H = 382 mm), it is supplied as standard with front terminals up to 2500 A (if necessary it can be supplied with orientated rear terminals and front extended spread terminals), whereas the 3200 A frame is always supplied with rear vertical terminals.

Tmax T8 is available with two breaking capacities: 85 kA and 130 kA at 415 V.



Main characteristics

General Characteristics

The Tmax T8 range has both circuit-breakers (with a range dedicated to applications at 1000 V in AC) and switch-disconnectors. The following tables show the main characteristics of these ranges.

Circuit-breakers for power distribution

					Tmax T8								
Rated uninterrupted current, Iu (A) (A)					2000/2500/3200								
Poles (No.)					3/4								
Rated service voltage, Ue (AC) 50-60 Hz (V)					690								
					(DC) (V)					-			
Rated impulse withstand voltage, Uimp (kV)					12								
Rated insulation voltage, Ui (V)					1000								
Test voltage at industrial frequency for 1 min. (V)					3500								
Rated ultimate short-circuit breaking capacity, Icu (AC) 50-60 Hz 220/230 V (kA)					L		V						
					(AC) 50-60 Hz 380/415 V (kA)					85		130	
					(AC) 50-60 Hz 440 V (kA)					85		130	
					(AC) 50-60 Hz 500 V (kA)					85		130	
					(AC) 50-60 Hz 500 V (kA)					65		100	
					(AC) 50-60 Hz 690 V (kA)					50		80	
Rated service short-circuit breaking capacity, Ics (AC) 50-60 Hz 220/230 V (%Icu)					100%		75%						
					(AC) 50-60 Hz 380/415 V (%Icu)					100%		75%	
					(AC) 50-60 Hz 440 V (%Icu)					100%		75%	
					(AC) 50-60 Hz 500 V (%Icu)					100%		75%	
					(AC) 50-60 Hz 690 V (%Icu)					100%		75%	
Rated short-circuit making capacity, Icm (AC) 50-60 Hz 220/230 V (kA)					187		286						
					(AC) 50-60 Hz 380/415 V (kA)					187		286	
					(AC) 50-60 Hz 440 V (kA)					187		286	
					(AC) 50-60 Hz 500 V (kA)					143		220	
					(AC) 50-60 Hz 690 V (kA)					105		176	
Opening time (415 V) at Icu (ms)					30								
Utilisation category (IEC 60947-2)					B ⁽¹⁾								
Isolation behaviour					■								
Reference Standard					IEC 60947-2								
Trip units: electronic PR232/P-T8 PR331/P PR332/P					■								
										■			
										■			
Interchangeability					■								
Versions					F								
Terminals					F - HR/VR - ES - VR ⁽²⁾								
Mechanical life [No. operations]					15000								
					[No. Hourly operations]					60			
Electrical life @ 415 V AC [No. operations]					4500 (2000A) - 4000 (2500A) - 3000 (3200A)								
					[No. Hourly operations]					20			
Basic dimensions 3 poles W (mm)					427								
					4 poles W (mm)					553			
					D (mm)					282			
					H (mm)					382			
Weight Fixed 2000 A / 2500 A 3/4 poles (kg)					73/95								
					3200 A 3/4 poles (kg)					107/140			

TERMINAL CAPTION

F = Front
 HR/VR = Rear flat orientated
 ES = Front extended spread terminals
 VR = Rear vertical

⁽¹⁾ Icw = 40 kA

⁽²⁾ On T8 3200 A only VR terminals are available

Switch-disconnectors

The Tmax T8 switch-disconnectors are derived from the corresponding circuit-breakers, of which they keep the overall dimensions. The versions, fixing systems and the possibility of fitting accessories are unchanged. This version only differs from the circuit-breakers in the absence of a trip unit.

Switch-disconnectors

				Tmax T8D	
Conventional thermal current, I_{th}		(A)		2000/2500/3200	
Rated service current in category AC23, I_e		(A)		2000/2500/3200	
Poles		(No.)		3/4	
Rated service voltage, U_e (AC) 50-60 Hz		(V)		690	
		(DC)		750	
Rated impulse withstand voltage, U_{imp}		(kV)		12	
Rated insulation voltage, U_i		(V)		1000	
Test voltage at industrial frequency for 1 minute		(V)		3500	
Rated short-circuit making capacity, I_{cm}					
		(min) switch-disconnector only		(kA)	
				84	
Rated short-time withstand current for 1s, I_{cw}				(kA)	
				40	
Isolation behaviour				■	
Reference Standard				IEC 60947-2	
Versions				F	
Terminals		Fixed		F - HR/VR - ES - VR ⁽¹⁾	
Mechanical life				[No. operations]	
				15000	
				[No. Hourly operations]	
				60	
Basic dimensions		3 poles		W (mm)	
				427	
		4 poles		W (mm)	
				553	
				D (mm)	
				282	
				H (mm)	
				382	
Weight		Fixed			
		2000 A / 2500 A		3/4 poles	
				(kg)	
				73/95	
		3200 A		3/4 poles	
				(kg)	
				107/140	

TERMINAL CAPTION

F = Front

HR/VR = Rear flat orientated

ES = Front extended spread terminals

VR = Rear vertical

⁽¹⁾ On T8 3200 A only VR terminals are available

Automatic circuit-breakers coordination (380/415 V AC)

I_{cu} (kA)	T8 2000		T8 2500		T8 3200	
	L	V	L	V	L	V
	85	130	85	130	85	130
T8D 2000	85	130	85 ⁽¹⁾	130 ⁽¹⁾	85 ⁽¹⁾	130 ⁽¹⁾
T8D 2500	85	130	85	130	85 ⁽¹⁾	130 ⁽¹⁾
T8D 3200	85	130	85	130	85	130

⁽¹⁾ Suitable only if I₁ (Automatic) ≤ I_{th} (Switch-disconnector)

Protection trip units

Electronic trip units

The Tmax T8 circuit-breakers can be equipped with the same protection trip units as those available on the Tmax T7 circuit-breaker, except for the PR231 which is not provided on T8. The protection trip units available are therefore:

- PR232/P-T8
- PR331/P
- PR332/P.

For further details, please consult the technical catalogue: "Tmax – Low Voltage moulded-case circuit-breakers up to 1600 A" (code 1SDC210015D0203).

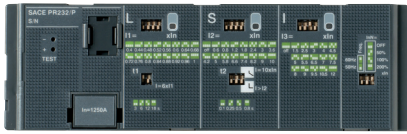

SACE PR232/P-T8

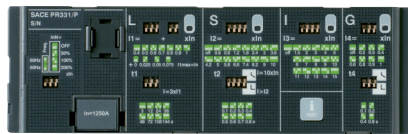

SACE PR331/P



SACE PR332/P

Interchangeability

Tmax T8 circuit-breakers can be equipped either with PR232/P-T8, PR331/P and PR332/P trip units. Thanks to their simplicity to change the rating plug, the end customer can change the In of the circuit breaker extremely rapidly.

Trip units

Circuit-breakers	PR232/P						PR331/P						PR332/P					
	1000	1250	1600	2000	2500	3200	1000	1250	1600	2000	2500	3200	1000	1250	1600	2000	2500	3200
T8 2000	▲	▲	▲	■			▲	▲	▲	■			▲	▲	▲	■		
T8 2500	▲	▲	▲	▲	■		▲	▲	▲	▲	■		▲	▲	▲	▲	■	
T8 3200	▲	▲	▲	▲	▲	■	▲	▲	▲	▲	▲	■	▲	▲	▲	▲	▲	■

- = complete circuit-breaker already coded
- ▲ = circuit-breaker to be assembled (rating plug extracode to be added)

NOTE: PR332/P-LSIRc trip unit is not available for 3200 A frame

Range of application of the alternating current circuit-breakers

AC	Trip unit	Range (A)
T8 2000/2500/3200	PR232/P-T8	1000...3200
	PR331/P	1000...3200
	PR332/P	1000...3200

Rating plug

Circuit-breaker	Rated current lu	1000	1250	1600	2000	2500	3200
T8	2000	■	■	■	■		
	2500	■	■	■	■	■	
	3200	■	■	■	■	■	■

Accessories

Tmax T8 can be fitted with a complete range of accessories, which allows the user to deal with different plant requirements. From the viewpoint of the request for standardisation in the market, Tmax T8 is able to offer most of its accessories in common with other circuit-breaker sizes. The various types of accessories which can equip Tmax T8 are given below.

Connection terminals

The basic version of Tmax T8 is supplied with front terminals (F) for the 2000 A and 2500 A frames. For the 3200 A frame, rear vertical terminals (RV) are supplied as standard. Circuit-breakers up to 2500 A are also available with rear orientated terminals and extended spread terminals.

For each type of terminal, the tables below summarise the information needed to make the connections.

Front terminals - F

Allow connection of busbars or cables terminated with cable terminals

Type	Version	Pieces	Busbars/cable terminals (mm)			Tightening B (Nm)	Phase separators
			W	D	Ø		
T8 2000	F	3	100	5	4 x 15	70 ⁽¹⁾	R
T8 2500	F	4	100	5	4 x 15	70 ⁽¹⁾	R

Rear flat orientated terminals - HR/VR

Allow connection of busbars at the rear. They can be installed horizontally or vertically

Type	Version	Pieces	Busbars/cable terminals (mm)			Tightening B (Nm)	Phase separators
			W	D	Ø		
T8 2000	F	3	100	5	4 x 15	70 ⁽¹⁾	R
T8 2500	F	4	100	5	4 x 15	70 ⁽¹⁾	R

Front extended spread terminals - ES

Allow connection of cables terminated with cable terminal

Type	Version	Pieces	Cable terminals (mm)		Tightening (Nm)		Phase separators
			L	Ø	A	B	
T8 2000	F	6	44	17	40	40	R
T8 2500	F	6	44	17	40	40	R

Rear vertical terminals - VR

Allow connection of busbars at the rear

Type	Version	Pieces	Busbars/cable terminals (mm)			Tightening B (Nm)	Phase separators
			W	D	Ø		
T8 3200	F	6	100	5	4 x 18	100 ⁽²⁾	R

⁽¹⁾ Class 8.8 M12 screw

⁽²⁾ Class 8.8 M16 screw

A = Tightening the terminal onto the circuit-breaker

B = Tightening the cable terminal onto the terminal

Accessories

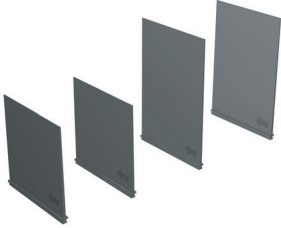

1SDC210015DF0001



YO

1SDC200161F0001



YC

1SDC200132F0001



1SDC200138F0001

Phase separators

These allow to increase the insulation characteristics between the phases at the connections. They are mounted from the front, even with the circuit-breaker already installed.

Two versions are available for Tmax circuit-breakers:

- 100 mm high
- 200 mm high.

Shunt opening/closing release (YO/YC) and second shunt opening release (YO2)

According to the installation position, these devices allow remote opening or closing control of the apparatus. They can be supplied either by means of impulses with a minimum duration of 100 ms, or permanently. In the latter case, the following conditions must be checked:

- when a shunt opening release is permanently supplied, wait 30 ms from de-energisation before giving a closing command
- when a shunt closing release is supplied to carry out circuit-breaker reclosing after opening, it is necessary to momentarily de-energise the shunt closing release (the circuit-breaker operating mechanism is, in fact, fitted with the anti-pumping device).

Operation of the releases is guaranteed for a voltage between 70% / 85% (YO/YC) and 110% of the rated power supply voltage U_n , both in alternating and in direct current.

For the installations where it is necessary to have extremely high safety of the circuit-breaker remote opening command, it is possible to equip T8 with a second shunt opening release. This device is fitted with a special support which can fit the standard shunt closing and opening releases. The seat of the second shunt opening release is also used to fit the undervoltage release, and is therefore incompatible. The special support including the second shunt opening release is installed in place of the standard support. The technical characteristics of the second shunt opening release is the same as those of the standard shunt opening release.

Version	Inrush power consumption		Continuous power consumption	
	AC [VA]	DC [W]	AC [VA]	DC [W]
24 V DC		200		5
30 V AC/DC	200	200	5	5
48 V AC/DC	200	200	5	5
60 V AC/DC	200	200	5	5
110-120 V AC/DC	200	200	5	5
120-127 V AC/DC	200	200	5	5
220-240 V AC/DC	200	200	5	5
240-250 V AC/DC	200	200	5	5
380-400 V AC	200		5	
440 V AC	200		5	
Opening time (YO-YO2) [ms]	≤ 60	≤ 60	≤ 60	≤ 60
Closign time (YC) [ms]	≤ 80	≤ 80	≤ 80	≤ 80

SOR Test Unit

The SOR Test Unit monitors correct functionality of the shunt opening releases which can be mounted on Tmax T8. This device cyclically checks continuity of the shunt opening release and reports via a LED.

For further details, please consult the technical catalogue: "Tmax – Low Voltage moulded-case circuit-breakers up to 1600 A" (code 1SDC210015D0203).

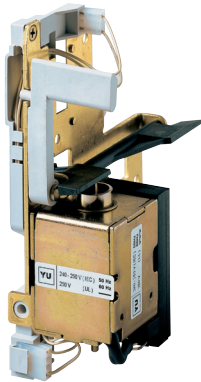

YU

1SDC200138F0001

Undervoltage release (YU)

The undervoltage release carries out circuit-breaker opening in the case of notable lowering or lack of power supply voltage of the latter. The power supply of the release is connected to the supply side of the circuit-breaker or from an independent source and circuit-breaker closing is only possible with the release supplied (the lock on closing is made mechanically).

The release can operate either in direct or alternating current. Circuit-breaker opening takes place with release power supply voltage values equal to 35-70% U_n , whereas circuit-breaker closing is possible with release power supply voltage within the 85-110% U_n range. It can be fitted with a contact signalling the undervoltage release is de-energised.

Version	Power consumption during permanent operation Tmax T8	
	AC [VA]	DC [W]
24 V DC		5
30 V AC/DC	5	5
48 V AC/DC	5	5
60 V AC/DC	5	5
110-120 V AC/DC	5	5
120-127 V AC/DC	5	5
220-240 V AC/DC	5	5
240-250 V AC/DC	5	5
380-400 V AC	5	–
440 V AC	5	–
Opening time [ms]	30	30



1SDC200138F0001

Time delay device for undervoltage release

The undervoltage release can be combined with an external electronic power supply time delay device, which allows circuit-breaker opening to be delayed in the case of lowering or lack of power supply voltage of the release itself, according to established and adjustable delays, so as to avoid undesired trips caused by temporary malfunctions. The time delay device must be combined with an undervoltage release of corresponding voltage.

Circuit-breaker	Power supply [V AC/DC]
T8	24...30
	48
	60
	110...125
	220...250
Adjustable opening time [s]	0.5 - 1 - 1.5 - 2 - 3

Electric signals

The Tmax T8 circuit-breaker can be fitted with a complete range of auxiliary contacts able to take the information about its state of operation outside the circuit-breaker. These auxiliary contacts are available for use both in direct and in alternating current at different voltages.

Accessories

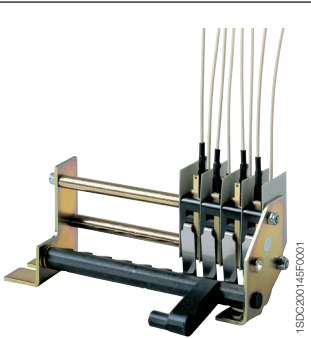

Auxiliary status contacts

These are auxiliary contacts on changeover for signalling circuit-breaker open or closed and are available in the following two combinations:

- 4 open/closed contacts for PR232-T8 and PR331
- 4 open/closed contacts for PR332 (4 contacts on changeover + 1 contact dedicated to the release).

The auxiliary contacts are available with rated voltage of 400 V or for lower rated voltages at 24 V (digital signals).

The auxiliary contacts for PR332 are always supplied with automatic circuit-breakers.

Electric signalling of overcurrent release trip

This allows visual signalling (mechanical-standard) and remote signalling (electrical-optional) in the case of circuit-breaker open following overcurrent release operation by means of advance of the release operation pushbutton. The circuit-breaker can only be closed again by resetting the pushbutton in its normal position.

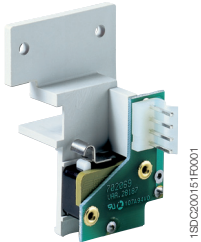

Contact signalling undervoltage release de-energised (Aux. contact YU)

The undervoltage release can be fitted with a contact (option normally closed or open) signalling undervoltage release energised for remote signalling of the state of the undervoltage release.



Trip reset

This is an electronic root device which allows remote resetting of the circuit-breaker following operation of the overcurrent releases. It is available with three power supply voltages: 24...30 V AC/DC, 110...130 V AC/DC and 200...240 V AC/DC.



Mechanical operation counter

This device is connected to the operating mechanism by means of a simple lever device. It indicates the number of mechanical operations of the circuit-breaker. The indication can be seen from the outside, on the front of the circuit-breaker.

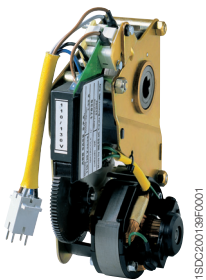

Spring charging motor

This automatically recharges the circuit-breaker operating mechanism closing springs. This operation is done automatically immediately after circuit-breaker closing.

When there is no power supply voltage, or during maintenance work, the closing springs can be charged manually by means of the operating mechanism lever. The motor is always provided with a limit contact and microswitch for signalling closing springs charged.

	AC [V]	DC [V]
Rated voltage, Un	24...30	24...30
	48...60	48...60
	100...130	100...130
	220...250	220...250
Operating voltage [% Un]	85...110	85...110
Power consumption on inrush	500 VA	500 W
Inrush time [s]	0.2	0.2
Charging time [s]	4-5	4-5



1SDC200158F0001



1SDC200157F0001



1SDC200168F0001



1SDC200168F0001

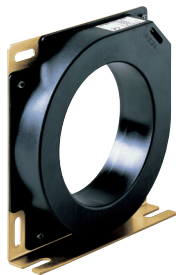

1SDC200154F0001



1SDC210D29F0001

Padlock in the open position

This allows the circuit-breaker to be locked in the open position by means of padlocks. A maximum of 3 padlocks (not supplied), with 4 mm \varnothing can be fitted.

Key lock in the open position

This allows the circuit-breaker to be locked in the open position by means of a circular lock with different keys (for an individual circuit-breaker) or with the same keys (for several circuit-breakers). In the latter case, up to four different key numbers are available. Preparation for a Ronis key lock is also available.

Transparent protection for pushbutton – TCP

A transparent protection for the circuit-breaker opening and closing pushbuttons is available on Tmax T8. The operations on the circuit-breaker are therefore prohibited except by means of a special tool.

IP54 Door protection

This is made by means of a transparent plastic cover which completely protects the front of the circuit-breaker and allows IP54 degree of protection to be obtained. Mounted on hinges, it is provided with a key lock.

Homopolar sensor for the main power supply earthing conductor (star centre of the transformer)

PR332/P electronic trip units can be used in combination with an external sensor located on the conductor, which connects the star centre of the MV/LV transformer (homopolar transformer) to earth. In this case, the earth protection is defined as Source Ground Return. Through two different combinations of connection of its terminals. The In of the same toroid can be set at 100 A, 250 A, 400 A, 800 A.

This is alternative to the homopolar toroid for residual current protection.

Homopolar toroid for residual current protection

The electronic PR332/P LSIRc trip units can be used combined with the homopolar toroid for residual current protection, which allows activation of the residual current protection.

This accessory, available only for three-pole Tmax T8 circuit-breakers, must be mounted on the busbars and is available in a single size up to 2500 A. This accessory is alternative to the homopolar sensor for the main power supply earthing conductor.

Accessories

Accessories for protection trip units

The protection trip units which equip the Tmax T8 circuit-breakers are in common with those available for the Tmax T7 size and therefore have the same characteristics and possibility of being fitted with accessories.

For further details, please consult the technical catalogue: "Tmax – Low Voltage moulded-case circuit-breakers up to 1600 A" (code 1SDC210015D0903).

The list of the modules and accessories which can be combined with the protection trip units for Tmax T8 is given below:

- PR330/V-T8 (optional on PR332/P)
- PR330/D-M (optional on PR332/P)
- PR330/R Actuation unit
- BT030 Wireless communication unit
- PR030/B Power supply unit
- HMI030 Interface from front of switchgear
- PR021/K Signalling unit
- PR010/T Programming and test unit.

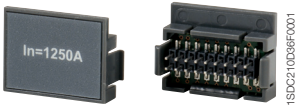

Rating plug

Available on the electronic trip units which can be mounted on Tmax T8, rating plug must be applied onto the front of the trip unit itself and provides information about the current sensor setting. It is therefore no longer necessary to change the circuit-breaker current sensors, but simply to replace the rating plug in order to modify the rated current of the circuit-breaker.

Type of circuit-breaker	Rated current I _n	I _n (A)					
		1000	1250	1600	2000	2500	3200
T8	2000	■	■	■	■		
	2500	■	■	■	■	■	
	3200	■	■	■	■	■	■

Current sensor for external neutral

This is applied onto the external neutral conductor and makes it possible to have the G protection against earth faults with three-pole circuit-breakers and external neutral. The current sensor must be connected directly to the terminal box. This combination is not possible with the PR232-T8 electronic trip unit.

T8
[A]
1000...3200

Characteristic curves and technical information

Trip curves

T8 2000/2500/3200 – PR232/P-T8

L-S-I Functions

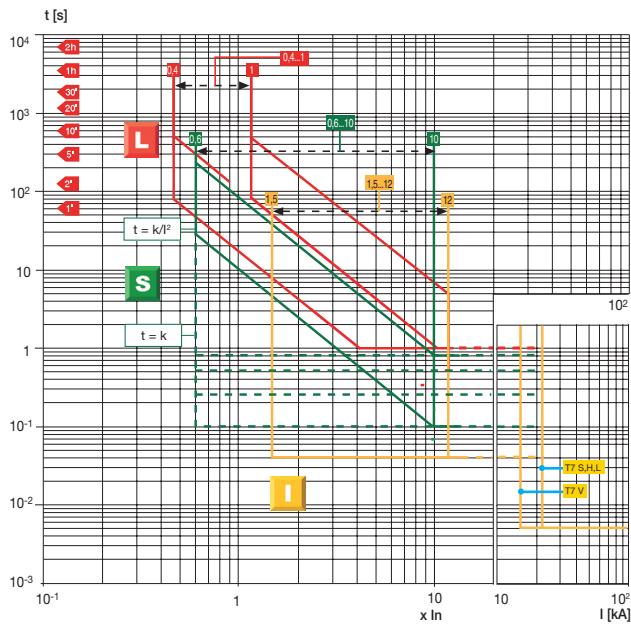

1SDC210039F0001

T8 2000/2500/3200 – PR331/P

L-S-I Functions

Note: For T8 In = 3200 A ⇒ I₃max = 12 x In

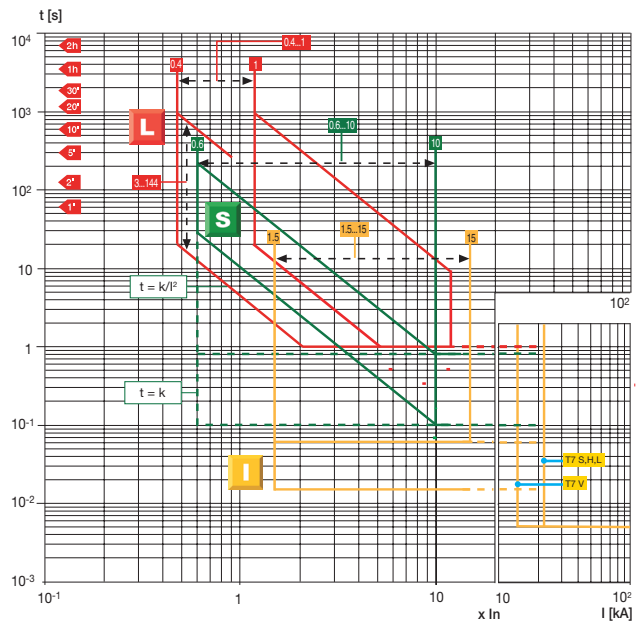

1SDC210031F0001

T8 2000/2500/3200 – PR331/P

G Function

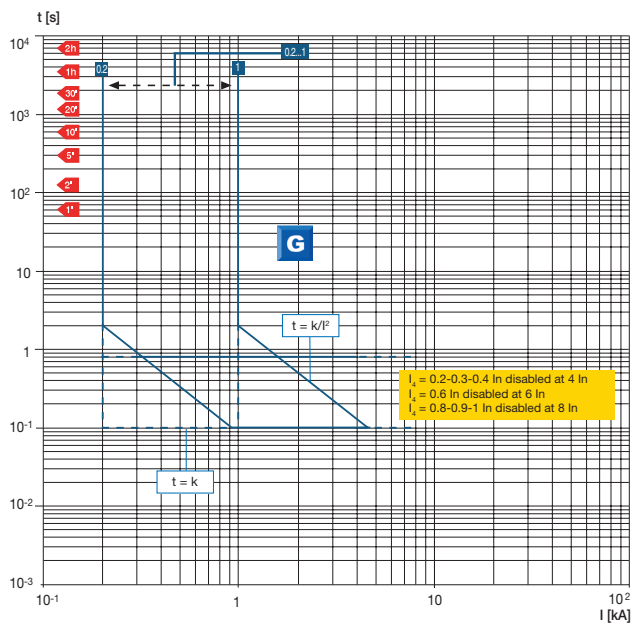

1SDC210039F0001

T8 2000/2500/3200 – PR332/P

L-I Functions

Note: For T8 In = 3200 A ⇒ I₃max = 12 x In

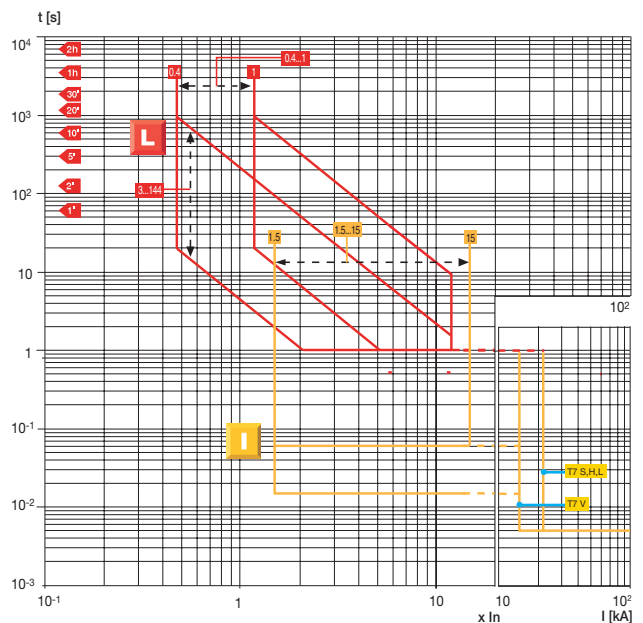

1SDC210039F0001

Characteristic curves and technical information

Trip curves

T8 2000/2500/3200 – PR332/P

L-S-I Functions

Note: For T8 $I_n = 3200 \text{ A} \Rightarrow I_{3\text{max}} = 12 \times I_n$

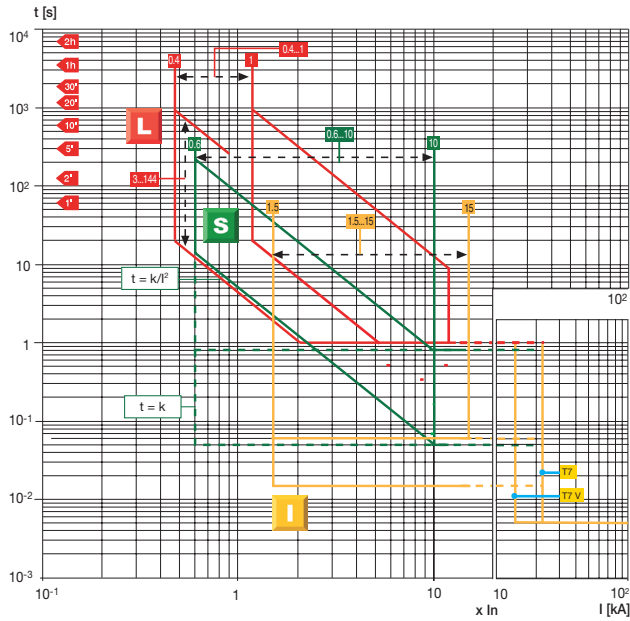

1SDC210639F0001

T8 2000/2500/3200 – PR332/P

G Function

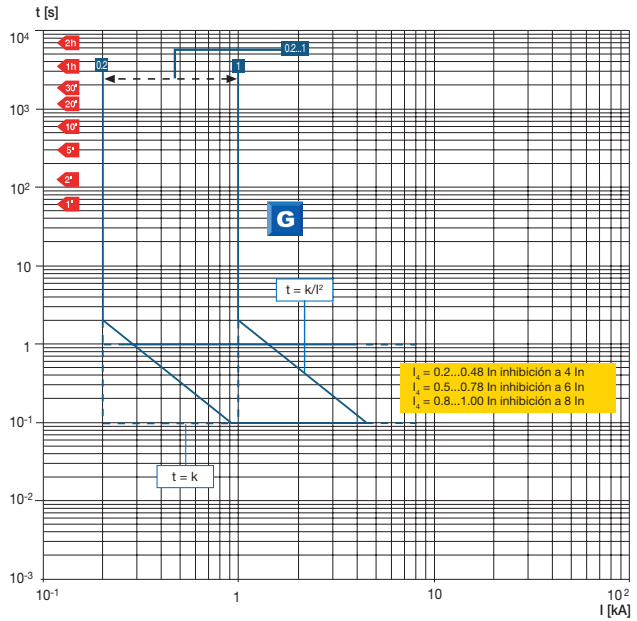

1SDC210639F0001

T8 2000/2500 – PR332/P

Rc Function

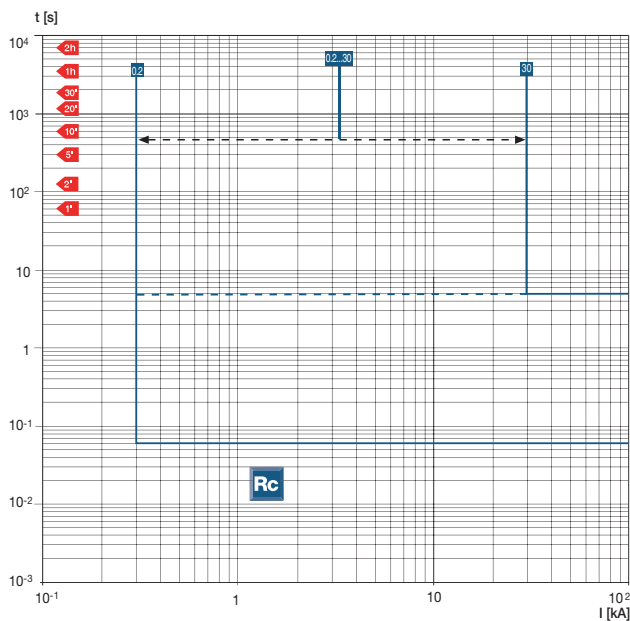

1SDC210639F0001

T8 2000/2500/3200 – PR332/P

L Function according to IEC 60255-3

$k = 0.14$ $\alpha = 0.02$

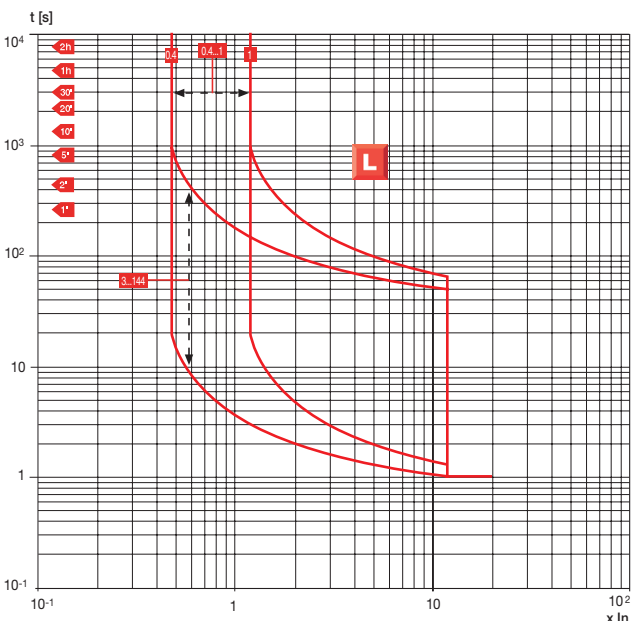

1SDC210639F0001

T8 2000/2500/3200 – PR332/P

L Function according to IEC 60255-3

$k = 13.5$ $\alpha = 1$

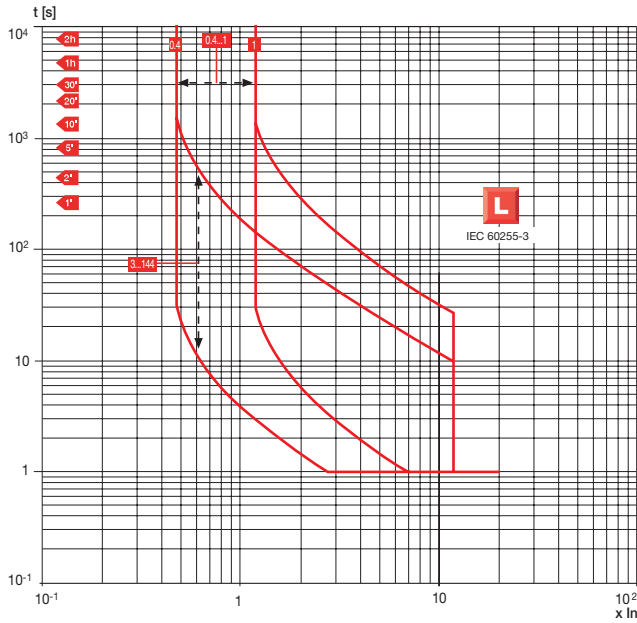

1SDC210F38F0001

T8 2000/2500/3200 – PR332/P

L Function according to IEC 60255-3

$k = 80$ $\alpha = 2$

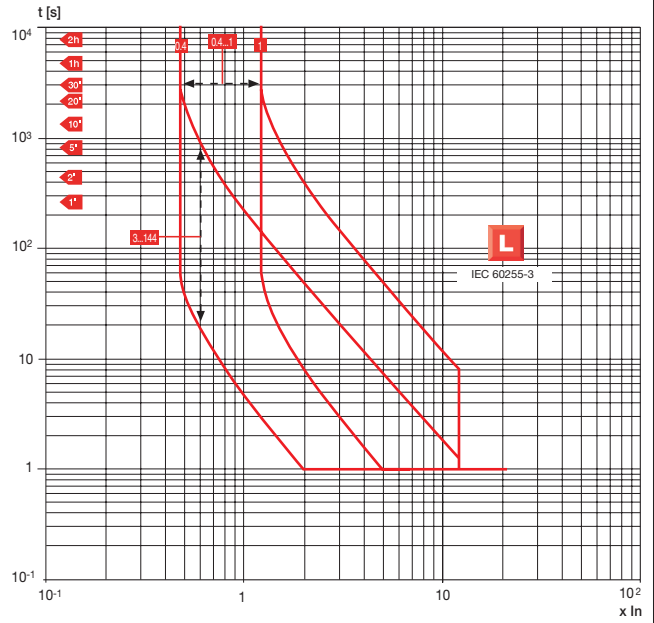

1SDC210F38F0001

T8 2000/2500/3200 – PR332/P

U Function

$k = 0.14$ $\alpha = 0.02$

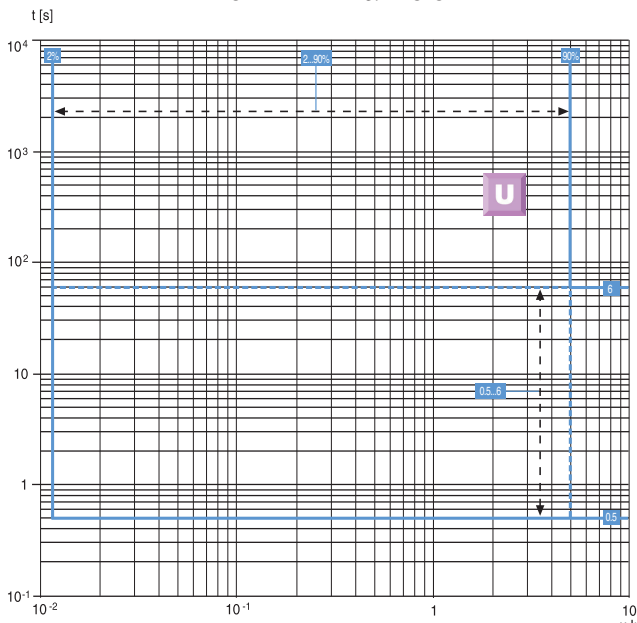

1SDC210F49F0001

**T8 2000/2500/3200
PR332/P with PR330/V-T8**

UV Function

$k = 13.5$ $\alpha = 1$

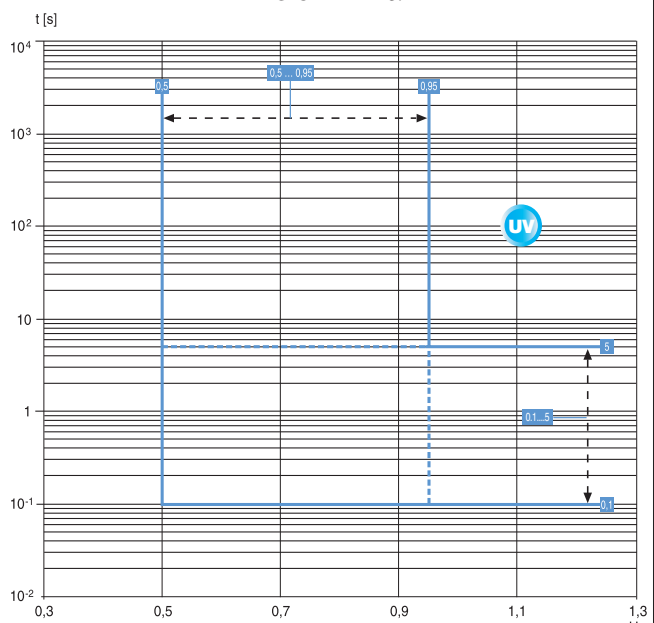

1SDC210F49F0001

Characteristic curves and technical information

Trip curves

T8 2000/2500/3200 PR332/P with PR330/V-T8

OV Function

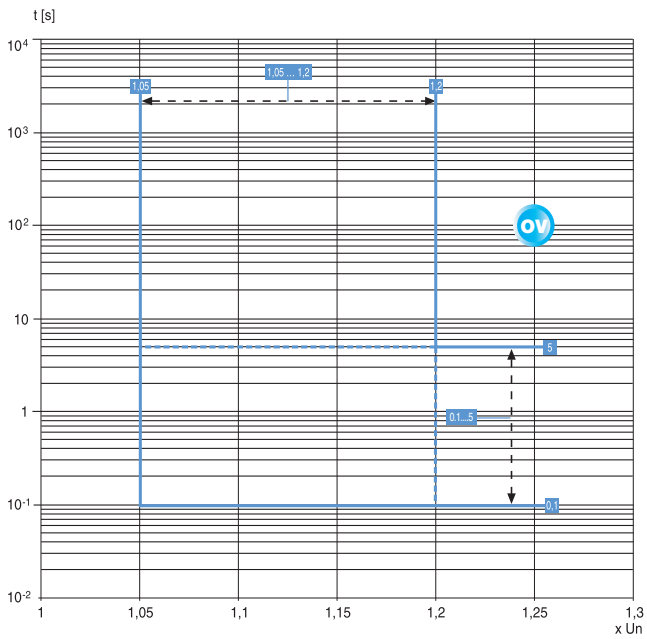

T8 2000/2500/3200 PR332/P with PR330/V-T8

RV Function

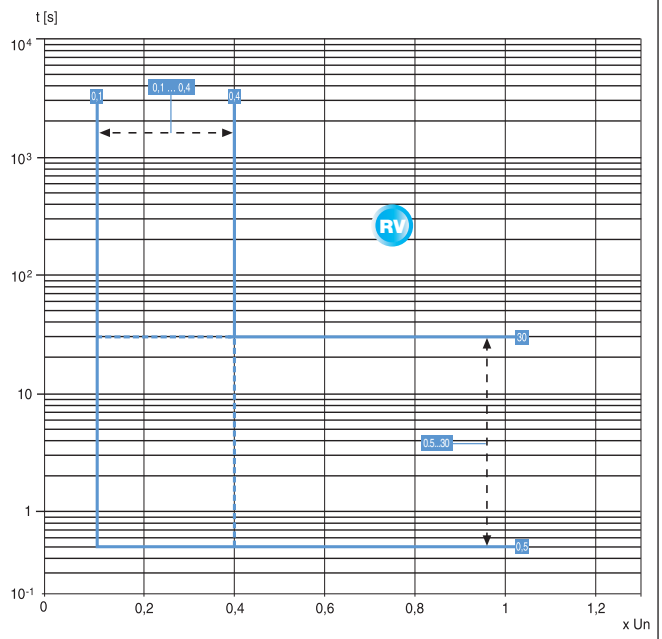

T8 2000/2500/3200 PR332/P with PR330/V-T8

RP Function

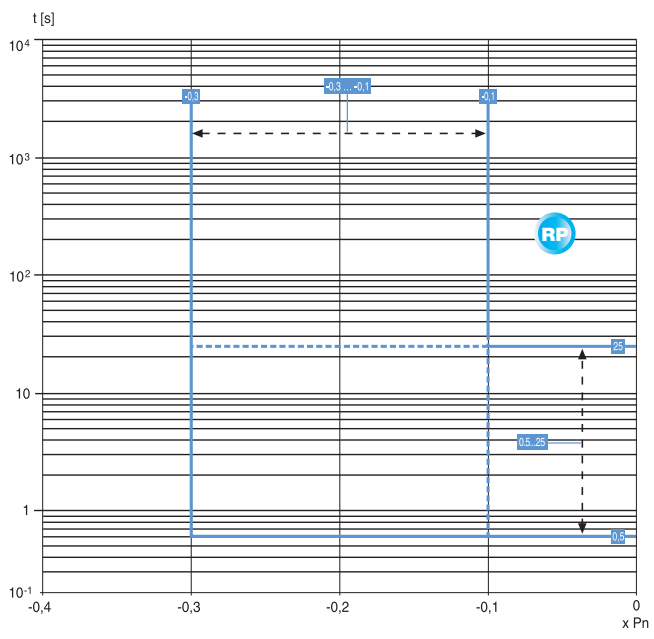

Characteristic curves and technical information

Specific let-through energy curves

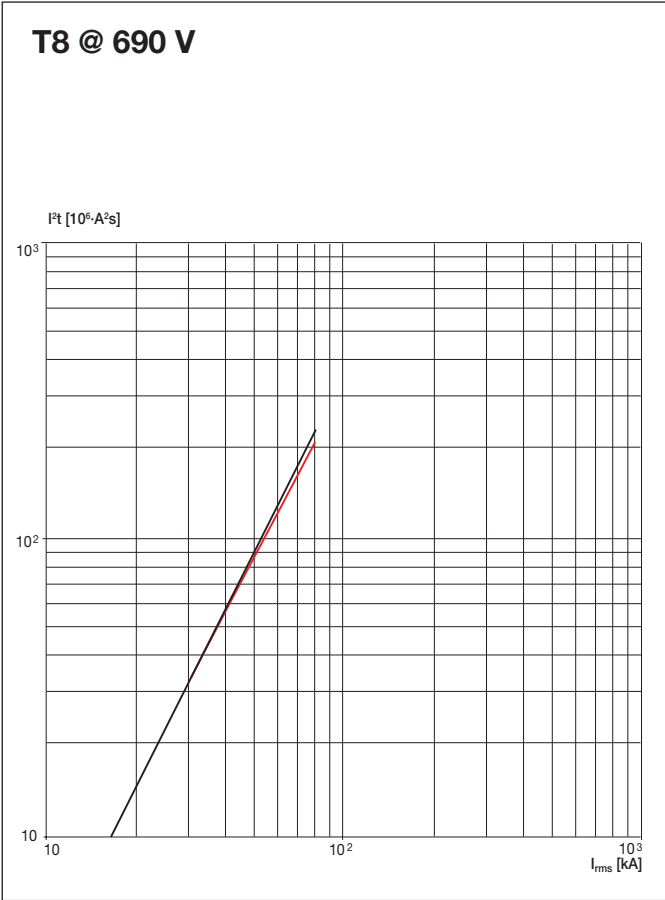
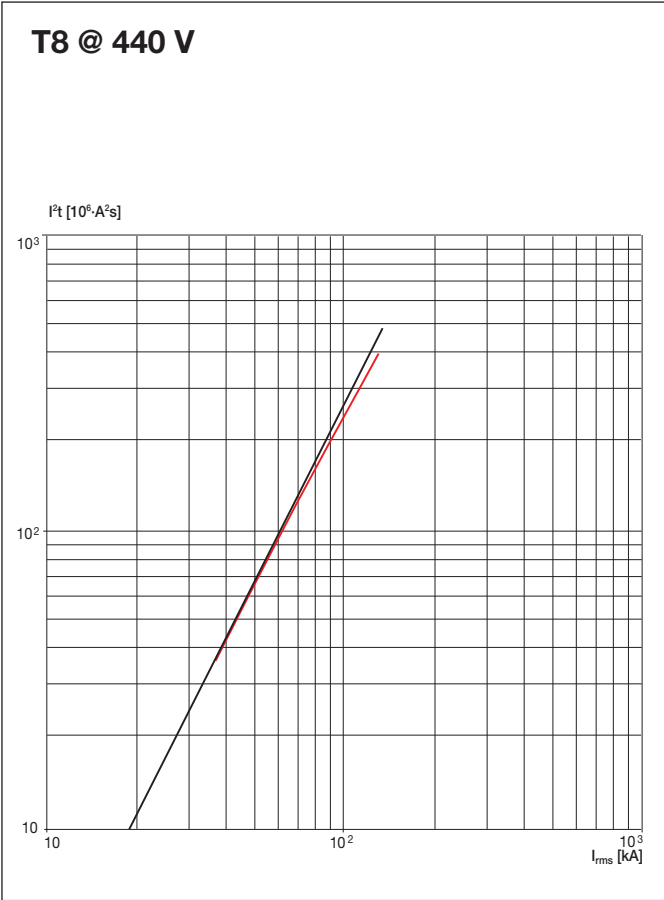

Characteristic curves and technical information

Limitation curves

T8 @ 440 V

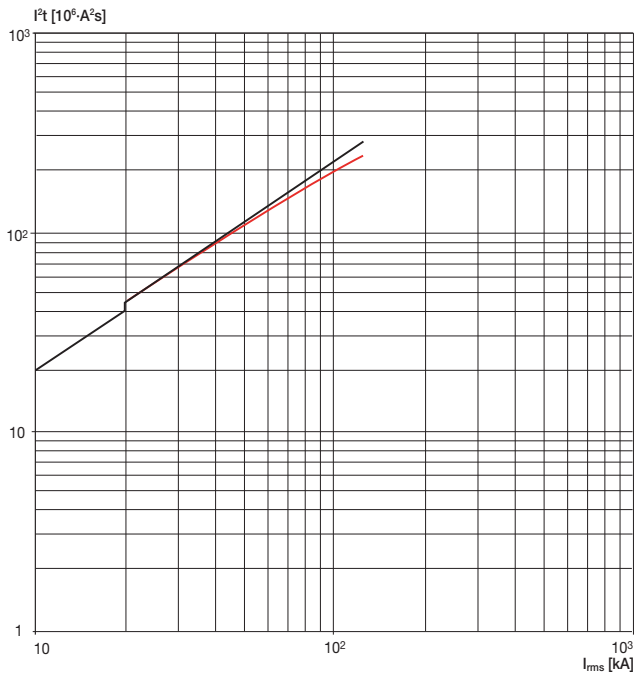

1SDC210027D0001

T8 @ 690 V

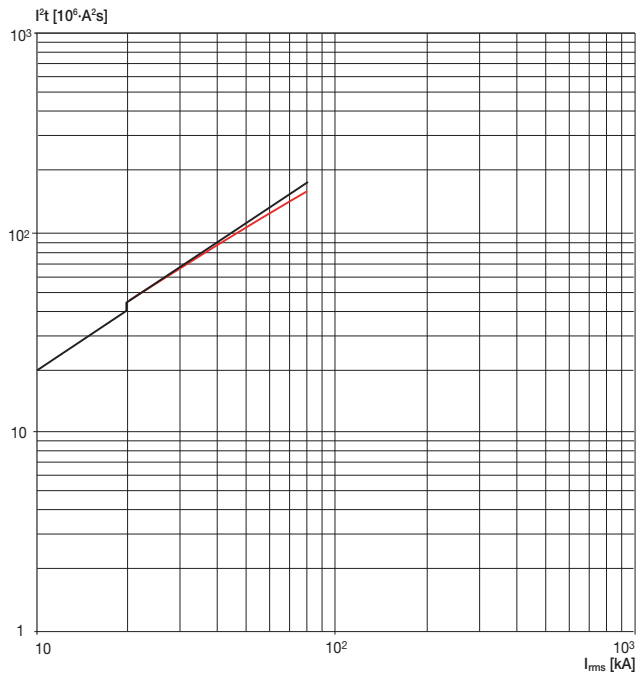

1SDC210027D0001

Characteristic curves and technical information

Temperature performances

T8 2000 with F and HR/VR terminals

	up to 40 °C		50 °C		60 °C		70 °C	
	I _{max} [A]	I ₁	I _{max} [A]	I ₁	I _{max} [A]	I ₁	I _{max} [A]	I ₁
VR	2000	1	2000	1	1907	0.95	1706	0.85
HR-F-ES	2000	1	2000	1	1826	0.91	1633	0.82

VR = Rear vertical flat terminals HR = Rear horizontal flat terminals F = Front flat terminals ES = Front extended spread terminals

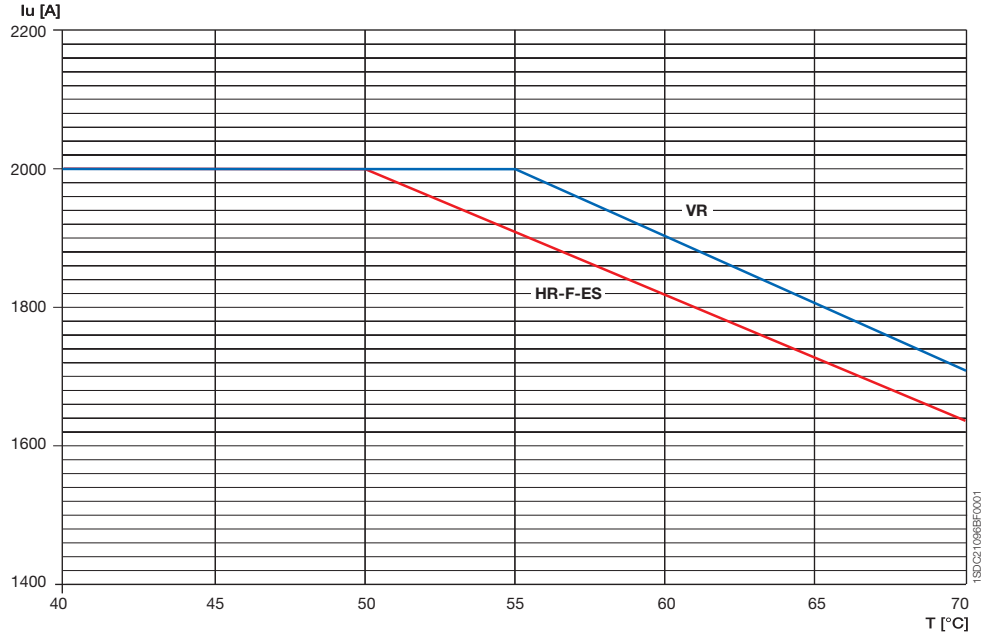

T8 2500 with F and HR/VR terminals

	up to 40 °C		50 °C		60 °C		70 °C	
	I _{max} [A]	I ₁	I _{max} [A]	I ₁	I _{max} [A]	I ₁	I _{max} [A]	I ₁
VR	2500	1	2500	1	2384	0.95	2133	0.85
HR-F-ES	2500	1	2500	1	2283	0.91	2042	0.82

VR = Rear vertical flat terminals HR = Rear horizontal flat terminals F = Front flat terminals ES = Front extended spread terminals

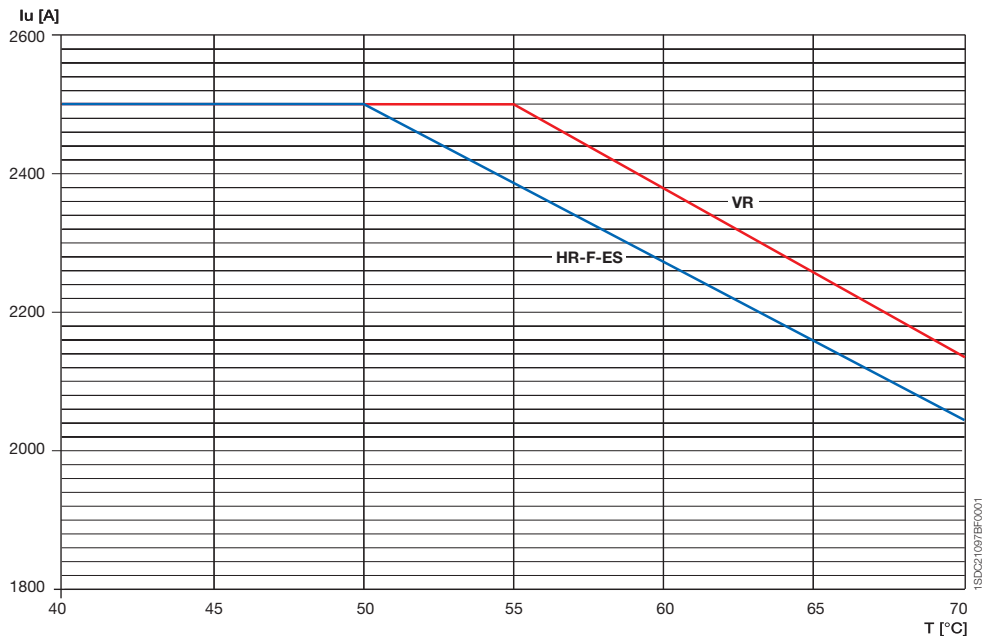

Characteristic curves and technical information

Temperature performances

T8 3200 with VR terminals

	up to 40 °C		50 °C		60 °C		70 °C	
VR	I _{max} [A]	I _r	I _{max} [A]	I _r	I _{max} [A]	I _r	I _{max} [A]	I _r
	3200	1	3200	1	2921	0.91	2613	0.82

VR = Rear vertical

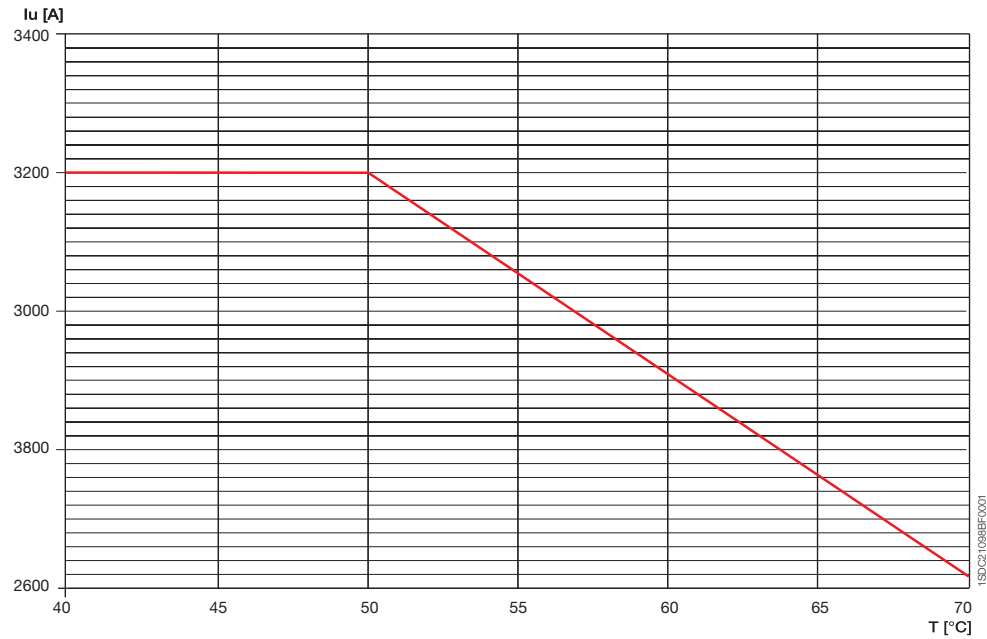

1SDC210027D0201

Characteristic curves and technical information

Power losses

Power [W/pole]	T8	
	In (A)	F
PR232/P-T8	2000	46
PR331/P	2500	73
PR332/P	3200	117

Magnetic trip values

	Trip unit	In [A]	I ₃ [A]	Single-phase trip current (% I ₃) ⁽¹⁾
T8 2000/2500/3200	PR232/P-T8	1000...3200	1.5...12 x In	100%
	PR331/P-PR332/P	1000...3200	1.5...15 x In ⁽²⁾	100%

⁽¹⁾ Satisfies the requirements of the IEC 60947-2 Standard, section 8.3.3.1.2

⁽²⁾ For In = 3200 A the maximum setting available is 12 In

Wiring diagrams

Information for reading - Circuit-breakers T8

Warning

Before installing the circuit-breaker, carefully read notes F and O on the circuit diagrams.

Operating status shown

The circuit diagram is for the following conditions:

- circuit-breaker in open position
- circuits de-energized
- trip units not tripped
- motor operating mechanism with springs discharged.

Versions

The control circuits are fitted between terminals XV (connectors X12-X13-X14-X15 are not supplied).

Version without overcurrent release

With this version, the applications indicated in figures 13, 14, 41A, 42A, 43A, 44A, 45A, 62A cannot be provided.

Version with PR232/P-T8 electronic trip unit

With this version, the applications indicated in figures 41A, 42A, 43A, 44A, 45A, 62A cannot be provided.

Version with PR331/P electronic trip unit

With this version, the applications indicated in figures 42A, 43A, 44A, 45A cannot be provided.

Version with PR332/P electronic trip unit

With this version, the applications indicated in figure 41A cannot be provided.

Caption

□	=	Circuit diagram figure number
*	=	See note indicated by letter
A1	=	Circuit-breaker accessories
A4	=	Example switchgear and connections for control and signalling, outside the circuit-breaker
A13	=	PR021/K signalling unit (outside the circuit-breaker)
A19	=	PR330/R actuation unit
AY	=	SOR TEST UNIT Test/monitoring Unit (see note R)
D	=	Electronic time-delay device of the undervoltage release, outside the circuit-breaker
K51	=	PR231/P, PR232/P-T8, PR331/P, PR332/P type electronic trip unit with the following protection functions: <ul style="list-style-type: none">– L overload protection with inverse long time-delay trip - setting I_1– S short-circuit protection with inverse or definite short time-delay trip - setting I_2– I short-circuit protection with instantaneous time-delay trip - setting I_3– G ground fault protection with inverse short time-delay trip - setting I_4
K51/1...8	=	Contacts of the PR021/K signaling unit
K51/GZin (DBin)	=	Zone selectivity: input for protection G or “reverse” direction input for protection D (only with Uaux. and PR332/P trip unit)
K51/GZout (DBout)	=	Zone selectivity: output for protection G or “reverse” direction output for protection D (only with and PR332/P trip unit)
K51/SZin (DFin)	=	Zone selectivity: input for protection S or “direct” input for protection D (only with Uaux. and PR332/P trip unit)
K51/SZout (DFout)	=	Zone selectivity: output for protection S or “direct” output for protection D (only with Uaux. and PR332/P trip unit)

K51/YC	= Closing control from PR332/P electronic trip unit with communication module PR330/D-M and PR330/R actuation unit
K51/YO	= Opening control from PR332/P electronic trip unit with communication module PR330/D-M and PR330/R actuation unit
M	= Motor for charging the closing springs
Q	= Circuit-breaker
Q/1...6	= Circuit-breaker auxiliary contacts
S33M/1...3	= Limit contacts for spring-charging motor
S4/1-2-3	= Contacts activated by the rotary handle of the circuit-breaker – only for circuit-breakers with manual control (see note C)
S43	= Switch for setting remote/local control
S51	= Contact for electrical signaling of circuit-breaker open due to tripping of the overcurrent trip unit. The circuit-breaker may be closed only after pressing the reset pushbutton, or after energizing the coil for electrical reset (if available)
S51/P1	= Programmable contact (as default it signals overload present - start)
SC	= Pushbutton or contact for closing the circuit-breaker
SO	= Pushbutton or contact for opening the circuit-breaker
SO1	= Pushbutton or contact for opening the circuit-breaker with delayed trip
SO2	= Pushbutton or contact for opening the circuit-breaker with instantaneous trip
SR	= Pushbutton or contact for electrical circuit-breaker reset
SRTC	= Contact for electrical signaling of circuit-breaker open, with springs charged and ready to close
SY	= Contact for electrical signaling of circuit-breaker open due to trip units tripped, YO, YO1, YO2, YU (tripped position) only for circuit-breakers with direct control
TI/L1	= Current transformer located on phase L1
TI/L2	= Current transformer located on phase L2
TI/L3	= Current transformer located on phase L3
Uaux.	= Auxiliary power supply voltage (see note F)
UI/L1	= Current sensor (Rogowski coil) located on phase L1
UI/L2	= Current sensor (Rogowski coil) located on phase L2
UI/L3	= Current sensor (Rogowski coil) located on phase L3
UI/N	= Current sensor (Rogowski coil) located on neutral
UI/O	= Current sensor (Rogowski coil) located on the conductor connecting to earth the star point of the MV/LV transformer (see note G)
W1	= Serial interface with control system (external bus): EIA RS485 interface (see note E)
W2	= Serial interface with the accessories of PR331/P and PR332/P trip units (internal bus)
XB1...XB7	= Connectors for the accessories of the circuit-breaker
XF	= Delivery terminal box for the position contacts of the withdrawable circuit-breaker (located on the fixed part of the circuit-breaker)
XO	= Connector for YO1 release
XR1 – XR2	= Connector for power circuits of PR232/P-T8, PR331/P, and PR332/P trip units
XR5 – XR13	= Connector for power circuits of PR332/P trip unit
XV	= Delivery terminal box for the auxiliary circuits of the fixed circuit-breaker
YC	= Shunt closing release
YO	= Shunt opening release
YO1	= Overcurrent shunt opening release (trip coil)
YO2	= Second shunt opening release (see note Q)
YR	= Coil to electrically reset the circuit-breaker
YU	= Undervoltage release (see notes B, C and Q)

Wiring diagrams

Information for reading - Circuit-breakers T8

Description of figures

- Fig. 1 = Motor circuit to charge the closing springs.
- Fig. 2 = Circuit of shunt closing release.
- Fig. 4 = Shunt opening release.
- Fig. 6 = Instantaneous undervoltage release (see notes B, C and Q).
- Fig. 7 = Undervoltage release with electronic time-delay device, outside the circuit-breaker (see notes B and Q).
- Fig. 8 = Second shunt opening release (see note Q).
- Fig. 11 = Contact for electrical signalling of springs charged or discharged.
- Fig. 12 = Contact for electrical signalling of circuit-breaker open, with springs charged, and ready to close.
- Fig. 13 = Contact for electrical signalling of circuit-breaker open due to tripping of the over-current release. The circuit-breaker may be closed only after pressing the reset pushbutton, or after energizing the coil for electronic reset (if available).
- Fig. 14 = Electrical reset control.
- Fig. 21 = Circuit-breaker auxiliary contacts (for circuit-breakers with manual control only).
- Fig. 41A = Auxiliary circuits of PR331/P trip unit (see note F).
- Fig. 42A = Auxiliary circuits of PR332/P trip units (see notes F and N).
- Fig. 43A = Circuits of the measuring module PR330/V-T8 of the PR332/P trip units internally connected to the circuit-breaker (optional).
- Fig. 44A = Circuits of the measuring module PR330/V-T8 of the PR332/P trip units externally connected to the circuit-breaker (optional; see note O).
- Fig. 45A = Circuits of the PR332/P trip unit with communication module PR330/D-M connected to PR330/V actuation unit (see notes E, F and N).
- Fig. 46A = Circuits of the PR332/P trip unit PR330/V-T8 measuring module connected internally to the three-pole circuit-breaker with external neutral conductor (optional).
- Fig. 61A = SOR TEST UNIT Test/monitoring unit (see note R).
- Fig. 62A = Circuits of the PR021/K signalling module (outside the circuit-breaker).

Incompatibilities

The circuits indicated in the following figures cannot be supplied simultaneously on the same circuit-breaker:

- 6 - 7 - 8
- 13 - 14
- 41A - 42A - 45A
- 43A - 44A - 46A

Notes

- A) The circuit-breaker is only fitted with the accessories specified in the ABB order acknowledgement. Please contact your local sales organization.
- B) The undervoltage release is supplied for operation using a power supply branched on the supply side of the circuit-breaker or from an independent source. The circuit-breaker can only close when the trip unit is energized (there is a mechanical lock on closing).
- E) For the EIA RS485 serial interface connection see document ITSCE - RH0298 regarding MODBUS communication
- F) The auxiliary voltage U_{aux} allows actuation of all operations of the PR331/P and PR332/P trip units. Having requested a U_{aux} insulated from earth, one must use "galvanically separated converters" in compliance with IEC 60950 (UL 1950) or equivalent standards that ensure a common mode current or leakage current (see IEC 478/1, CEI 22/3) not greater than 3.5 mA, IEC 60364-41 and CEI 64-8.
- G) Earth fault protection is available with the PR332/P trip units by means of a current sensor located on the conductor connecting to earth the star center of the MV/LV transformer. The connections between terminals 1 and 2 (or 3) of current transformer UI/O and poles T7 and T8 of the X (or XV) connector must be made with a two pole shielded and stranded cable (type BELDEN 8762/8772), no more than 15 m long. The shield must be earthed on the circuit-breaker side and current sensor side.

-
-
- N) With PR332/P trip units, the connections to the zone discrimination inputs and outputs must be made with a two-pole shielded and stranded cable (type BELDEN 8762/8772), no more than 300 m long. The shield must be earthed on the discrimination input side.
- O) Systems with rated voltage greater than 690V require the use of an insulation voltage transformer to connect to the busbars.
- P) With PR332/P trip units with communication module PR330/R, the power supply for coils YO and YC must not be taken from the main power supply. The coils can be controlled directly from contacts K51/YO and K51/ YC with maximum voltages of 110-120 V DC and 240-250 V AC.
- Q) The second shunt opening release may be installed as an alternative to the undervoltage release.
- R) The SOR TEST UNIT + shunt opening release (YO) is guaranteed to operate starting at 75% of the U_{aux} of the shunt opening release itself.
While the YO power supply contact is closing (short-circuit on terminals 4 and 5), the SOR TEST UNIT is unable to detect the opening coil status. Consequently:
– for continuously powered opening coil, the TEST FAILED and ALARM signals will be activated
– if the coil opening command is of the pulsing type, the TEST FAILED signal may appear at the same time. In this case, the TEST FAILED signal is actually an alarm signal only if it remains lit for more than 20s.
- S) The connection cable shield must only be earthed on the circuit-breaker side.
- T) The connections between the TO toroidal transformer and the poles of the X13 (or XV) connector of the circuit-breaker must be made using a four-pole shielded cable with paired braided conductors (BELDEN 9696 paired type), with a length of not more than 15 m. The shield must be earthed on the circuit-breaker side.

Wiring diagrams

Graphic diagram symbols

(IEC 60617 and CEI 3-14...3-26 Standards)

	Thermal effect		Connection of conductors		Position switch (limit switch), break contact		Differential current relay
	Electromagnetic effect		Terminal		Position switch (limit switch) change-over break before make contact		Phase-failure detection relay in a three-phase system
	Delay		Plug and socket (male and female)		Contactor (contact open in the unoperated position)		Locked-rotor detection relay operating by current sensing
	Mechanical connection (link)		Resistor (general symbol)		Circuit-breaker disconnect with automatic trip unit		Lamp, general symbol
	Manually operated control (general case)		Temperature dependent resistor		Switch-disconnector (on-load isolating switch)		Mechanical interlock between two devices
	Operated by turning		Motor (general symbol)		Operating device (general symbol)		Operated by electric motor
	Operated by pushing		Induction motor, three-phase, squirrel cage		Thermal relay		Motor with series energization
	Operated by key		Current transformer		Instantaneous overcurrent or rate-of-rise relay		Screen, shield (it may be drawn in any convenient shape)
	Operated by cam		Current transformer with four threaded winding and with one permanent winding with one tapping		Overcurrent relay with adjustable short time-lag characteristic		Equipotentiality
	Earth, ground (general symbol)		Make contact		Overcurrent relay with inverse short time-lag characteristic		Voltage transformer
	Converter with galvanic separator		Break contact		Overcurrent relay with inverse long time-lag characteristic		Winding of three-phase transformer, connection star
	Conductors in a screened cable, two conductors shown		Change-over break before make contact		Earth fault overcurrent relay with inverse short time-lag characteristic		Current sensing element
	Twisted conductors, two conductors shown		Position switch (limit switch), make contact		Phase-balance current relay		

Wiring diagrams

Wiring diagram of the T8 circuit-breaker

Operating status

Four-pole circuit-breaker with PR232/P-T8, PR331/P, or PR332/P electronic trip unit

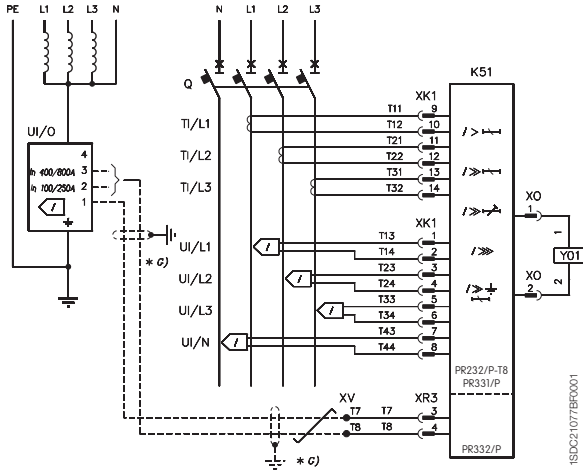

Three-pole circuit-breaker with PR232/P-T8, PR331/P or PR332/P electronic trip unit

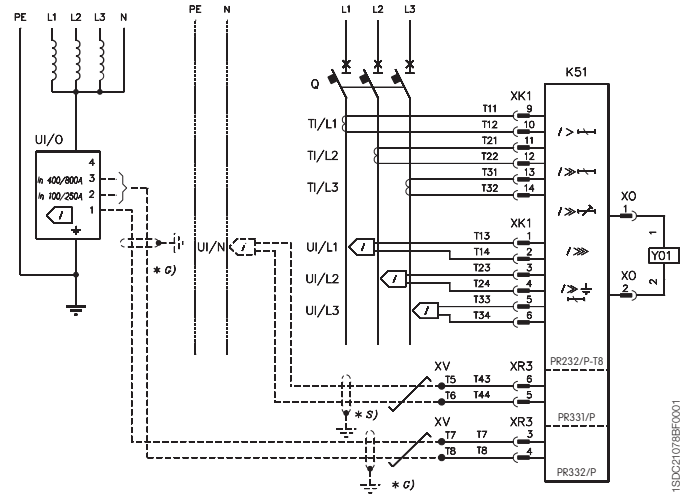

Three-pole circuit-breaker with PR332/P electronic trip unit, residual current protection and $U \leq 690$ V

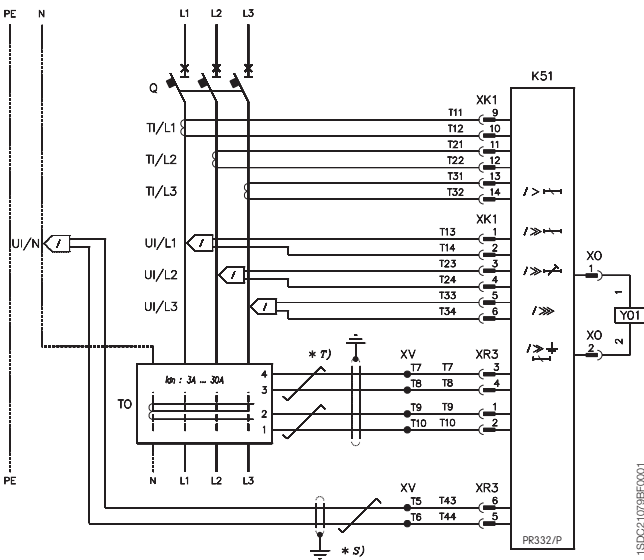

Three or four-pole switch-disconnector

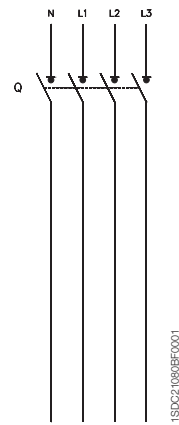

Wiring diagrams

Electrical accessories for T8

Motor operating mechanism, opening, closing and undervoltage releases

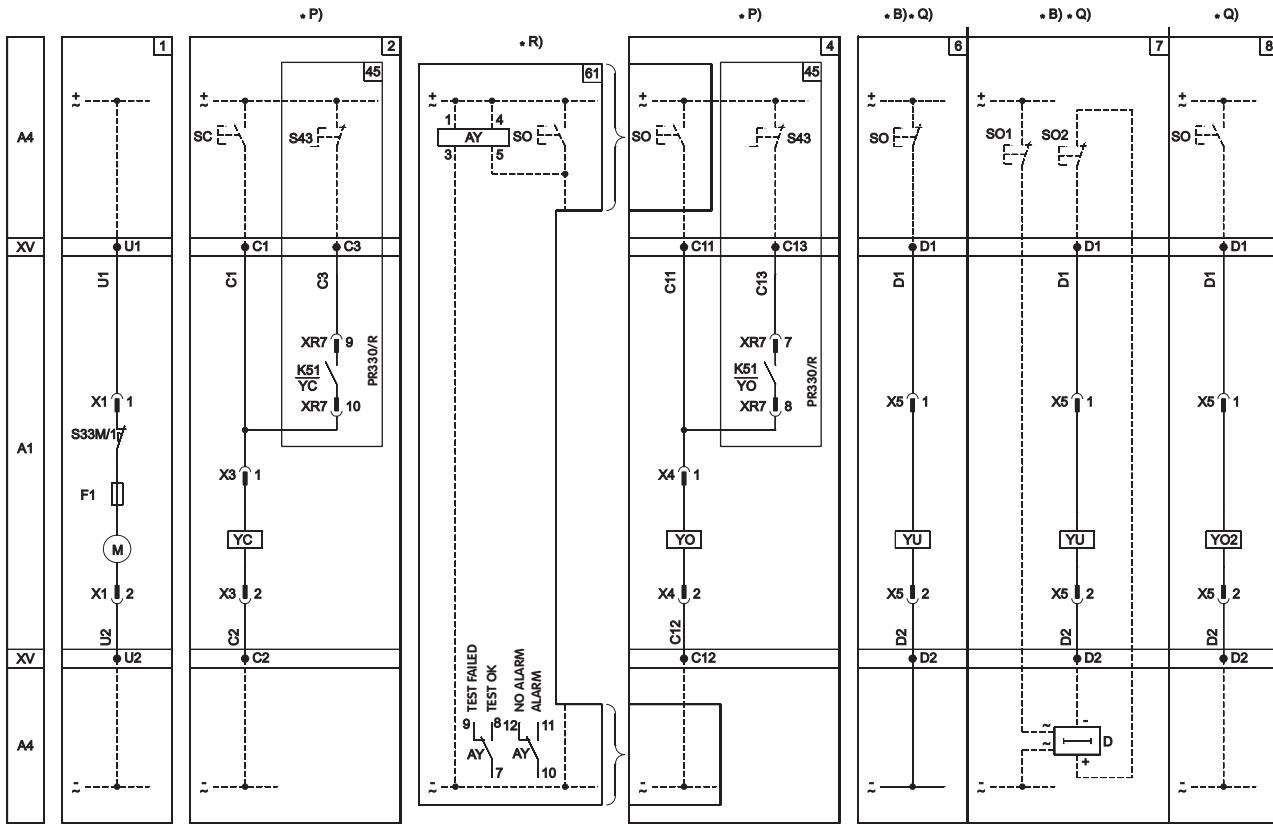

1SDC21061BF0001

Signalling contacts

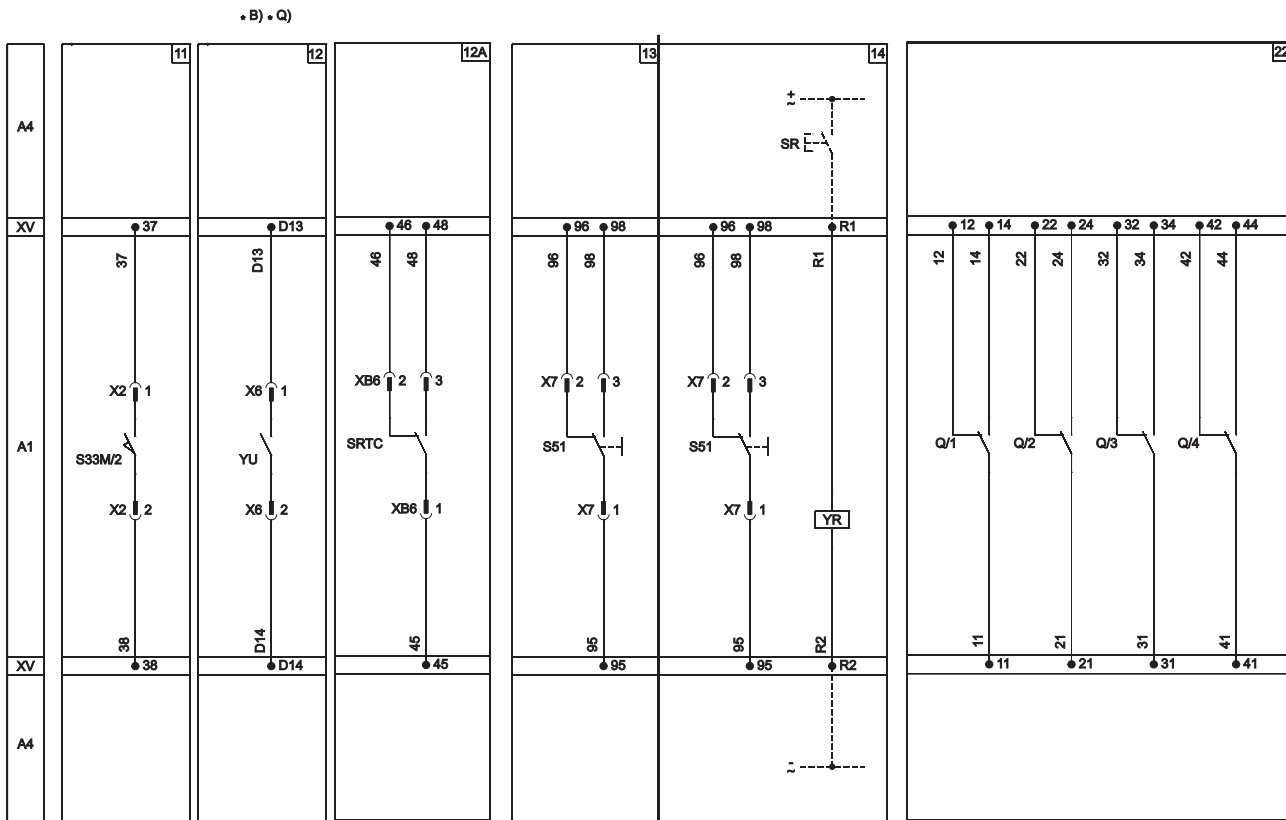

1SDC21062BF0001

Wiring diagrams

Electrical trip units for T8

Auxiliary circuits of the PR331 and PR332 releases

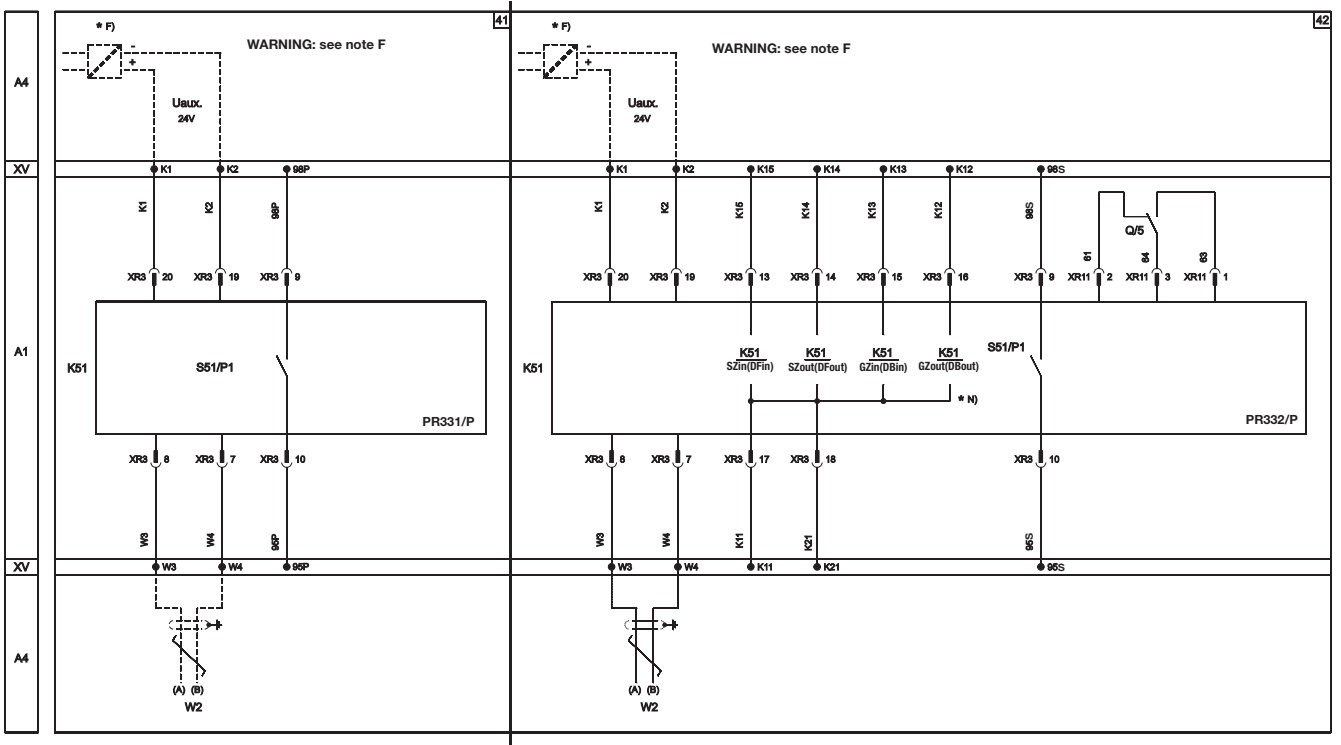

PR330/V-T8 measuring module

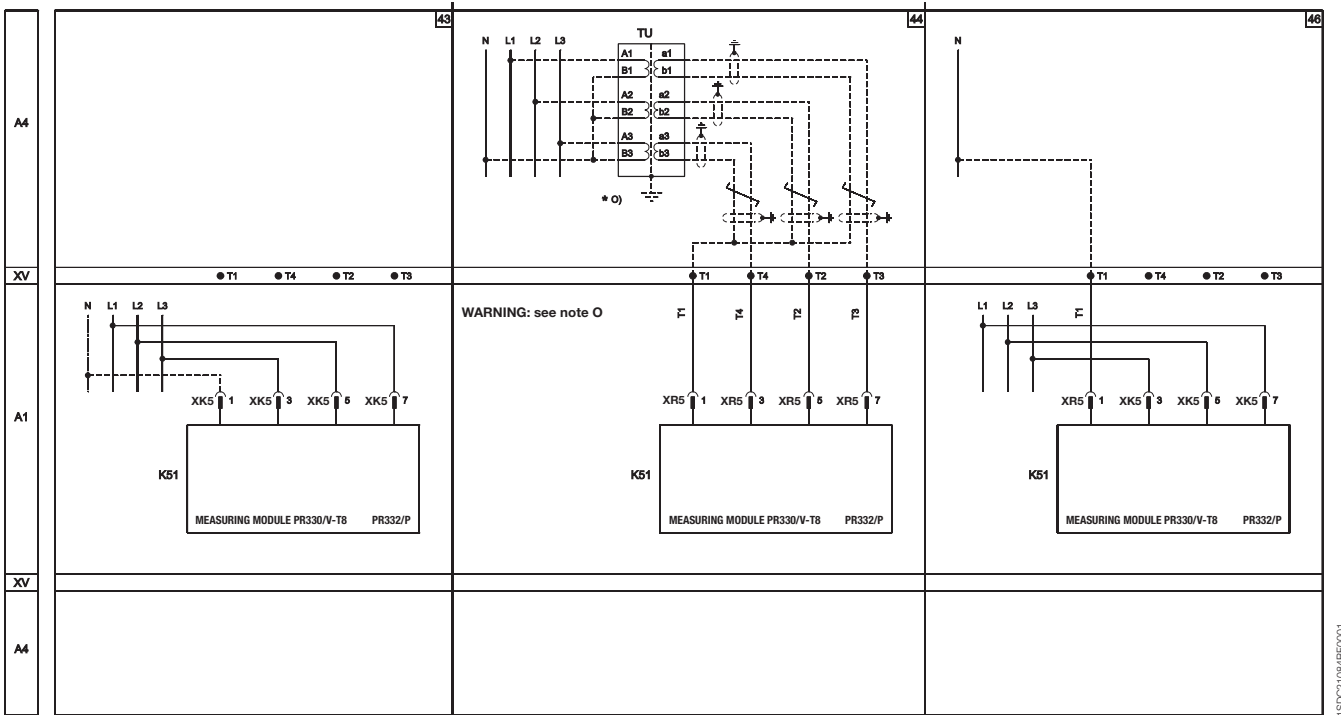

1SDC21083BF0001

1SDC21084BF0001

Wiring diagrams

Electrical trip units for T8

Auxiliary circuits of the PR332 trip unit with communication module PR330/D-M connected to actuation unit PR330/R

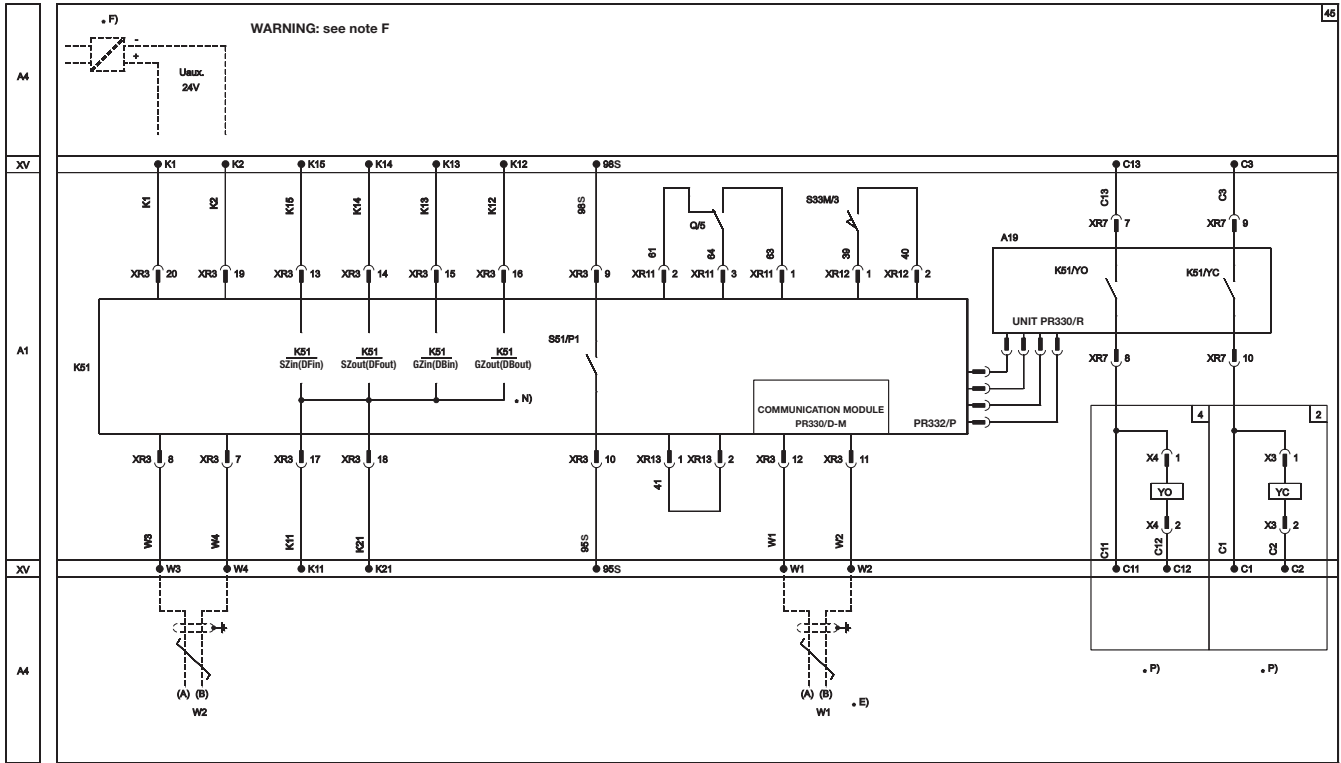

PR021/K signalling unit

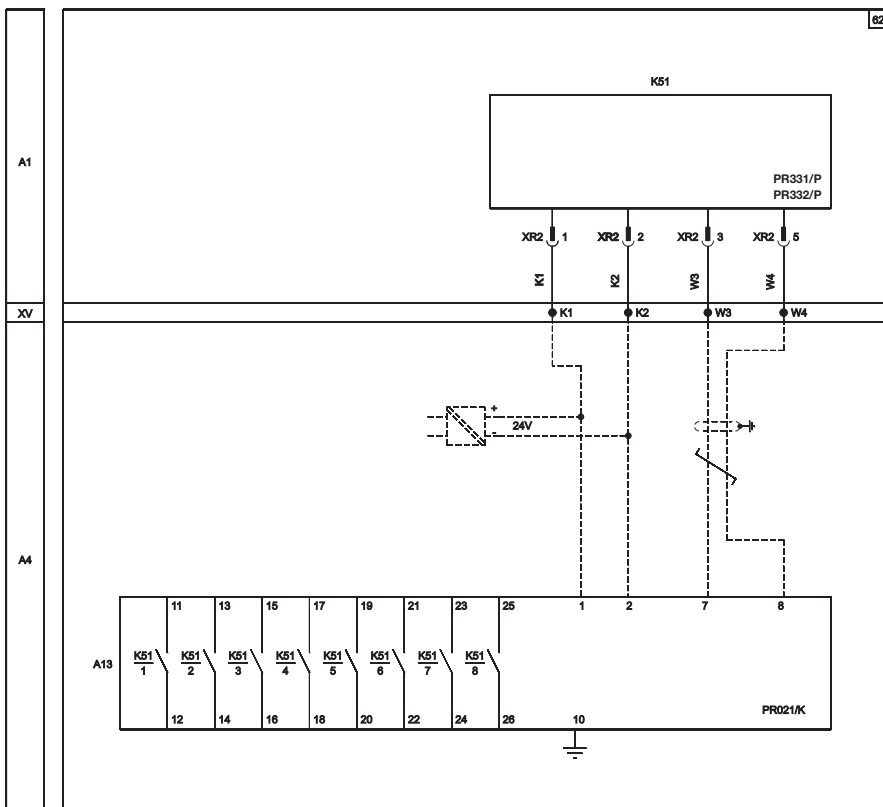

Overall dimensions

Tmax T8

Fixed circuit-breaker – 2000 A / 2500 A

Front terminals – F

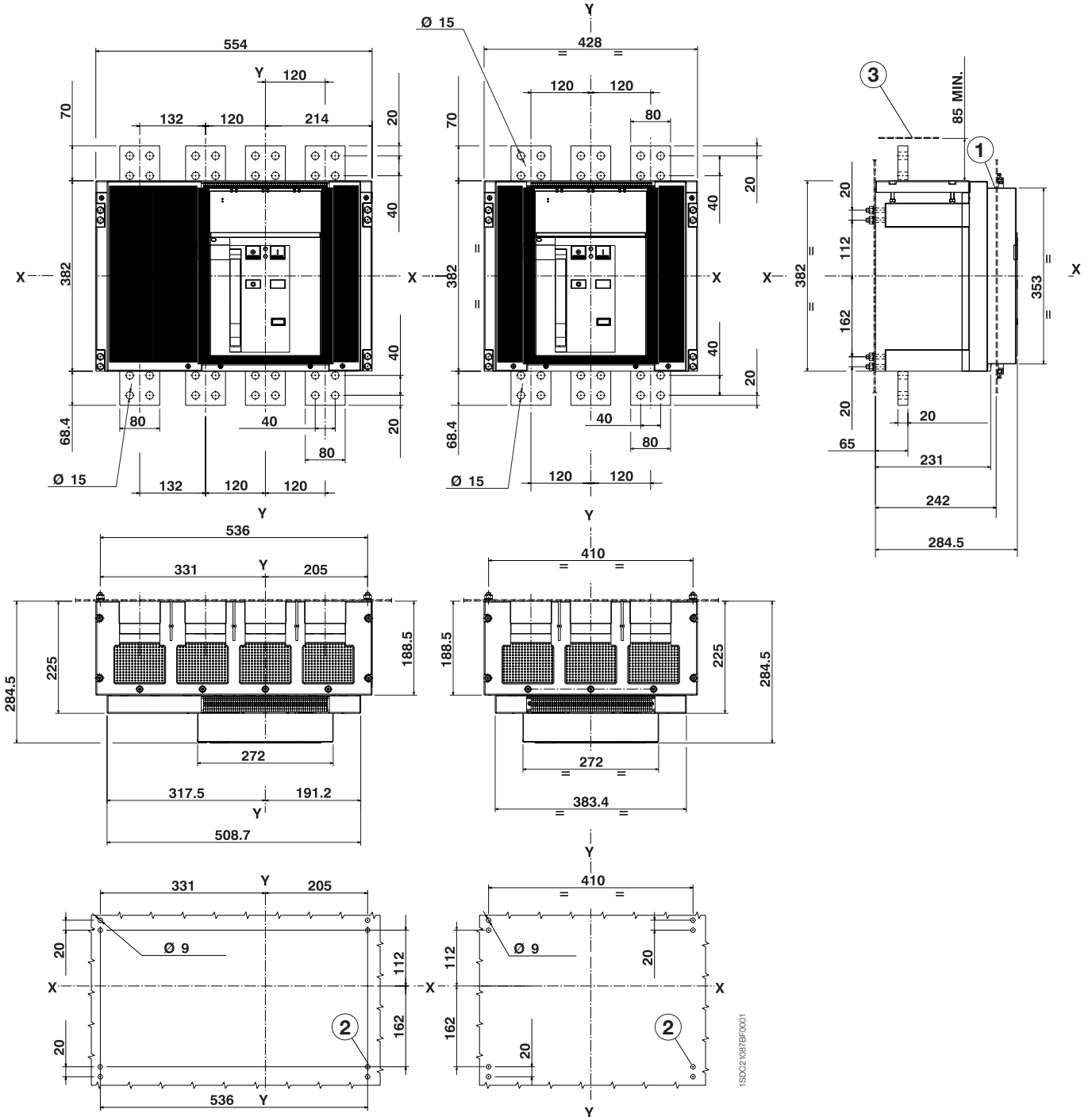

Caption

- ① Inside edge of compartment door
- ② Circuit-breaker M8 fixing drilling (use M8 screws)
- ③ Insulating or metal-insulated wall

Overall dimensions

Tmax T8

Fixed circuit-breaker – 2000 A / 2500 A

Front extended spread terminals – ES

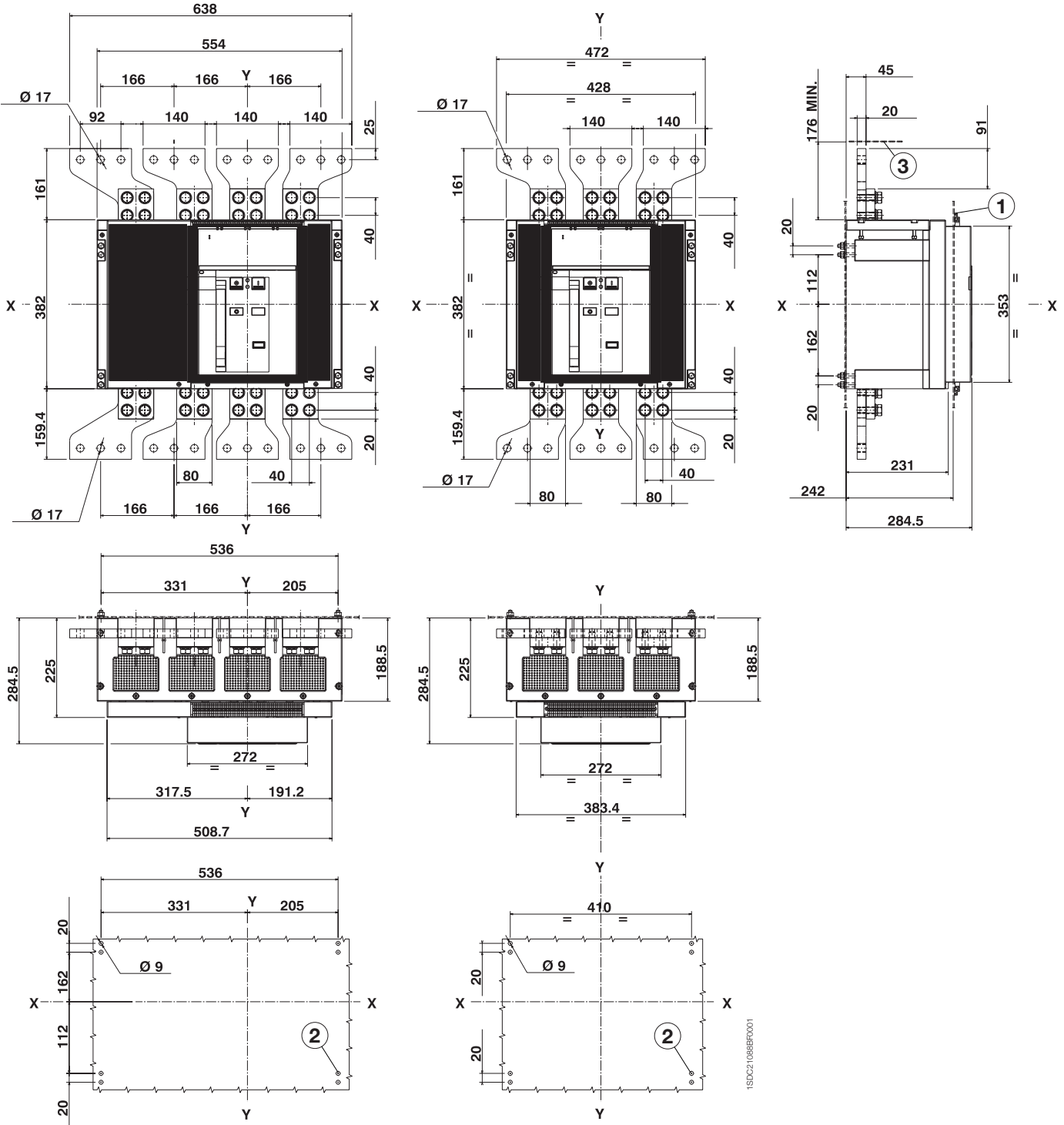

Caption

- ① Inside edge of compartment door
- ② Circuit-breaker M8 fixing drilling (use M8 screws)
- ③ Insulating or metal-insulated wall

Fixed circuit-breaker – 2000 A / 2500 A

Rear flat orientated terminals – HR/VR

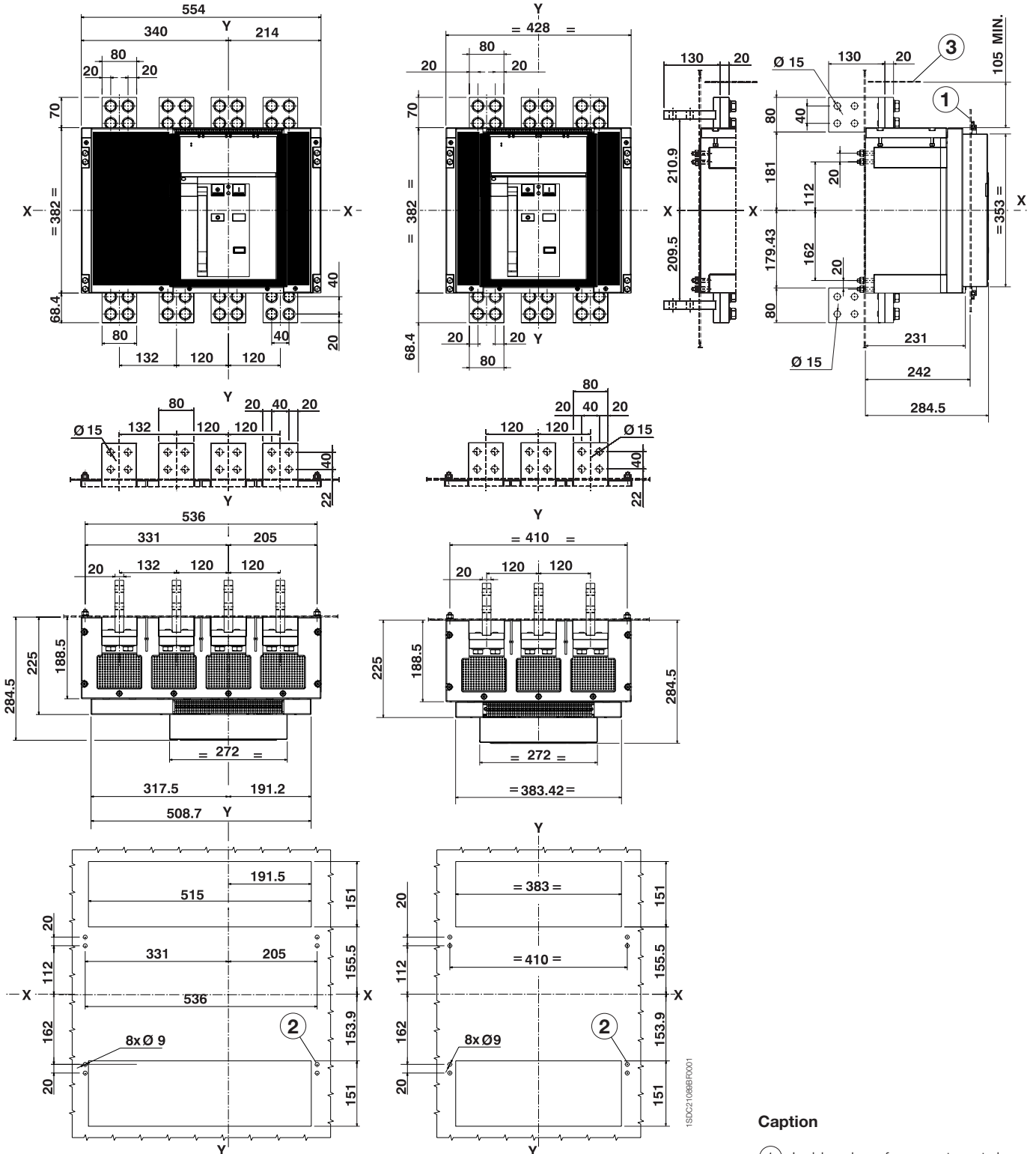

1SDC21088BF001

Caption

- ① Inside edge of compartment door
- ② Circuit-breaker M8 fixing drilling (use M8 screws)
- ③ Insulating or metal-insulated wall

Overall dimensions

Tmax T8

Fixed circuit-breaker – 3200 A

Rear vertical terminals – VR

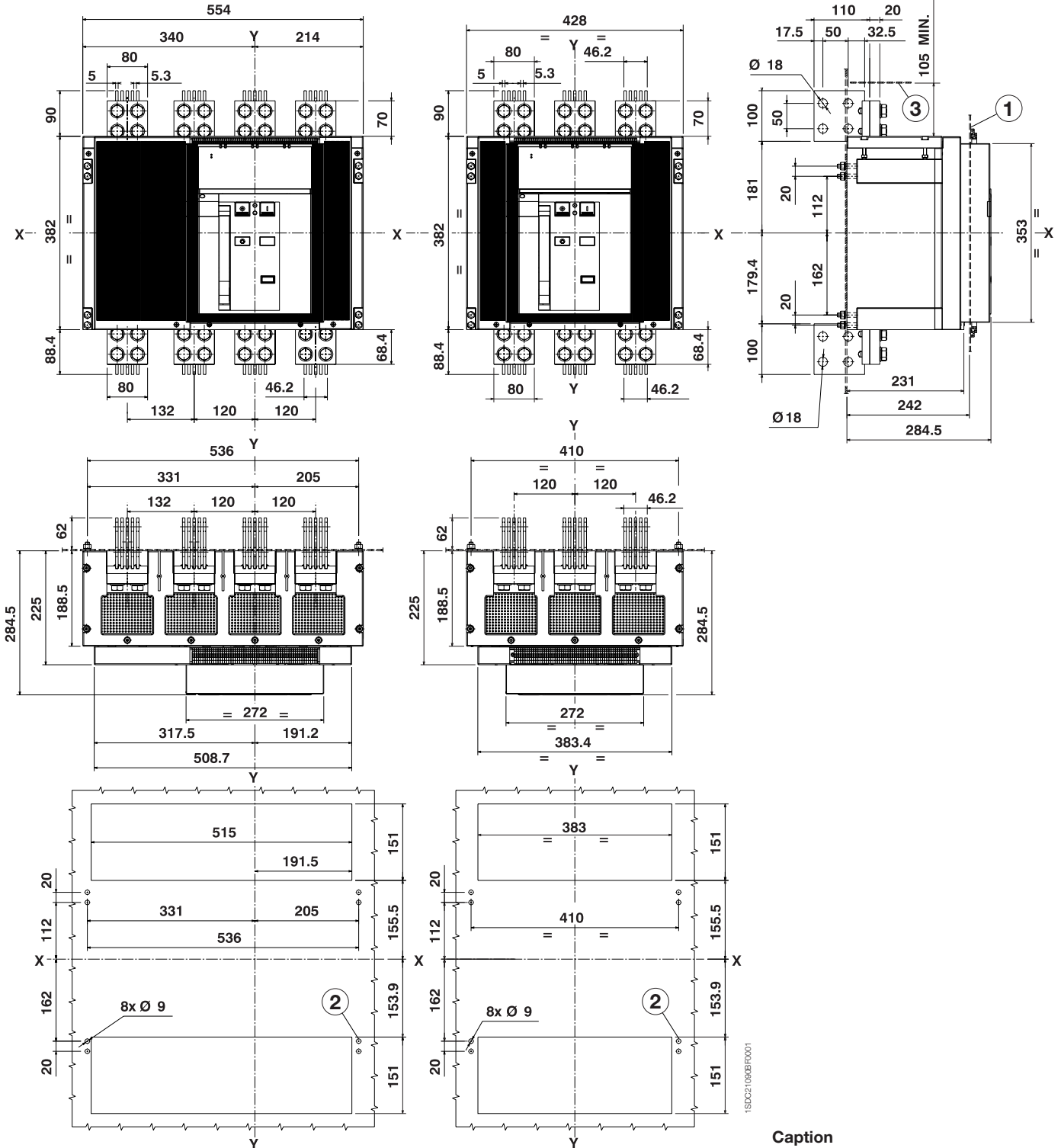

1SDC21062BF0001

Caption

- ① Inside edge of compartment door
- ② Circuit-breaker M8 fixing drilling (use M8 screws)
- ③ Insulating or metal-insulated wall

Compartment door drilling

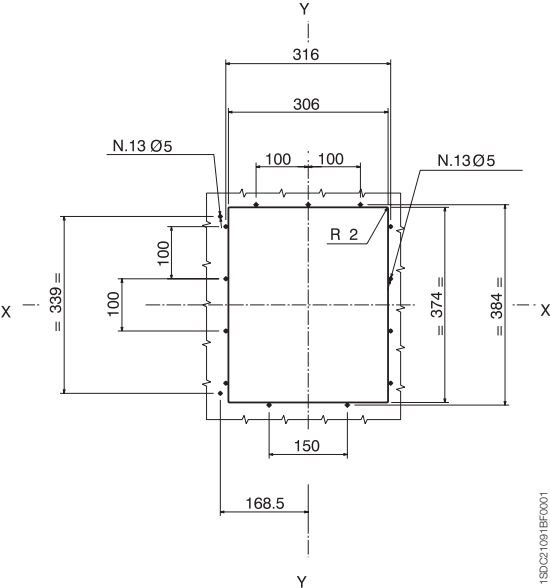

Overall dimensions

Distances to be respected

Insulation distances for installation in metallic cubicle

	A (mm)	B (mm)	C (mm)
T8	200	30	120

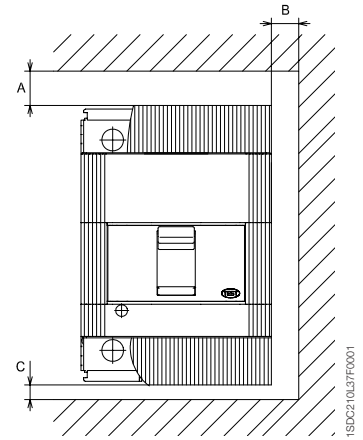

Minimum centre distance between two circuit-breakers side by side or superimposed

For assembly side by side or superimposed, check that the connection busbars or cables do not reduce the air insulation distance.

Minimum centre distance for two circuit-breakers side by side

	Circuit-breaker width (mm)		Centre distance I (mm)	
	3 Poles	4 Poles	3 Poles	4 Poles
T8	427	553	456	582

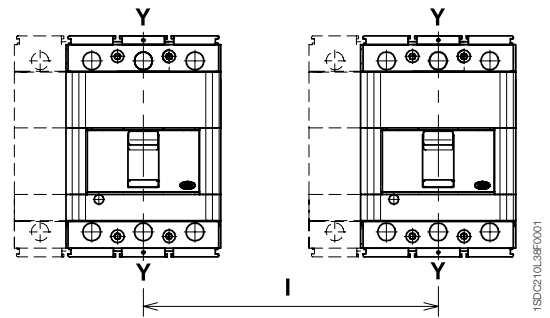

Minimum centre distance for superimposed circuit-breakers

	H (mm)
T8	300

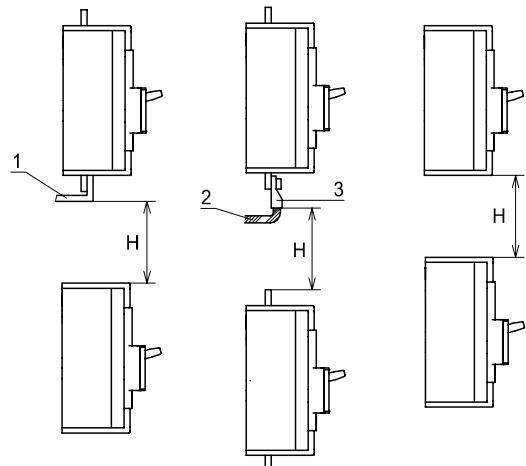

Caption

- ① Connection - not insulated
- ② Insulated cable
- ③ Cable terminal

Note: The dimensions shown apply for operating voltage U_b up to 690 V. The dimensions to be respected must be added to the maximum dimensions of the various different versions of the circuit breakers, including the terminals.

Ordering codes

Power distribution circuit-breakers

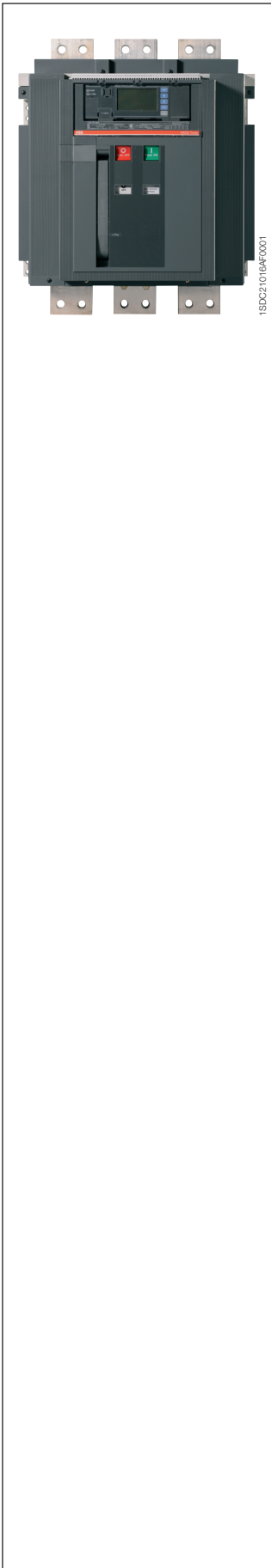

T8 2000 – Fixed (F) – I_n (40 °C) = 2000 A - 3 Poles - Front terminals (F)

<i>Electronic trip unit</i>	I _n	Icu (415 V)	1SDA R1	
			L	V
			85 kA	130 kA
PR232/P-T8 LSI	2000		065723	065769
PR331/P LSIg	2000		065724	065770
PR332/P LI	2000		065725	065771
PR332/P LSI	2000		065726	065772
PR332/P LSIg	2000		065727	065773
PR332/P LSIRc	2000		065728	065774

T8 2000 – Fixed (F) – I_n (40 °C) = 2000 A - 4 Poles - Front terminals (F)

<i>Electronic trip unit</i>	I _n	Icu (415 V)	1SDA R1	
			L	V
			85 kA	130 kA
PR232/P-T8 LSI	2000		065729	065775
PR331/P LSIg	2000		065730	065776
PR332/P LI	2000		065731	065777
PR332/P LSI	2000		065732	065778
PR332/P LSIg	2000		065733	065779

T8 2500 – Fixed (F) – I_n (40 °C) = 2500 A - 3 Poles - Front terminals (F)

<i>Electronic trip unit</i>	I _n	Icu (415 V)	1SDA R1	
			L	V
			85 kA	130 kA
PR232/P-T8 LSI	2500		065758	065780
PR331/P LSIg	2500		065759	065781
PR332/P LI	2500		065760	065782
PR332/P LSI	2500		065761	065783
PR332/P LSIg	2500		065762	065784
PR332/P LSIRc	2500		065763	065785

T8 2500 – Fixed (F) – I_n (40 °C) = 2500 A - 4 Poles - Front terminals (F)

<i>Electronic trip unit</i>	I _n	Icu (415 V)	1SDA R1	
			L	V
			85 kA	130 kA
PR232/P-T8 LSI	2500		065764	065786
PR331/P LSIg	2500		065765	065787
PR332/P LI	2500		065766	065788
PR332/P LSI	2500		065767	065789
PR332/P LSIg	2500		065768	065790

Ordering codes

Power distribution circuit-breakers



T8 3200 – Fixed (VR) – I_u (40 °C) = 3200 A - 3 Poles - Rear vertical terminals (VR)

<i>Electronic trip unit</i>	I _n	Icu (415 V)	1SDA R1	
			L	V
			85 kA	130 kA
PR232/P-T8 LSI	3200		065734	065791
PR331/P LSIG	3200		065735	065792
PR332/P LI	3200		065736	065793
PR332/P LSI	3200		065737	065794
PR332/P LSIG	3200		065738	065795

T8 3200 – Fixed (VR) – I_u (40 °C) = 3200 A - 4 Poles - Rear vertical terminals (VR)

<i>Electronic trip unit</i>	I _n	Icu (415 V)	1SDA R1	
			L	V
			85 kA	130 kA
PR232/P-T8 LSI	3200		065739	065796
PR331/P LSIG	3200		065740	065797
PR332/P LI	3200		065741	065798
PR332/P LSI	3200		065742	065799
PR332/P LSIG	3200		065743	065800

Ordering codes

Switch disconnectors

T8D 2000 – Fixed (F) – I_u (40 °C) = 2000 A - Front terminals (F)

		1SDA R1	
		3 Poles	4 Poles
	I_{cw}	40 kA	40 kA
		065752	065753

T8D 2500 – Fixed (F) – I_u (40 °C) = 2500 A - Front terminals (F)

		1SDA R1	
		3 Poles	4 Poles
	I_{cw}	40 kA	40 kA
		065754	065755

T8D 3200 – Fixed (VR) – I_u (40 °C) = 3200 A - Rear vertical terminals (VR)

		1SDA R1	
		3 Poles	4 Poles
	I_{cw}	40 kA	40 kA
		065756	065757

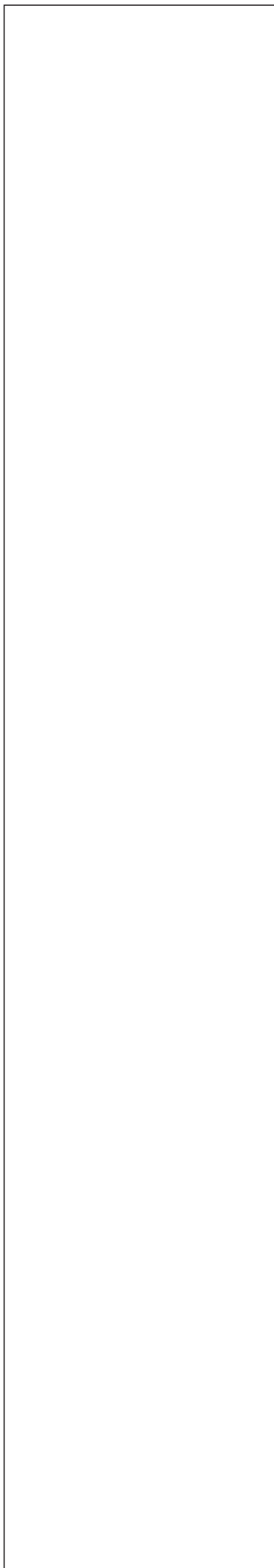

Ordering codes

Loose trip units

Electronic trip unit	1SDA.....R1	
PR232/P-T8-LSI	065828	
PR331/P-LSIG	065829	
PR332/P-LI	065830	
PR332/P-LSI	065831	
PR332/P-LSIG	065832	
PR332/P-LSIRc 3p ⁽¹⁾	065833	

Note: The loose trip units for T8 are supplied without rating plug.

⁽¹⁾ Not available for T8 3200 A and for 4p versions

Ordering codes

Accessories



1SDC200131F0001

Service releases

Shunt opening release (YO)

	1SDA.....R1
24 V DC	038286
30 V AC / DC	038287
48 V AC / DC	038288
60 V AC / DC	038289
110...120 V AC / DC	038290
120...127 V AC / DC	038291
220...240 V AC / DC	038292
240...250 V AC / DC	038293
380...400 V AC	038294
440 V AC	038295

Supplementary shunt opening release (YO2)

	1SDA.....R1
24 V DC	050157
30 V AC / DC	050158
48 V AC / DC	050159
60 V AC / DC	050160
110...120 V AC / DC	050161
120...127 V AC / DC	050162
220...240 V AC / DC	050163
240...250 V AC / DC	050164
380...400 V AC	050165
440 V AC	050166

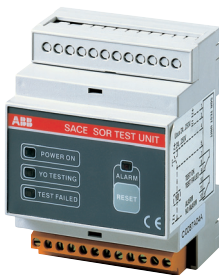

1SDC200135F0001

SOR Test Unit

	1SDA.....R1
T8	050228



1SDC200132F0001

Shunt closing release (YC)

	1SDA.....R1
24 V DC	038296
30 V AC / DC	038297
48 V AC / DC	038298
60 V AC / DC	038299
110...120 V AC / DC	038300
120...127 V AC / DC	038301
220...240 V AC / DC	038302
240...250 V AC / DC	038303
380...400 V AC	038304
440 V AC	038305

Ordering codes

Accessories

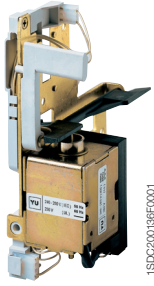

1SDC200138F0001

Undervoltage release (YU)

	1SDA.....R1
24 V DC	038306
30 V AC / DC	038307
48 V AC / DC	038308
60 V AC / DC	038309
110...120 V AC / DC	038310
120...127 V AC / DC	038311
220...240 V AC / DC	038312
240...250 V AC / DC	038313
380...400 V AC	038314
440 V AC	038315



1SDC200139F0001

Time delay device for undervoltage release (D)

	1SDA.....R1
24...30 V AC / DC	038316
48 V AC / DC	038317
60 V AC / DC	038318
110...127 V AC / DC	038319
220...250 V AC / DC	038320

Electric signals

Auxiliary contacts

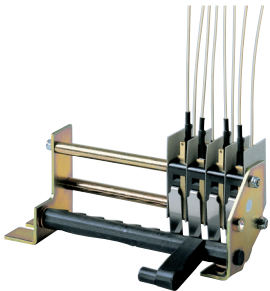

1SDC200145F0001

	1SDA.....R1
4 open/closed auxiliary contacts for PR232-T8-PR331	065971
4 open/closed auxiliary contacts for PR332 ⁽¹⁾	065819
4 open/closed auxiliary contacts V<24 V for PR232-T8-PR331	065972
4 open/closed auxiliary contacts V<24 V for PR332 ⁽¹⁾	065820
Contact signalling trip	058260
Contact signalling undervoltage release de-energised - NC	038341
Contact signalling undervoltage release de-energised - NO	038340

Note: Always supplied with automatic circuit-breakers

Trip reset

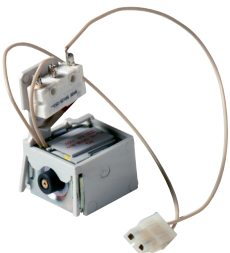

1SDC210N78F0001

	1SDA.....R1
Trip reset 24-30 V AC/DC	058263
Trip reset 110-130 V AC/DC	058262
Trip reset 200-240 V AC/DC	058261



1SDC210D2F0001



1SDC200198F0001



1SDC200198F0001



1SDC200157F0001



1SDC200168F0001

Mechanical signals

	1SDA.....R1
Mechanical operation counter	038345

Spring charging motor

	1SDA.....R1
Spring charging motor 24...30 V AC/DC	038321
Spring charging motor 48...60 V AC/DC	038322
Spring charging motor 100...130 V AC/DC	038323
Spring charging motor 220...250 V AC/DC	038324

Locks

	1SDA.....R1
Padlock	038351
Key lock - different keys	058271
Key lock - same keys (N. 20005)	058270
Key lock - same keys (N. 20006)	058274
Key lock - same keys (N. 20007)	058273
Key lock - same keys (N. 20008)	058272

Transparent protections

	1SDA.....R1
Transparent protection for pushbuttons	038343
Protection for door IP54	038344

Connections terminals

Rear flat orientated terminals

	1SDA.....R1
Kit HR/VR - 6 pieces	046578
Kit HR/VR - 8 pieces	046579

Note: Not available for T8 3200 A

Front extended spread terminals

	1SDA.....R1
Kit ES - 6 pieces	065824
Kit ES - 8 pieces	065825

Note: Not available for T8 3200 A; available as loose kit only

Ordering codes

Accessories



Separating partitions - PB

	1SDA.....R1
PB100 low (H=100 mm) - 2 pieces - 3p	066028
PB100 low (H=100 mm) - 3 pieces - 4p	066029
PB200 high (H=200 mm) - 2 pieces - 3p	066030
PB200 high (H=200 mm) - 3 pieces - 4p	066031

Note: For top terminals only

Accessories for protection trip units

Modules for protection trip units PR331-PR332

	1SDA.....R1
Voltage measurement module PR330/V 3p	065834 ⁽¹⁾
Voltage measurement module PR330/V 4p	065973 ⁽¹⁾
Communication module PR330/D-M (Modbus RTU)	063145
Actuation module PR330/R	065821
External wireless communication module BT030	058259
Power supply unit PR030B	058258

⁽¹⁾ **Note:** Ask ABB for availability

Current sensor for external neutral

	1SDA.....R1
Current sensor for external neutral 1000 A...3000 A	065845

Rating plug

	1SDA.....R1
In = 1000 A	063150
In = 1250 A	063151
In = 1600 A	063152
In = 2000 A	065835
In = 2500 A	065836
In = 3200 A	065838
In = 1000 A for Rc protection ⁽¹⁾	063728
In = 1250 A for Rc protection ⁽¹⁾	063731
In = 1600 A for Rc protection ⁽¹⁾	063732
In = 2000 A for Rc protection ⁽¹⁾	065839
In = 2500 A for Rc protection ⁽¹⁾	065840

⁽¹⁾ For PR332/P LSI Rc and Rc toroid

Extra code rating plug

	1SDA.....R1
In = 1000 A	063156
In = 1250 A	063157
In = 1600 A	065841
In = 2000 A	065842
In = 2500 A	065843
In = 1000 A for Rc protection ⁽¹⁾	063736
In = 1250 A for Rc protection ⁽¹⁾	063737
In = 1600 A for Rc protection ⁽¹⁾	064288
In = 2000 A for Rc protection ⁽¹⁾	065844

Note: To be specified in addition to the code of the automatic circuit-breaker.

⁽¹⁾ For PR332/P LSI Rc and Rc toroid

Homopolar toroid for residual current protection

	1SDA.....R1
Toroid RC ⁽¹⁾	064553

⁽¹⁾ For T8 3p only; not available for T8 3200 A

Homopolar sensor for the earthing conductor of the main power supply

	1SDA.....R1
Sensor	059145

External units for protection trip units

	1SDA.....R1
PR010/T - Test and configuration unit	048964
PR021/K - Signalling unit	059146
HMI030 - Switchgear interface	063143

Spare parts

Flanges for compartment door

	1SDA.....R1
Flange for compartment door	065855

Notes

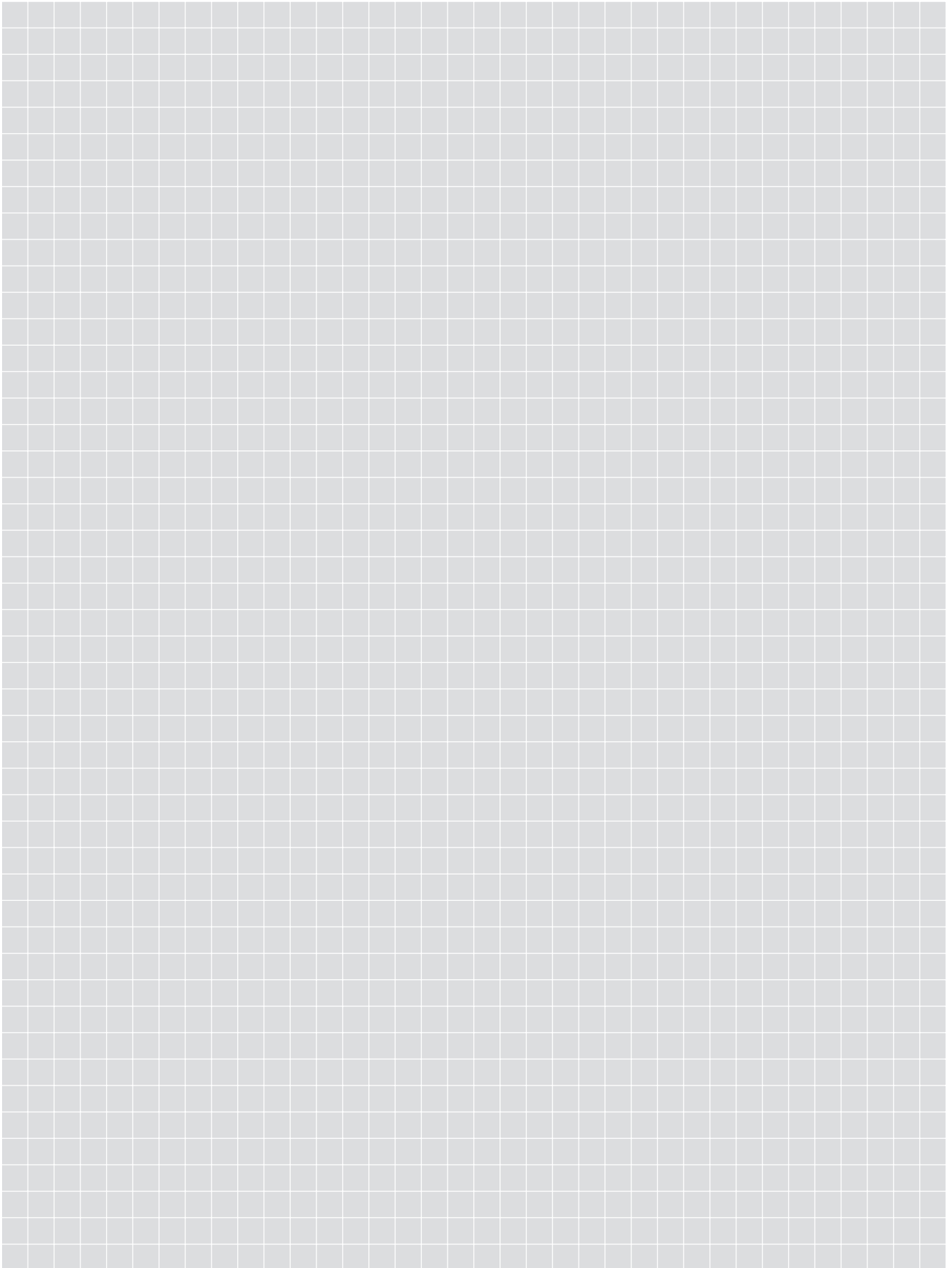

Notes

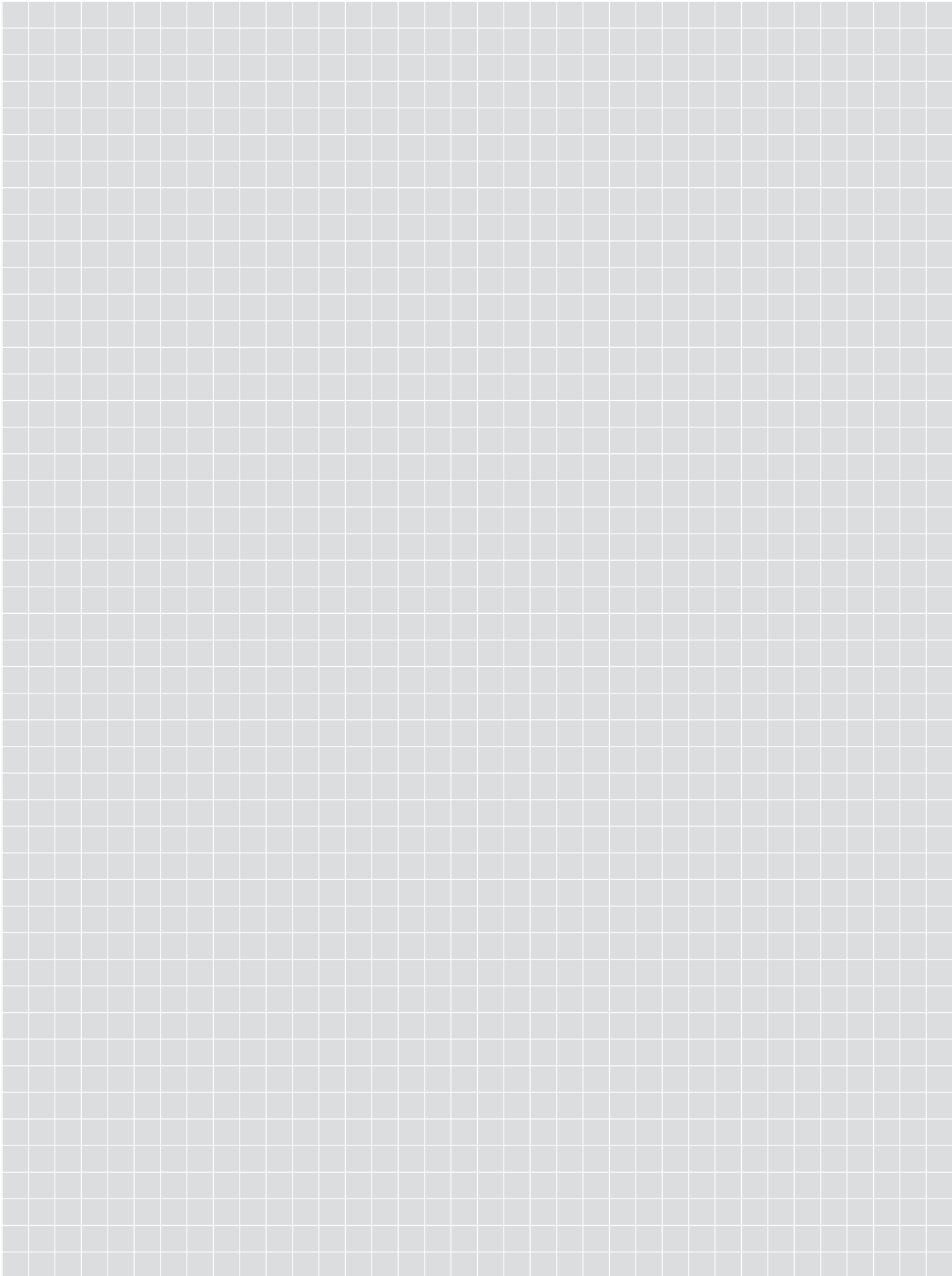

Notes





ABB SACE

A division of ABB S.p.A.

L.V. Breakers

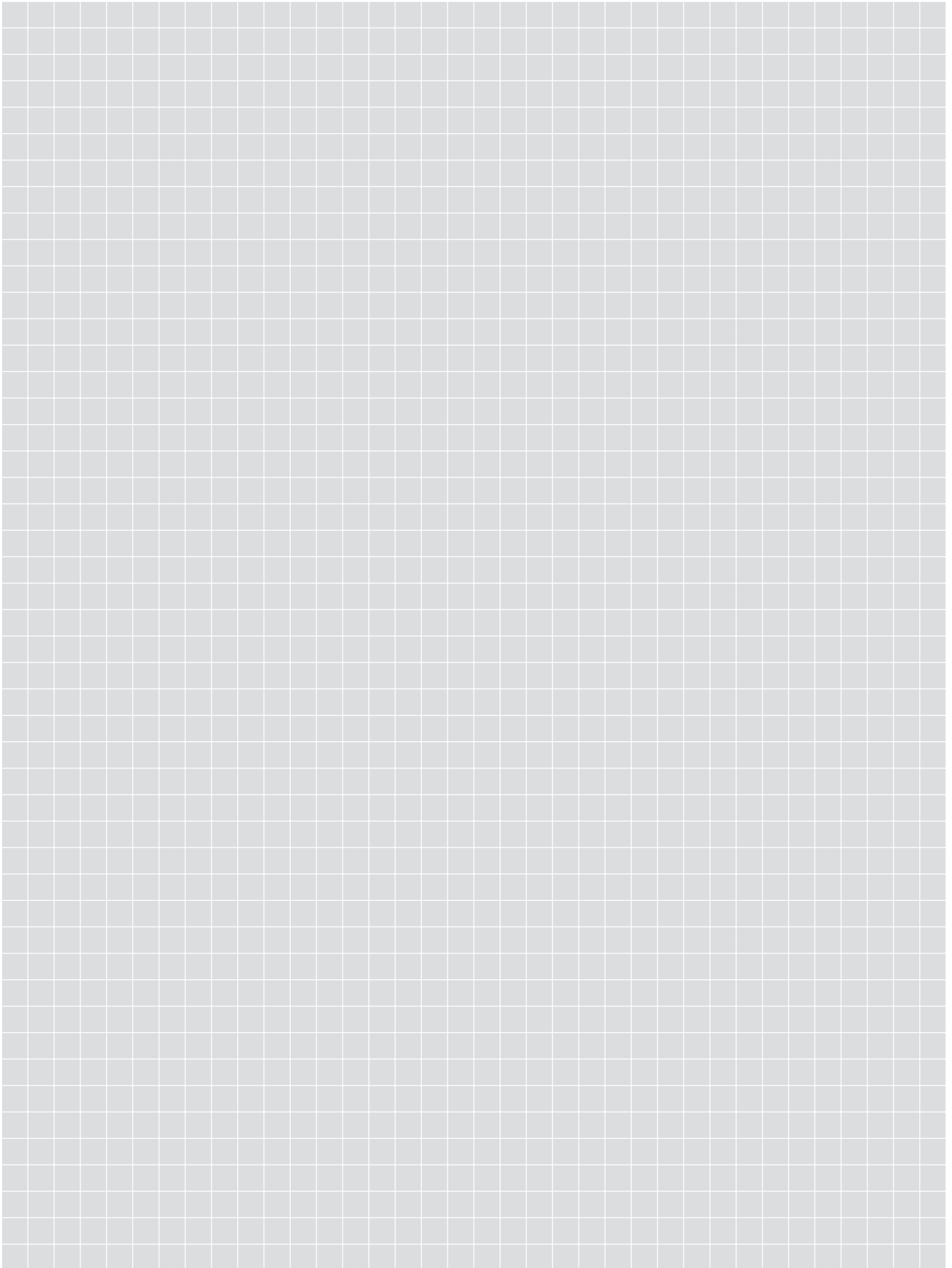
Via Baioni, 35

24123 Bergamo, Italy

Tel.: +39 035.395.111 - Telefax: +39 035.395.306-433

<http://www.abb.com>

Due to possible developments of standards as well as of materials, the characteristics and dimensions specified in the present catalogue may only be considered binding after confirmation by ABB SACE.