



Features:

- Universal Input 180 – 240 VAC
- AC Input Range Auto-Selectable
- Power Factor Corrected to EN61000-3-2 Class D
- Optional N+1 Active Current Sharing
- 12 VDC – 56 VDC Output
- Over-Current Protection
- Over-Voltage Protection
- 3 Mechanical Options
- RoHS Compliant



Input Voltage: 180-264 VAC, 47~63Hz.

Inrush Current: 70A Max @ 230VAC with full load cold start.

PFC: Active Power Factor Correction meets EN61000-3-2 class D.

Transient Response: Returns to within 1% in less than 2.5mS for a 50% load change and the peak transient does not exceed 5%.

Overshoot: Turn-on & off overshoot < 5% over nominal voltage.

Efficiency: 70% for 3.3V, 75% for 5V, 80% for 12V and 83% minimum for others output @ 230V and full load.

Turn On Delay: 1 second maximum at 120 VAC.

Hold Up Time: 20mS min. at 80% of full load.

Adjustability: Output user adjustable +/-5% minimum.

Remote On-Off: Designated as **RSW** on CN3, requires a low signal to inhibit output.

Remote Sense: Designated as **RS+** and **RS-** on CN3, voltage compensates for up to 0.5V line drop (not for current share model).

LED display: Bi-color **LED1** emit Green for Power On; And emit Orange when protection is enable or RSW is applied a low signal.

Power Good: Designated as **PG** on the CN3 and TTL high 100-500mS after regulation. It goes low at least 1mS before loss of regulation for Power on Reset signal.

Current Sharing: Designated as **CSH** on the CN3, optional single wired for forced current sharing function and parallel up to 4 units within 10% accuracy at full load.

Current Monitor: Designated as **CMN** on the CN3 is a 0.5V to 3VDC output voltage to represent 0% to 100% output current.

Input Fusing Protection: a T10A/250V fuse is inserted in primary.

Input Voltage Protection: Power shut down under 80 +/-5Vac, and recovered over 86Vac.

Short Circuit Protection: Trip without damage and auto-recovery.

Over-Power Protection: Fold back mode 110-140% and auto-recovery.

Over Voltage Protection: Unit latching down when output exceed 130% and recycle AC input to reset.

Over-Temperature Protection: Unit protected of excessive operating ambient 85°C, and automatic recovery.

Operating Temperature: 0 to 70°C ambient, de-rating at 2.5% per degree from 50°C to 70°C.

Storage Temperature: -20 to 85°C.

Operating Humidity: 5% to 90% RH, Non-condensing.

Storage Humidity: 5% to 95% RH, Non-condensing.

Vibration: 5 ~ 50 Hz, acceleration 7.35 m/s*s on X,Y and Z Axis.

Emissions: FCC Part 15, CISPR 22 class B, Conducted.

Safety Regulation: Approved to UL60950-1, CSA C22.2 No. 60950-1-03, TUV EN60950-1, CE Mark (LVD) EN61000-3-2,3 & IEC61000-4 Series Regulations and CB.

Leakage Current: 3.5mA max. @ 240Vac.

HI-POT Withstand Voltage: 1500 VAC input line to chassis (10mA DC cut off current); Isolating 3000VAC primary to secondary windings; Primary to core 1500VAC. All for 3 sec.

Grounding Test: Apply 25 A from ground pin of the three prong plug to the far most earth. Max allowable resistance 0.1 ohm.

MTBF: 150,000 Hrs (according to MIL-HBK-217F) at 30°C.

Enclosure: Enclosed Type – 9.17(L) X 4.25(W) X 2.5(H) inches. U-Chassis Type – 8(L) x 4.33(W) x 2.5(H) inches.

Cooling: Enclosed Type – self cooled by built-in fan. U-Chassis Type – 30 CFM to achieve maximum power for all models.

Burn in: 45°C ±5°C for 1 hour @230Vac with full load.

Weight: Enclosed Type: 1450g; U-Chassis Type: 1350g.



SDY800T1 Series

Single Output, Switchmode Power Supply
Active PFC, RoHS Compliant

Date: 9/14/09

Rev: 090909

Page: 2 of 5

Output Voltage and Current Chart

Model Number**	Preset Voltage	Available Voltages	Max. Output Current	Max. Output Power	Efficiency	Ripple & Noise
SDY800T1XXR	12 VDC	12 - 15 VDC	62.5 A	750 Watts	80%	±1%
SDY800T1XXR	18 VDC	16 - 21 VDC	50 A	800 Watts	83%	±1%
SDY800T1XXR	24 VDC	22 - 30 VDC	36.36 A	800 Watts	83%	±1%
SDY800T1XXR	36 VDC	31 - 47 VDC	25.8 A	800 Watts	83%	±1%
SDY800T1XXR	48 VDC	48 - 56 VDC	16.66 A	800 Watts	83%	±1%

** To Determine Part Number:

- Replace "XX" with Desired Output Voltage (12VDC = "12", 48VDC = "48", etc.)
 - Replace "Y" with Desired Case Code:
 - Type **U**: U-Chassis
 - Type **C**: U-Chassis with Cover
 - Type **E**: Enclosed with Top Built-In Fan
 - Conformal Coating (Optional): Order as SDY800T1XX**CR**
 - Current Sharing N+1 Redundancy (Optional): Order as SDY800T1XX**RN**
 - Input Connector: For Enclosure w. Fan (SD**E**800T1XXR): IEC320-C14 Inlet or 3-Position Barrier Strip.
For U-Channel (SD**U**800T1XXR) & Cover (SD**C**800T1XXR): Crimp Style PCB Header (7-Pin, 5 Used) or 3-Position Barrier Strip.
 - Output Connector: 20-Pin Crimp Style PCB Header or 8-Position Barrier Strip.
For Crimp Style PCB Header (or IEC320-C14 Input), Order as: SDY800T1XXR (Unchanged)
For Barrier Strip, Order as: SDY800T1XX**AR**
- Example: SD**E**800T1XXR indicates an Enclosed, Side Fan Case and Crimp Style PCB Header
SD**C**800T1XX**ACRN** indicates a U-Chassis Case with Case Cover, with Barrier Strip, Current Sharing, and Conformal Coating.



TECHNOLOGIES INC.
HICKSVILLE, NEW YORK

• 264 Duffy Avenue
Hicksville, NY 11801

• Tel: (516) 433-1313
• Fax: (516) 433-1457

• Web: www.apxonline.com
• Email: sales@apxonline.com

• © Copyright 1978
APX Technologies, Inc.



SDY800T1 Series

Single Output, Switchmode Power Supply
Active PFC, RoHS Compliant

Date: 9/14/09

Rev: 090909

Page: 3 of 5

Pin Connection: SDY800T1XXR

Pin	Input: Molex 7-Pin Terminal
1-2	Neutral
3	N/C
4-5	Line
6	N/C
7	Ground
Pin	Output: Molex 20-Pin Terminal
1-10	Output
11-20	Return

Pin Connection: SDY800T1XXAR

Pin	Output: 8-Position Barrier Strip
1-4	Output
5-8	Return

NOTES:

AC Input Connector (CN1): Enclosed Type: IEC320 or equivalent Snap-in mounting type or DINKLE Terminal block Part No. DT-35-A02W-03 (3 pin). U-Chassis Type: Mating Molex Part No. 09-91-0700 or equivalent (7 pin. 5 used) or Howder Terminal block Part No. HD-121-3P.

Output Connector (CN2): Mating Molex Part No. 09-91-2000 (20 pin) or Howder Terminal block Part No. HD-121-8P (8 pin).

Logic signal connectors (CN3): Mating JST XHP-7 or equivalent (CHYAO SHIUNN JS-001-07).

Fan Drive: 12VDC/500mA Mating JST XHP-2 or equivalent (CHYAO SHIUNN JS-2001-02).

Mounting Inserts: 6-32, M4 4 Places individually with maximum penetration 0.2 inch on bottom side and 0.25 inch on both side.



TECHNOLOGIES INC.
HICKSVILLE, NEW YORK

264 Duffy Avenue
Hicksville, NY 11801

Tel: (516) 433-1313
Fax: (516) 433-1457

Web: www.apxonline.com
Email: sales@apxonline.com

© Copyright 1978
APX Technologies, Inc.



SDY800T1 Series

Single Output, Switchmode Power Supply
Active PFC, RoHS Compliant

Date: 9/14/09

Rev: 090909

Page: 4 of 5

Type **U**: U-Chassis Case
Order as: SD**U**800T1XXR

Type **C**: U-Chassis Case w/ Cover
Order as: SD**C**800T1XXR

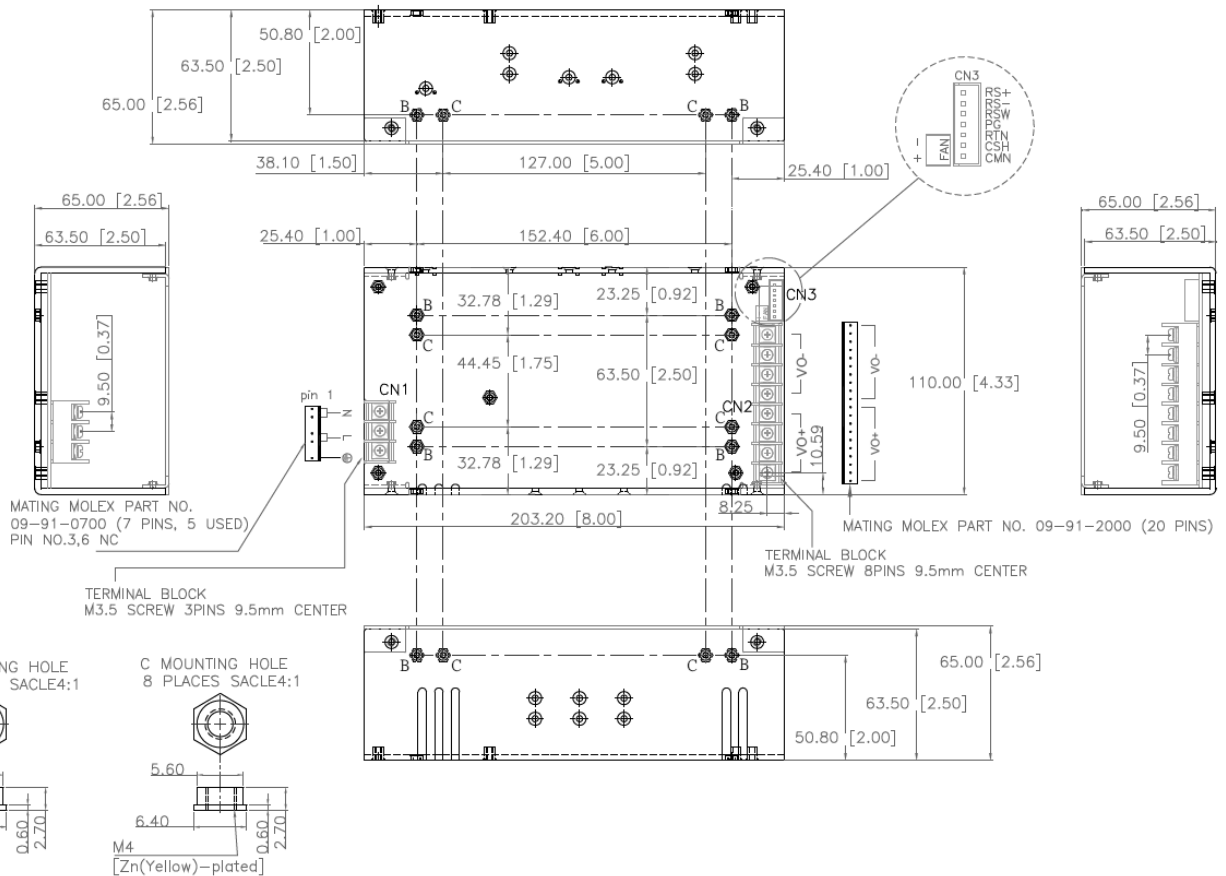
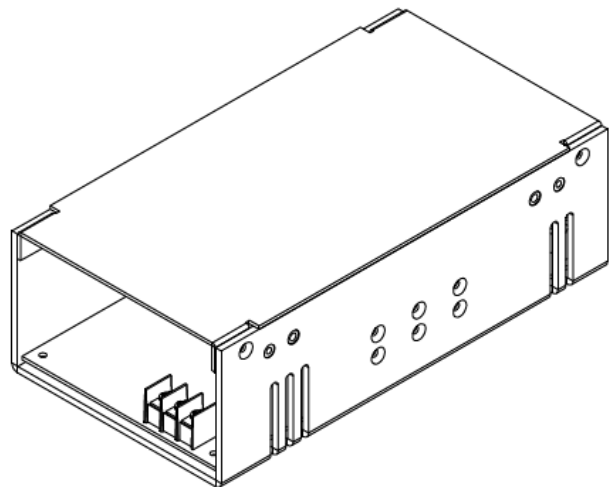
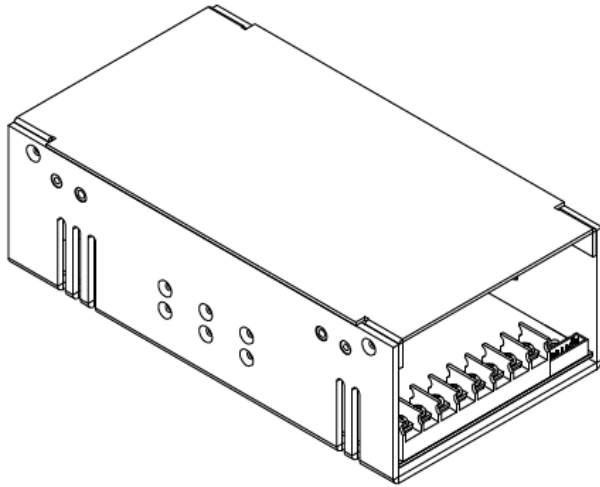

Type **E**: Enclosed Case w/ Side Fan
Order as: SDE800T1XXR

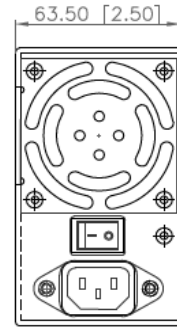
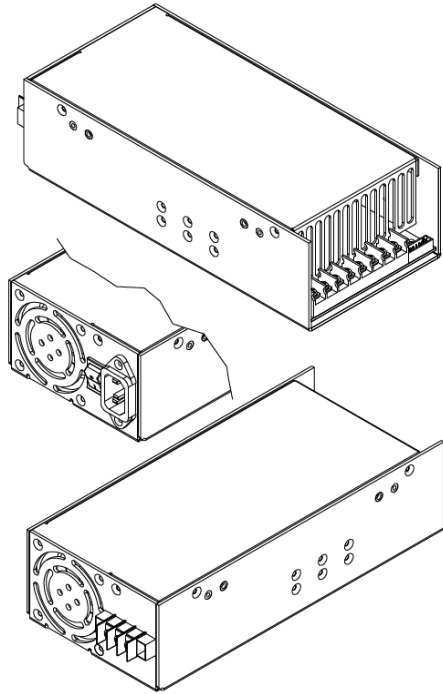

IEC320 or EQU.

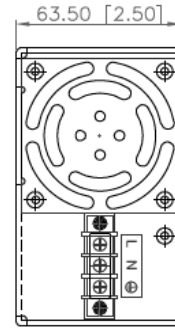

TERMINAL BLOCK
M3 SCREW
3PINS 8.25mm CENTER

C MOUNTING HOLE 8 PLACE
SACLE4:1

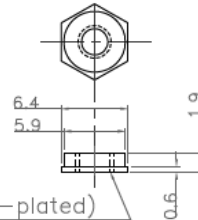

B MOUNTING HOLE 8 PLACE
SACLE4:1

