

SPECIFICATIONS

Electrical Ratings	50mA @ 48VDC
Electrical Life	100,000 cycles typical
Contact Resistance	< 50 mΩ initial
Actuation Force	100, 130, 160, 260 +/- 50gF
Actuator Travel	.25 +/- .1mm
Dielectric Strength	1000Vrms min
Insulation Resistance	> 100MΩ min
Operating Temperature	-40°C to 85°C
Storage Temperature	-40°C to 85°C
Standard Packaging	1000pcs (ammo pack)



MATERIALS ←RoHS COMPLIANT

Actuator	6/6 Nylon
Housing	6/6 Nylon
Cover	Polyester
Contacts	Phosphor Bronze, Silver Plated
Terminals	Brass, Silver Plated

ORDERING INFORMATION

1. Series:	CR1102H	7.0	F160
CR1102H			
2. Actuator Length "L" (mm):			
4.3			
5.0			
7.0			
7.3			
9.5			
3. Actuation Force:			
F100 = 100gF			
F160 = 160gF			
F260 = 260gF			

DIMENSIONS

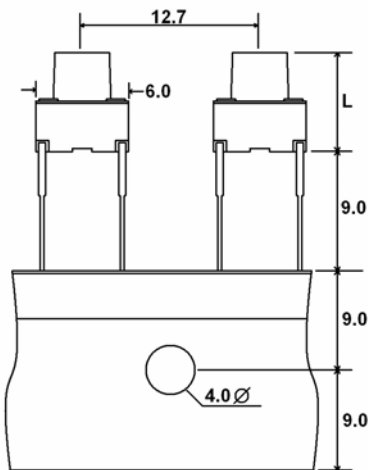

SCHEMATIC & PC LAYOUT

