



Specifications

Electrical Ratings	
2 position switch	20A @ 120VAC 16A @ 250VAC General Purpose 1hp @ 250VAC; 3/4 hp @ 125VAC
3 position switch	15A @ 125VAC 10A @ 250VAC General Purpose

Switch Function	SPST Illuminated, DPST, DPDT
Electrical Life	10,000 cycles typical
Contact Resistance	≤ 50mΩ initial
Dielectric Strength	1500Vrms min
Insulation Resistance	≥ 100MΩ min
Operating Temperature	-30°C to +80°C
Storage Temperature	-30°C to +80°C

Materials

Housing	6/6 Nylon
Actuator	6/6 Nylon, PC Illuminated
Contacts	Silver Alloy
Terminals	Brass, Silver Plated
Lamp	Neon or Tungsten

Ordering Information

1. Series	RW	1	1	2	5T	D	W	C	T12
RW									
2. Number of Poles	1 = Single Pole **Illuminated only 2 = Double Pole **Not available illuminated								
3. Switch Function () = momentary	1 = OFF - NONE - ON **Illumination only available with this function 2 = OFF - NONE - (ON) 3 = (OFF) - NONE - ON 4 = ON - NONE - ON 5 = ON - NONE - (ON) 6 = ON - OFF - ON 7 = (ON) - OFF - (ON) 8 = ON - OFF - (ON)								
4. Housing Color	1 = White 2 = Black 9 = Gray								
5. Actuator Colors	1 = White 4 = Yellow 7 = Blue 1T = White Transparent 5T = Green Transparent 2 = Black 5 = Green 8 = Purple 3T = Red Transparent 7T = Glue Transparent 3 = Red 6 = Orange 9 = Gray 4T = Yellow Transparent								
6. Actuator Marking	A D G J B E H K C F I								
7. Actuator Marking Color	A = No Marking W = White B = Black R = Red								
8. Terminal Options	C = .187" Quick Connects / Solder Lug								
9. Lamp Options	N1 = 125VAC Neon Lamp T12 = 12VDC Tungsten Lamp N2 = 250VAC Neon Lamp T24 = 24VDC Tungsten Lamp								

Illuminated Rocker

Dimensions

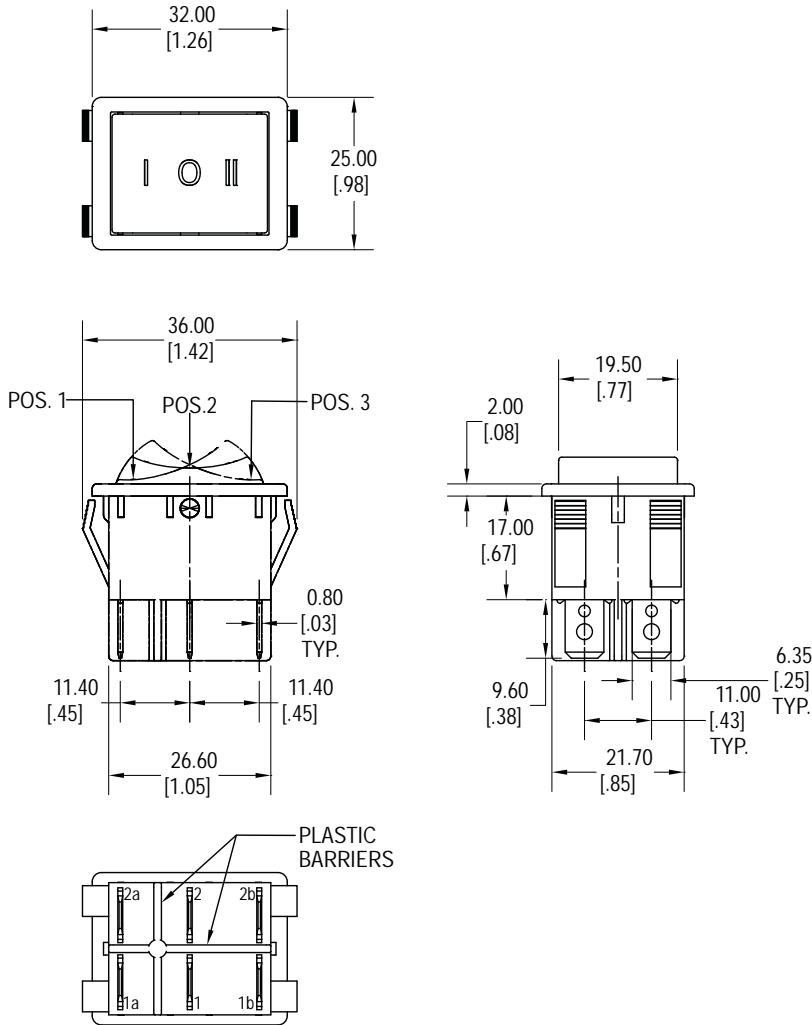

Switch Function			
Function	Position 1	Position 2	Position 3
1*	OFF	NONE	ON
2	OFF	NONE	(ON)
3	(OFF)	NONE	ON
Terminals	--	--	1 ~ 1a 2 ~ 2a
4	ON	NONE	ON
5	ON	NONE	(ON)
6	ON	OFF	ON
7	(ON)	OFF	(ON)
8	ON	OFF	(ON)
Terminals	1 ~ 1b 2 ~ 2b	--	1 ~ 1a 2 ~ 2a

* Illuminated function only
() = Momentary function

Schematics

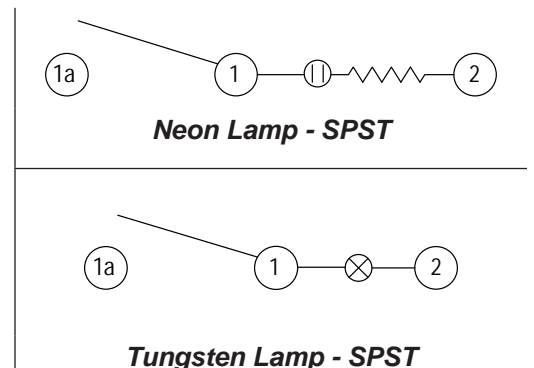
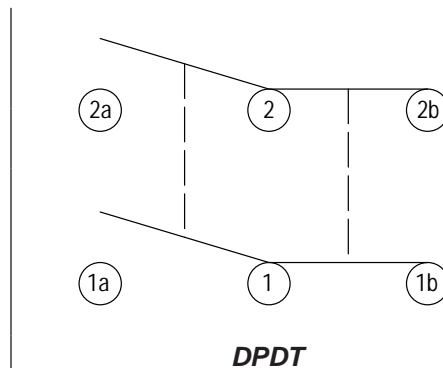
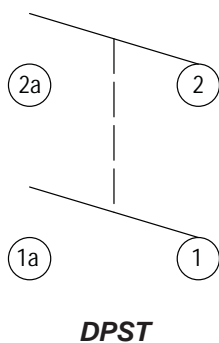

Actuator Marking Options

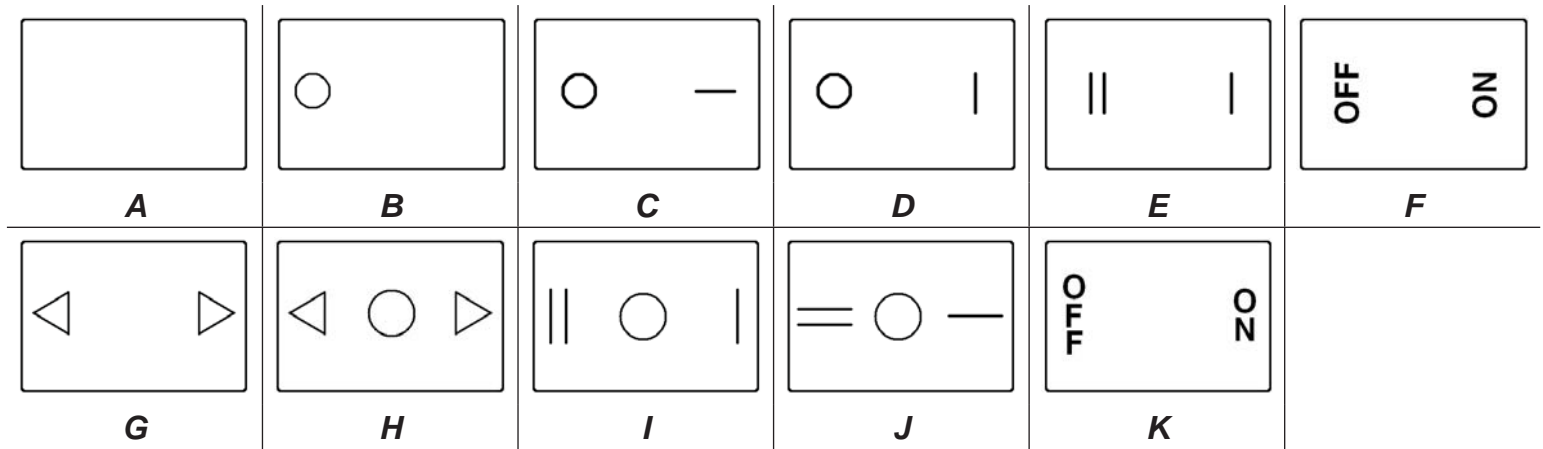

Panel Cut Out

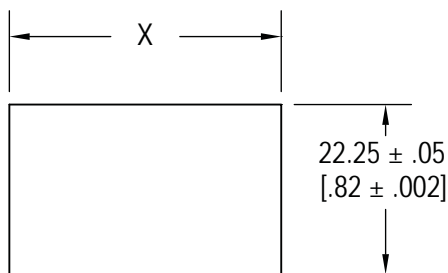

Panel Thickness	X
0.75 ~ 1.25	30.0 ~ 30.2
1.25 ~ 2.00	30.2 ~ 30.4
2.00 ~ 3.00	30.6 ~ 30.8

Panel cut out material thickness : 0.7mm ~ 3.0mm

Terminal Options

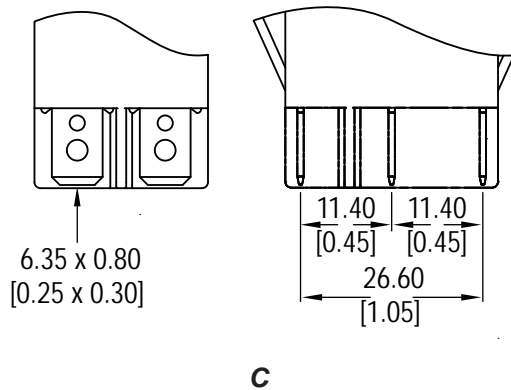

Sealing Boot

