

# MARINE

Switches, Circuit Protection & ELCI/GFCIs



CATALOG

# FOUNDED IN 1920

Since its founding, Carling Technologies has continually forged a tradition of leadership in quality and product innovation.

There are few products that Carling Technologies hasn't turned "ON" and fewer industries that haven't turned to Carling for solutions. With ISO and TS registered manufacturing facilities and technical sales offices worldwide, Carling ranks among the world's largest manufacturers of circuit breakers, switches, power distribution units, digital switching systems and electronic controls.



## SWITCHES & CONTROLS

- Rocker
- Toggle
- Pushbutton
- Rotary

## CIRCUIT PROTECTION

- Hydraulic-Magnetic
- Thermal
- GFCI / ELCI

## CUSTOM SOLUTIONS

- PDU's
- Keypads
- Control Modules

## MULTIPLEXED POWER SYSTEMS

- HMI Devices & I/O Modules
- Programmable Displays
- Data Communication Interfaces
- Electrical Systems Monitoring

## STRATEGIC MARKETS SERVED:



On/Off Highway



Marine



Telecom/Datacom



Military



Renewable Energy

## GLOBAL LOCATIONS:

Carling Technologies  
World Headquarters  
Plainville, CT, USA  
ISO 9001:2008  
ISO/TS16949:2009

Maretron  
Phoenix, AZ, USA

Carling Technologies  
Brownsville, TX, USA  
ISO 14001:2004  
ISO 9001:2008  
ISO/TS16949:2009

Carling Technologies  
Matehuala, Mexico  
ISO 14001:2004  
ISO 9001:2008  
ISO/TS16949:2009

Carling Technologies  
Jupiter, FL, USA

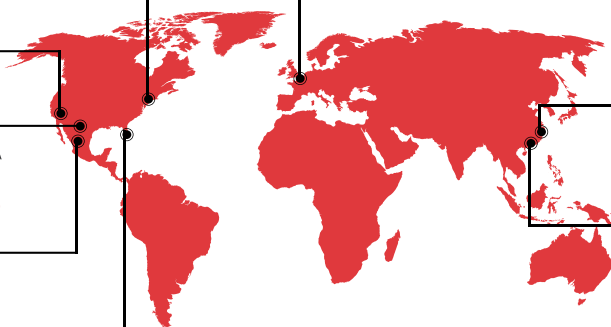

Carling Technologies  
European Headquarters  
Exeter, UK  
ISO 9001:2008  
ISO/TS16949:2009

Carling Technologies  
Kowloon, Hong Kong  
ISO 9001:2008  
ISO/TS16949:2009

Carling Technologies  
Zhongshan, China  
ISO 14001:2004  
ISO 9001:2008  
ISO/TS16949:2009

## OTHER SERVED INDUSTRIES:



Medical



Industrial Control



Audio / Visual



Commercial Food



HVAC



Floor Care



Generators



Small Appliances



Security Systems



Test & Measurement

## WORLDWIDE NUMBERS:



2200+  
EMPLOYEES



150+  
ENGINEERS

## COMPETITIVE ADVANTAGES<sup>+</sup>

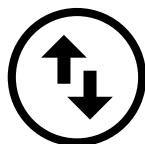

Vertical  
Integration



Reliable &  
On-Time Delivery



Excellent  
Customer Service



Innovative &  
Eco-Friendly Products



70+  
DISTRIBUTORS



50+  
REP FIRMS

# Marine

## Switches, Circuit Breakers & ELCI/GFCIs

With years of design and manufacturing experience, Carling Technologies is the market leader in marine application switches, circuit breakers and ELCIs. From small boats to luxury yachts, OEM design engineers trust our products not only for their style but also for their performance. Carling's switches are widely used and the most recognizable switch brand in the industry with unmatched quality and aesthetics. Its circuit breakers and ELCIs are guaranteed to perform under extreme marine environments while keeping boats and boaters safe from electrical currents. By drawing upon over 90 years of design experience, Carling Technologies is also able to provide custom product solutions that are sure to meet the most stringent design requirements.

**Within This Catalog**, you will find comprehensive product information for each product series including applications, specifications and ordering schemes.

**Available Online** are tools such as part configurator, product selectors and stock checks. Please visit [www.carlingtech.com](http://www.carlingtech.com) for the latest information on all our products.

**Application Solution Engineers** are readily available to assist you in selecting the appropriate product for your application. For further assistance, please email us at [custservice@carlingtech.com](mailto:custservice@carlingtech.com)

**Custom Design Solutions** are available for OEMs that require specific product design and performance.





### Other Circuit Protection Products

such as thermal protection and ground fault circuit protection are also available. Please refer to [www.carlingtech.com](http://www.carlingtech.com) for a complete list of product offering.

## Table of Contents





	page
Product Selector Guide.....	2
<b>Switches &amp; Controls</b>	
V-Series - Sealed Switch .....	5
V-Series - Rotary Switch.....	24
V-Charger - Sealed Control .....	31
W-Series - Submersible Switch.....	38
Standard Legend Imprinting.....	177
LT-Series - Toggle Switch .....	43
F-Series - Toggle Switch.....	45
G-Series - Toggle Switch .....	47
P27-Series - Pushbutton Switch .....	49
<b>Circuit Breakers</b>	
M-Series .....	51
A-Series .....	68
B-Series .....	94
C-Series .....	111
E-Series .....	132
Time Delay Values .....	141
<b>Thermal</b>	
CMB-Series.....	147
CLB-Series .....	149
CMBA/CLBA-Series .....	151
<b>ELCIs/GFCIs</b>	
PB-Series.....	153
PC-Series .....	162

ROCKERS				
	 V-Series	 V-Series Rotary	 V-Charger	 W-Series
<b>Poles</b>	1, 2	1, 2	1	1, 2
<b>Ratings</b>	up to 15A 24VDC 15A 125VAC 10A 250VAC	up to 15A 24VDC 20A 12VDC	12V/24V DC	up to 10A 24VDC
<b>Actuator</b>	rocker, paddle, locking rocker	ergonomic knob	sealed spring-loaded access doors	bezel-less rocker, paddle & locking rocker
<b>Mounting Hole Specifications</b>	.830" x 1.450" [21.08mm x 36.83mm] snap-in mount	.830" x 1.450" [21.08mm x 36.83mm] snap-in mount	.830" x 1.450" [21.08mm x 36.83mm] snap-in mount	.830" x 1.450" [21.08mm x 36.83mm] snap-in mount
<b>Termination</b>	.250 tabs solder lug wire leads	solder lugs .250 tabs wire leads	.250 tabs	.110 tabs
<b>Sealing</b>	IP66 above panel	IP67 above panel	IP64 above panel	IP68 above and below panel, fully submersible
<b>Illumination</b>	incandescent, LED, neon	incandescent, LED	LED	LED
<b>Approvals</b>	UL, CSA, VDE	pending	n/a	n/a





TOGGLES				PUSHBUTTON
	 LT-Series	 F-Series	 G-Series	 P27-Series
<b>Poles</b>	1, 2	1	1, 2	1
<b>Ratings</b>	up to 15A 125VAC 10A 250VAC 15A 12-28VDC	up to 20A 125VAC 20A 277VAC 2 HP 250VAC	up to 20A 125VAC 20A 277VAC 2 HP 250VAC	up to 6A 125VAC 3A 277VAC
<b>Actuator</b>	paddle, toggle (bat)	paddle, toggle (bat)	paddle, toggle (bat)	nylon concave pushbutton
<b>Mounting Hole Specifications</b>	.500" dia [12.7mm] bushing mount	.500" dia [12.7mm] bushing mount	.500" dia [12.7mm] bushing mount	.500" dia [12.7mm] bushing mount
<b>Termination</b>	.187 tabs solder lug .250 tabs screw terms wire leads PC terms	.187 tabs solder lug .250 tabs screw terms wire leads PC terms	.187 tabs solder lug .250 tabs screw terms wire leads PC terms	.250 tabs solder lug wire leads
<b>Sealing</b>	standard bushing o-ring	optional bushing o-ring	optional bushing o-ring	n/a
<b>Illumination</b>	incandescent, neon	n/a	n/a	n/a
<b>Approvals</b>	n/a	UL, CSA, VDE	UL, CSA, VDE	UL CSA

\*Options and approvals shown may apply to specific construction combinations only, consult factory for clarification.  
 Manufacturer reserves the right to change product specifications without prior notice.

HYDRAULIC-MAGNETIC CIRCUIT PROTECTION

	 <i>M-Series</i>	 <i>A-Series</i>	 <i>B-Series</i>	 <i>C-Series</i>	 <i>E-Series</i>
<b>Number of Poles</b>	1-2	1-6 (handle) 1-3 (rocker & metal toggle)	1-6	1-6 (handle) 1-3 (rocker & metal toggle)	1-6
<b>Actuator Style</b>	solid color: angled rocker, paddle, baton, push-to-reset pushbutton, push-pull pushbutton two color: visi-rocker illuminated: angled rocker, flat rocker	sealed metal toggle handle rocker paddle	handle rocker	sealed metal toggle handle rocker	handle
<b>Available Delays</b>	AC/DC: instantaneous, short, medium, hi-inrush	AC, DC, AC/DC: instantaneous, ultra-short, short, medium & long AC, DC: high inrush-short, medium & long	AC, DC, AC/DC: instantaneous, ultra-short, short, medium & long AC, DC: high inrush-short, medium & long	AC, DC, AC/DC: instant, ultrashort, short, medium & long AC, DC: high inrush-short, medium & long	AC, DC, AC/DC: instant, short, medium & long AC, DC, AC/DC: high inrush-short, medium & long
<b>Max Current &amp; Voltage Ratings</b>	<b>1 Pole:</b> 0.02-15FLA@ 32VDC,125VAC 15.1-25GPA@32VDC,125VAC 0.02-12FLA@250VAC 0.02-7.5GPA@50VDC 0.02-30GPA@65VDC, 80VDC <b>2 Pole:</b> 0.02-15FLA@65VDC, 250VAC 15.1-25GPA@65VDC, 250VAC <b>Parallel Pole:</b> 31-50GPA@80VDC	0.02-30A@277VAC, 80VDC 31.0-50A@125/250VAC, 65VDC	0.02-30A@277VAC, 80VDC 02-30A@125/250VAC, 65VDC	<b>UL Listed:</b> 0.02-250A@80VDC 0.1-100A@125VDC 0.02-70A@120VAC 0.02-20A@240VAC <b>UL Recognized:</b> 0.02-30A@480WYE/277VAC 2 Pole, 1Ø; 3 Pole, 3Ø 0.02-50A@277VAC 0.02-100A@250VAC, 80VDC 0.02-100A@120V/ 240VAC, 65VDC	<b>UL Listed</b> 0.02-100A@240VAC, 80VDC, 125VDC  <b>UL Recognized</b> 0.02-100A@277VAC, 160VDC, 1 pole 0.02-100A@600VAC, 2 Pole 1Ø, 3 pole 3Ø 0.02-120A@125VDC, 1 pole
<b>Max Interrupting Capacity</b>	<b>1 Pole:</b> 1,000A@32VDC 1,000A@125VAC <b>2 Pole:</b> 1,000A@65VDC 1,000A@250VAC <b>Parallel Pole:</b> 600A@80VDC	7500A@80VDC, UL only 3000A@120/250VAC, UL only 5000A@277VAC, with fuse backup	7500A@80 VDC, UL only 3000A@125/250VAC, UL only 5000A@277VAC, with fuse backup	<b>UL Listed:</b> 50000A@80VDC, 1P only 10000A@120VAC 5000A@125VDC/240VAC <b>UL Recognized:</b> 7500A@80VDC 3000A@125/250VAC, UL only 5000A@250VAC listed construction 5000A@480WYE/277VAC with fuse backup	<b>UL Listed</b> 50000A@80VDC 10000A@125VDC & 240VAC-5KA  <b>UL Recognized</b> 5000A@125VDC 5000A@600VAC, without fuse backup 10000A@600VAC, with fuse backup
<b>Auxiliary Switch Rating</b>	7A@250VAC 0.1A@125VAC (gold contacts) 7A (res.)@28VDC 4A (ind.)@28VDC 0.25A@80VDC	10.1A@125VAC 0.1A@125VAC (gold contacts) 0.5A@65VDC 0.1A@80VDC	10.1A@125VAC 0.1A@125VAC (gold contacts) 0.5A@65VDC 0.1A@80VDC	10.1A@250VAC 0.1A@125VAC (gold contacts) 0.5A@80VDC	10.1A@250VAC 1.0A@65VDC 0.1A@80VDC
<b>Available Circuits</b>	series and switch only parallel pole	series, shunt, relay, switch only, series with remote shutdown, relay & shunt trip dual coil	series, shunt, relay, switch only, series with remote shutdown, relay & shunt trip dual coil, mid-trip with alarm switch	series, shunt, relay, switch only, series with remote shutdown, relay & shunt trip dual coil, mid-trip with alarm switch	series, shunt,relay, switch only, series with remote shutdown
<b>Terminal Options</b>	.250" QC tabs, 8-32 screw with upturned lugs, 8-32, 10-32 screw (bus type), push in stud terminals	.250" QC tabs 8-32 & 10-32 screw (& metric), PCB	.250" QC tabs, 8-32 & 10-32 screw (& metric), PCB	10-32 stud, 1/4-20 stud, 10-32 screw with saddle clamp, 7/16 clip & push-In	10-32 stud, 1/4-20 stud, 0-32 screw, 1/4-20 screw, box wire connector
<b>Mounting Method</b>	snap-in front panel threaded bushing	threaded inserts: front panel snap-in	threaded inserts: front panel snap-in	threaded inserts	rear or front panel
<b>Agency Approvals</b>	UL recognized, CSA, VDE, TUV, UL489A listed	UL, CSA, VDE, TUV (rocker), UL1500, UL489A	UL, CSA, VDE, TUV (rocker), UL1500, UL489, UL489A	UL, CSA, VDE, TUV, UL1500, UL489, UL489A	UL, CSA, VDE, UL1500, UL489

\*Options and approvals shown may apply to specific construction combinations only, consult factory for clarification.

	THERMAL CIRCUIT PROTECTION			GFCI / ELCI CIRCUIT PROTECTION	
	 CMB-Series	 CLB-Series	 CLBA/CMBA-Series	 PB-Series	 PC-Series
<b>Number of Poles</b>	1	1	1	1-3 poles, 3rd pole switched neutral	1-poles (1 circuit breaker + 1 GFCI sensor module), 120V, 2-pole (2 circuit breakers + 1 GFCI sensor module), 120/240V, or 120V with neutral break 2-pole (2 circuit breakers + 1 GFCI sensor module), 240VAC, 3-pole 120/240V with neutral break (sensor module has 2 pole width)
<b>Actuator</b>	pushbutton	pushbutton	n/a	handle, rocker, flat rocker actuators	handle, rocker, flat rocker, push-to-reset actuators
<b>Leakage Current Trip Level</b>	n/a	n/a	n/a	30mA & 6mA	30mA & 6mA
<b>Leakage Current Trip Time</b>	n/a	n/a	n/a	<b>For 30mA leakage trip:</b> ≤ 22.2mA, shall not trip 30mA, shall trip within .10 seconds, complying with UL-1053 & ABYC E11.  <b>For 6mA leakage trip:</b> ≤25ms	<b>For 30mA leakage trip:</b> ≤ 22.2mA, shall not trip 30mA, shall trip within .10 seconds, complying with UL-1053 & ABYC E11.  <b>For 6mA leakage trip:</b> ≤25ms
<b>Max Current &amp; Voltage Ratings</b>	3 to 20A, 125-250VAC, 32VDC	3 to 60A, 125-250VAC, 32VDC	3 to 40A, 125-250VAC, 32VDC	0.10-30A@120/240VAC	0.10-50A@120/240VAC - 240VAC
<b>Max Interrupting Capacity</b>	2500A@32 VDC	2500A@32 VDC	2500A@32 VDC	5,000A	5,000A
<b>Available Circuits</b>	series trip manual reset	series trip manual reset	series trip auto reset	series trip	series trip
<b>Termination</b>	.250 tab .250 tab with 90° bend screw terminal screw term with 90° bend	.250 tab .250 tab with 90° bend screw terminal screw term with 90° bend	.250" tab, .250" tab with 90° bend	.250 tab, 8-32, 10-32, M4,M5 screw with up-turned lugs 8-32, 10-32, M4, M5 screw, bus type	10-32 threaded stud
<b>Mounting Method</b>	threaded bushing, front panel snap-in	threaded bushing, front panel snap-in	plug-in	front panel	front panel
<b>Approvals</b>	UL, CUL, CSA, TUV, CE, UL 1500 / ISO 8846 for ignition protection / marine	UL, CUL, CSA, TUV, CE, UL 1500 / ISO 8846 for ignition protection / marine	UL, CUL, TUV, UL 1500 / ISO 8846 for ignition protection / marine	UL489, UL1077, UL1500	CSA Approved, UL 1053, UL 1500

\*Options and approvals shown may apply to specific construction combinations only, consult factory for clarification.

# V-Series

## V-Series

### CONTURA SWITCHES

Carling Technologies' sealed V-Series Contura switches are well known for their cutting edge design, high quality, maximum performance and unmatched reliability. These switches are a staple in the marine and transportation industries and have passed a range of environmental, corrosion, temperature, vibration, shock and sealing tests including MIL Std 202F, MIL Std 810C, UL 1500, ISO 8846, IEC 60529 and BS 5490 among others, making them one of the most rugged and reliable switches ever manufactured.



#### Resources:

[Download 3D CAD Files](#)



[Watch Product Video](#)



#### Product Highlights:

- ♦ Certified to IP66 with dual seals around lamps and rocker stem.
- ♦ Silver plated butt contact mechanism provides reliability up to and beyond 100K electrical cycles
- ♦ Greaseless construction withstands temperature extremes down to -40°C
- ♦ The switch accommodates up to 10 terminals and endless illumination and circuit options.
- ♦ The switch connector allows the user to preload FQC terminals for ease of assembly.
- ♦ Numerous choices of removable rockers allow for style change without having to retest or re-qualify the switch base.

# V-Series Switch

## DESIGN FEATURES

### INTERCHANGEABLE ACTUATORS

Panel redesign is a snap with our wide range of rocker styles. Achieve maximum design variety with minimum inventory. Simply swap rockers to create an entirely new look for your panel.

### DUAL SEAL PROTECTION

Seals out water, dust, debris, and enables switch certification to IP66 for front panel components.

### CLEAN CONNECTIONS

Options for both eight and ten terminal base styles with AMP & Packard compatible connectors affords myriad circuit options while providing ease of assembly.

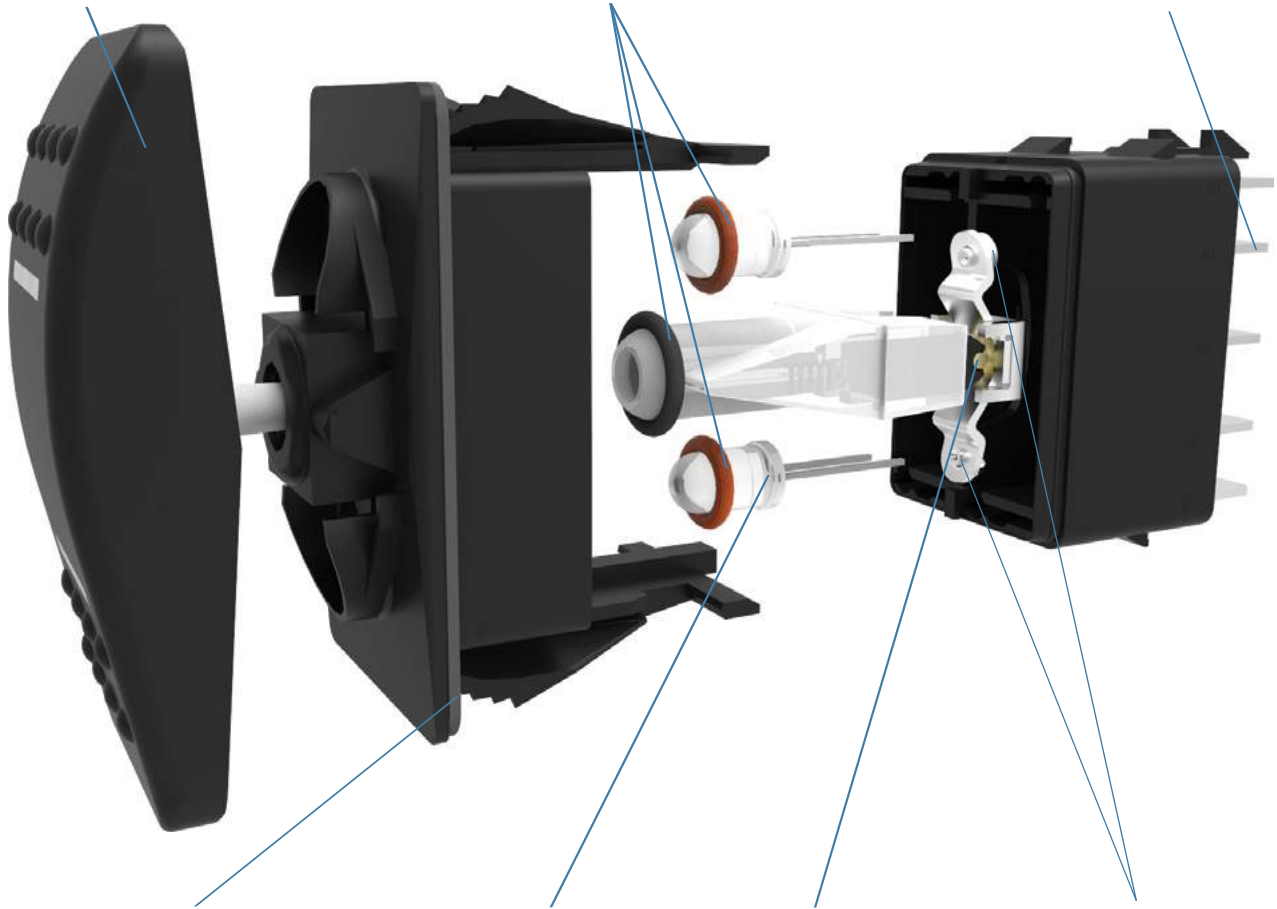

### OPTIONAL PANEL SEAL

Prevents water/dust ingress behind panel.

### MULTIPLE LIGHTING OPTIONS

In addition to Incandescent lamps, our LED illumination is offered in a wide array of light intensities, colors, as well as dual level, tri-color, and flashing options.

### BRASS ROLLER PIN

Robust mechanism eliminates the need for lubricants. Enables switch to withstand -40°C to +85°C temperatures.

### SILVER PLATED BUTT CONTACT MECHANISM

Providing 50k to 100k electrical cycles and a variety of different electrical ratings.



### Contura II & III

The Contura II & III actuators are constructed of thermoplastic polycarbonate and are offered with a hard nylon overlay or a "soft-touch" elastomer overlay. These models incorporate aesthetic designs on the top and bottom of the rocker featuring two rows of raised "bumps" on the Contura II and three "indented" lines on the Contura III.



### Contura X

The raised bracket/bezel on the Contura X helps prevent inadvertent actuation of the rocker, as well as preventing debris from being trapped under the actuator. This curved rocker style is available with a variety of lenses and legends.



### Contura IV

The Contura IV's "Shape to create a Shape" actuator works with the curves, contours & advanced styling of the latest panel designs, flowing with these advanced curves & radii. This actuator style fits on the Contura flush bracket/bezel.



### Contura XI

The raised bracket/bezel on the Contura XI helps prevent inadvertent actuation of the rocker, as well as preventing debris from being trapped under the actuator. This convex style rocker is available with a wide variety of lenses and legends.



### Contura V

The symmetrically curved Contura V actuator provides the perfect complement to the Contura IV's "Shape to create a Shape" design concept. With its flush style mounting bracket, Contura V can be mounted in between two Contura IV's, by itself, or in groups.



### Contura XII

The Contura XII version features a paddle style actuator with the raised bracket/bezel of Contura X and XI. The contoured handle design provides intuitive recognition and ease of operation and is available with all Contura X and XI lens and legend offerings.



### Contura VI (WAVE)

The Contura VI WAVE sealed rocker switches, when used in a row, create a uniquely appealing "wave" design on your panel. A variety of colors and finishes are available for both rocker and wave insert. Contura VI features bar and oval lenses.



### Contura XIV

The Contura XIV represents a sleek new crossover rocker design which should appeal to Trucks, Buses and Heavy Vehicles as well as the Marine Industry. Intuitive feel is provided by recessed ridges along with a Center Groove which effectively defines the boundary between top and bottom switch functions.



### Contura VII

Contura VII featuring gently curved corners and edges assuring compatibility with most any panel design. Intuitive feel is maximized by the use of 2 embossed circular pads located at opposite ends of the rocker. Any combination of Bar or Oval style lenses can be located in the pads providing a truly unique look, exclusive to Contura VII.



### Illuminated Indicators & Accessories

Alert operator of systems functions or malfunctions, are offered with removable/replaceable lamps in Contura II, IV, V or X styles. Accessories include connectors, mounting panels, hole plugs, panel seals, and actuator removal tools. Refer to accessories page for full details



**Electrical**

Contact Rating	.4VA @ 24VDC (MAX) resistive 15 amps, 125VAC 10 amps, 250VAC 1/2 HP 125-250VAC 20 amps, 4-14VDC 15 amps, 15-28VDC 10A, 14VT 6A, 125VAC L
Dielectric Strength	1500 Volts RMS
Insulation Resistance	50 Megohms
Initial Contact Resistance	10 milliohms max. @ 4VDC
Life	50,000 - 100,000 cycles circuit dependent
Contacts	Silver alloy, silver tin-oxide, fine silver
Terminals	Brass or copper/silver plate 1/4" (6.3mm) Quick Connect terminations standard. Solder lug, Wire Lead

**Mechanical**

Endurance	150,000 cycles minimum circuit dependent
-----------	--

**Physical**

Lighted	Incandescent - rated 10,000 hours Neon - rated 25,000 hours LED - rated 100,000 hours 1/2 life (LED is internally ballasted for voltages to 24VDC)
Seals	Internal
Base	Optional external gasket panel seal Polyester blend rated to 125°C with a UL flammability rating of 94V0.
Contura II,III,IV,V, VI, VII Actuator	<b>Hard Surface:</b> Basic actuator structure molded of thermoplastic polycarbonate with a hard Nylon 66 thermoplastic surface overlay. <b>Soft Surface:</b> Basic actuator structure molded of thermoplastic polycarbonate with an elastomer overlay.
Contura X,XI,XII Actuator,VP Lens	Nylon 66 Reinforced rated to 105°C Polycarbonate rated at 100°C
Contura XIV	Polycarbonate lens/sub-rocker with ABS shell

**Actuator Travel (Angular Displacement)**

2 position	18°
3 positions	9° from center

**Mounting Specifications**

Panel Thickness Range

<b>Gaskets</b>	<b>Acceptable Panel Thickness</b>
0	.030 to .250 (.76 to 6.35mm)
1	.030 to .109 & .147 to .157 (.76 to 2.77mm & 3.73 to 3.98mm)

Recommended: No gasket with panel thickness of .032, .062, .093, .125,.187 or .250

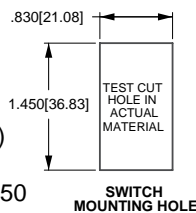

**Agency Certifications**



**Environmental**

Sealing	Sealed version: IP66, this rating applies to front panel components of the actual switch only, and signifies complete protection against dust as well as powerful jets of water.
Corrosion	Mixed Flowing Gas (MFG) Class III 3 year accelerated exposure per ASTM B-827, B-845 Silver and gold contacts
Operating Temp.	-40°C to +85°C
Vibration 1	Per Mil-Std 202F, Method 204D Test Condition A 0.06 DA or 10G's 10-500 Hz. Tested with VCH connector. Test criteria - No loss of circuit during test, pre and post test contact resistance.
Vibration 2	Resonance search 24-50 Hz 0.40 DA 50-2000 Hz ±10 G's peak Horizontal Axis 3-5 G's max. Random 24 Hz 0.06 PSD-Gsq/Hz 60 Hz 0.50 100 Hz 0.50 200 Hz 0.025 2000 Hz 0.025 No loss of circuit during test; <10µ seconds chatter.
Shock	Per Mil-Std 202F, Method 213B, Test Condition K @ 30G's. Tested with VCH connector. Test criteria - No loss of circuit during test, pre and post test contact resistance.
Salt Spray	Per Mil-Std 202F, Method 101D, Test Condition A, 96 Hrs. Sealed version only.
Dust	Per Mil-Std 810C, Method 510.2 Air Velocity 300 ±200 Feet/Min, Test Duration 16 Hrs.
Thermal Shock	Per Mil-Std 202F, Method 107F, Test Cond. A, -55°C to +85°C. Test criteria - pre and post test contact resistance
Moisture Resistance	Per Mil-Std 202F, Method 106F, Test Criteria - pre and post test contact resistance
Ignition Protection	All Contura switches with sealed construction meet the requirements of UL1500/ISO8846 for ignition protection, in addition to conformance with EC directive 94/25/EC for marine products.

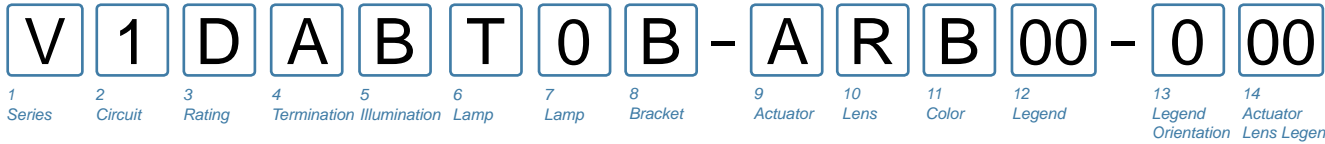

**1 SERIES**  
V

**2 CIRCUIT**  
Terminal Connections as viewed ( ) - momentary from bottom of switch: SP - single pole - uses terminals 1, 2 & 3. 8 terminal 10 terminal DP - double pole uses terminals 1, 2, 3, 4, 5 & 6. Terminals 7, 8, 9 & 10 for lamp circuit only.

8 - -7 8 - -7  
1 - -4 1 - -4  
2 - -5 2 - -5  
3 - -6 3 - -6  
10 - -9

Position:	1	2	3
SP DP	2 & 3, 5 & 6	Connected Terminals	1 & 2, 4 & 5
1 A	ON	NONE	OFF
2 B	(ON)	NONE	OFF
3 C	ON	NONE	(OFF)
4 D	ON	NONE	ON
5 F	ON	NONE	(ON)
6 J	ON	OFF	ON
7 K	ON	OFF	(ON)
8 L	(ON)	OFF	(ON)

**SPECIAL CIRCUITS**

	2 & 3	2 & 3, 5 & 4	5 & 4
H*	2 & 3	2 & 3	OFF
G*	2 & 3, 5 & 6	2 & 3	OFF
S*	2 & 3, 5 & 6	2 & 3	1 & 2
M*	(2 & 3, 5 & 6)	2 & 3	OFF
R*	(2 & 3, 5 & 6)	2 & 3	2 & 1
E*	5 & 6	5 & 3	5 & 1

\*Jumper between terminals 2 & 5 for circuits H,G,M,R & S are specified in selection 4. External jumper between terminals 2 & 4 for circuit E are provided by customer. Circuit E may be used for SP OFF-ON-ON circuit.

**3 RATING**  
1 .4VA @ 28VDC Resistive  
B 15A 24V  
C 20A 18V  
D 20A 12V  
E 20A 14V, 10A 14VT (circuit 1, 4 , A & D only)  
F 10A 14V, 6A 14VT (circuit G only)  
M .4VA/20A 12V  
N .4VA/15A 24V

**4 TERMINATION / BASE STYLE**

8 term	10 Term	Termination	Jumper
1	2	.250 TAB (QC) no barriers	No
A	B	.250 TAB (QC) with barriers	No
J	K	.250 TAB (QC) no barriers	Yes T2 to 5
3	5	Solder Lug no barriers	No
C	D	Solder Lug	No
E	6	Wire Leads no barriers	No
5	F	Wire Leads	No

Note: Codes J & K for circuits H, G & M.

**5 ILLUMINATION**  
Lamp #1: above terminals 1 & 4 end of switch ; Lamp #2 above terminals 3 & 6 end of switch. Positive (+) and negative (-) symbols apply to LED lamps only

Sealed	Unsealed	Lamps	Illumination Type	Lamp wired to Terminals
S	0	NONE		
A	1	1	INDEPENDENT	8 (+) 7 (-)
B	2	1	DOWN	3 (+) 7 (-)
C	3	2	UP	3 (+) 7 (-)
D	4	1	DOWN	3 (+) 7 (-)
		2	DOWN	1 (+) 7 (-)
E	5	1	UP	1 (+) 7 (-)
		2	UP	3 (+) 7 (-)
F	6	1	INDEPENDENT	8 (+) 7 (-)
		2	UP	3 (+) 6 (-)
G	7	1	INDEPENDENT	8 (+) 7 (-)
		2	UP	3 (+) 7 (-)
H	Z	2	INDEPENDENT	8 (+) 7 (-)
U	Y	1	INDEPENDENT	8 (+) 7 (-)
		2	INDEPENDENT	10 (+) 9 (-)

**SINGLE POLE SWITCHES ONLY**

J	8	1	DOWN	3 (+) 8 (-)
		2	INDEPENDENT	6 (+) 7 (-)
K	W	1	INDEPENDENT	8 (+) 7 (-)
		2	INDEPENDENT	6 (+) 7 (-)

**DOUBLE POLE SWITCHES ONLY**

L	9	1	DOWN	3 (+) 6 (-)
M	R	1	UP	3 (+) 6 (-)
N	T	1	DOWN	3 (+) 6 (-)
		2	DOWN	1 (+) 4 (-)
P	V	1	UP	1 (+) 4 (-)
		2	UP	3 (+) 6 (-)

**6,7 LAMP (SAME CODING FOR BOTH SELECTIONS)**  
Selection 6: above terminals 1 & 4; Selection 7: above terminals 3 & 6

No lamp 0  
Neon 1 125VAC 2 250VAC  
Incandescent 4 3V 5 6V 6 12V 7 18V 8 24V  
LED\*  
Red Amber Green superbright Red  
A L F R  
6VDC B M G S  
12VDC C N H T  
24VDC D P J V

Consult factory for "daylight bright" LED options. Typical current draw for LED is 20ma.

**8 FLUSH BRACKET COLOR 1, PANEL SEAL**

	Black	White	Gray
No Seal	B	W	G
One Seal	C	Y	H

**9 ACTUATOR**

0 No Actuator  
A, B Contura II  
C, D Contura III

Actuator orientation above terminals: 3,6 1,4

**10 LENS**

0 - No Actuator Z - No Lens  
Clear White Amber Green Red Blue

	6	8	G	M	T
1	6	8	G	M	T
2	7	C	H	N	U
3	8	D	J	P	V
4	9	E	K	R	W
5	A	F	L	S	Y

Lens color for LEDs must be clear, white, or match color of LED. Green or blue lenses are not recommended with Neon lamps.

**11 ACTUATOR COLOR 1 AND TEXTURE**

0 - No Actuator

	Black	Gray	Red	White
Soft Surface	B	G	R	W
Hard Surface	C	H	S	Y

**12 ACTUATOR LENS OR BODY LEGENDS 2**

11 ON 12 OFF 13 I 14 O  
OFF ON O I

15 O O 16 O O 17 O I 18 I O  
F N N F

For additional legend options & codes, visit us at [www.carlingtech.com](http://www.carlingtech.com).

**13 LEGEND ORIENTATION**

0 No legend (used with codes 11-18 in selection 12)  
1 Orientation 1  
2 Orientation 2  
3 Orientation 3  
4 Orientation 4

**14 ACTUATOR LENS LEGEND**

00 No legend this location / no actuator (used with codes 11-18 in selection 12) Selection 14 required when switch requires two legends. If the two legends consist of one lens and one body legend, lens legend must be specified in selection 12; body legend specified in selection 14.  
For legend options & codes, visit us at [www.carlingtech.com](http://www.carlingtech.com).

- Notes:
- Consult factory to verify horsepower rating for your particular circuit choice.
  - Custom colors are available. Consult factory.
  - Body legends not available on Soft surface actuators; White imprinting is standard on black actuators; Black imprinting is standard on white, red and gray actuators. Custom colors are available, consult factory.
  - Additional ratings available. See V-Series Switch Accessories page.
  - Contura II available with two square lenses. Consult factory for details.

**V 1 D A S W O B - A Z E 00 - 0**

1 Series    2 Circuit    3 Rating    4 Termination    5 Illumination    6 Lock    7 Lamp    8 Bracket    9 Actuator    10 Lens    11 Function    12 Legend    13 Legend Orientation

**1 SERIES**  
**V**

**2 CIRCUIT**

Terminal Connections as viewed ( ) - momentary from bottom of switch: SP - single pole - uses terminals 1, 2 & 3. 8 terminal 10 terminal DP - double pole uses terminals 1, 2, 3, 4, 5 & 6. Terminals 7, 8, 9 & 10 for lamp circuit only.

8 - - 7    8 - - 7  
1 - - 4    1 - - 4  
2 - - 5    2 - - 5  
3 - - 6    3 - - 6  
10 - - 9

Position:	1	2	3
SP DP	2 & 3, 5 & 6	Connected	Terminals 1 & 2, 4 & 5
1 A	ON	NONE	OFF
4 D	ON	NONE	ON
6 J	ON	OFF	ON
7 K	(ON)	OFF	(ON)
8 L	(ON)	OFF	(ON)
9 N	OFF	NONE	ON

**SPECIAL CIRCUITS**

	2 & 3	2 & 3, 5 & 4	5 & 4
H*	2 & 3, 5 & 6	2 & 3	OFF
G*	2 & 3, 5 & 6	2 & 3	1 & 2
S*	(2 & 3, 5 & 6)	2 & 3	OFF
M*	(2 & 3, 5 & 6)	2 & 3	2 & 1
R*	5 & 6	5 & 3	5 & 1
E*			

\*Jumper between terminals 2 & 5 for circuits H, G, M, R & S are specified in selection 4. External jumper between terminals 2 & 4 for circuit E are provided by customer. Circuit E may be used for SP OFF-ON-ON circuit.

**3 RATING 4**

- 1 .4VA @ 28VDC Resistive
- B 15A 24V
- C 20A 18V
- D 20A 12V
- E 20A 14V, 10A 14VT (circuit 1, 4, A & D only)
- F 10A 14V, 6A 14VT (circuit G only)
- M .4VA/20A 12V
- N .4VA/15A 24V

**4 TERMINATION / BASE STYLE**

8 term	10 Term	Termination	Jumper
1	2	.250 TAB (QC) no barriers	No
A	B	.250 TAB (QC) with barriers	No
J	K	.250 TAB (QC) no barriers	Yes T2 to 5
3	5	Solder Lug no barriers	No
C	D	Solder Lug	No
5	6	Wire Leads no barriers	No
E	F	Wire Leads	No

Note: Codes J & K for circuits H, G & M.

**5 ILLUMINATION & SWITCH SEALING**

Lamp #1: above terminals 1 & 4 end of switch.; Lamp #2 above terminals 3 & 6 end of switch. Positive (+) and negative (-) symbols apply to LED lamps only

Sealed	Unsealed	Lamps	Illumination Type	Lamp wired to Terminals
S	0	NONE	-	-
C	3	2	UP	3 (+) 7 (-)
H	Z	2	INDEPENDENT	8 (+) 7 (-)

**DOUBLE POLE SWITCHES ONLY**

M	R	1	UP	3 (+) 6 (-)
---	---	---	----	-------------

**6 LOCK**

Lock above terminals 1 & 4 end of switch  
**W** lock

**7 LAMP**

Lamp above terminals 3 & 6 end of switch

No lamp	0				
Neon	1	125VAC	2	250VAC	
Incandescent LED*	4	3V	5	6V	
		Red		Amber	
2VDC	A		L		6
6VDC	B		M		12V superbright
12VDC	C		N		Green
24VDC	D		P		F
					H
					J
					R
					S
					T
					V

\* Consult factory for "daylight bright" LED options. Typical current draw for LED is 20ma.

**8 FLUSH BRACKET COLOR 1, PANEL SEAL**

No Seal	Black	White	Gray
One Seal	B	W	G
	C	Y	H

**9 HARD SURFACE ACTUATOR 1**

Contura II	Black	Gray	Red	White
	A	B	G	H
Contura III	C	D	E	F

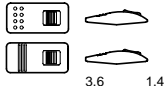
Actuator orientation above terminals: 

**10 LENS**

Z - No Lens				
Clear White	3	8	D	
Amber			J	
Green				
Red			P	
Blue				V

Lens color for LEDs must be clear, white, or match color of LED. Green or blue lenses are not recommended with Neon lamps.

**11 ACTUATOR LOCK FUNCTION AND COLOR 1**

Lock Color	Up	Down	Up & Down	Center 3
Match Actuator	A	H	R	1
Black	B	J	S	2
White	C	K	T	3
Red	D	L	V	4
Safety Orange	E	M	W	5

**12 ACTUATOR LENS OR BODY LEGEND 2**

00 - No Legend				
21	22	23	24	
OFF	ON	O	I	
25	26	27	28	
O	O	O	I	
F	N			

For additional legend options & codes, visit us at [www.carlingtech.com](http://www.carlingtech.com).

**13 LEGEND ORIENTATION**

0	No legend (used with codes 21-28 in selection 12)
1	Orientation 1
2	Orientation 2
3	Orientation 3
4	Orientation 4

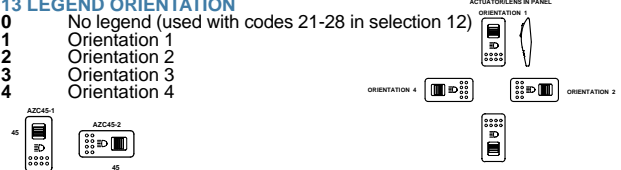

**Notes:**

- 1 Consult factory to verify horsepower rating for your particular circuit choice.
- 2 Custom colors are available. Consult factory.
- 3 White imprinting is standard on black actuators; Black imprinting is standard on white, red and gray actuators. Custom colors are available, consult factory.
- 4 Only available with 3 position circuits. Center OFF and special circuits only available with center position lock function.
- 5 Additional ratings available. See V-Series Switch Accessories page.

V 1 D A B T O B - E P C 00 - 0 00

1 Series 2 Circuit 3 Rating 4 Termination Illumination 5 Lamp 6 Lamp 7 Lamp 8 Bracket 9 Actuator 10 Lens 11 Color 12 Legend 13 Legend Orientation 14 Actuator Lens Legend

**1 SERIES**  
V

**2 CIRCUIT**  
Terminal Connections as viewed ( ) - momentary from bottom of switch: SP - single pole - uses terminals 1, 2 & 3. 8 terminal 10 terminal DP - double pole uses terminals 1, 2, 3, 4, 5 & 6. 8 - 7 8 - 7 Terminals 7, 8, 9 & 10 for lamp circuit only. 1 - 4 1 - 4 2 - 5 2 - 5 3 - 6 3 - 6 10 - 9

Position:	1	2	3
SP	2 & 3, 5 & 6	Connected Terminals	1 & 2, 4 & 5
1	A ON	NONE	OFF
2	B (ON)	NONE	OFF
3	C ON	NONE	(OFF)
4	D ON	NONE	ON
5	F ON	NONE	(ON)
6	J ON	OFF	ON
7	K ON	OFF	ON
8	L (ON)	OFF	(ON)

SPECIAL CIRCUITS	2 & 3	2 & 3, 5 & 4	5 & 4
H*	2 & 3	2 & 3, 5 & 4	5 & 4
G*	2 & 3, 5 & 6	2 & 3	OFF
S*	2 & 3, 5 & 6	2 & 3	1 & 2
M*	(2 & 3, 5 & 6)	2 & 3	OFF
R*	(2 & 3, 5 & 6)	2 & 3	2 & 1
E*	5 & 6	5 & 3	5 & 1

\*Jumper between terminals 2 & 5 for circuits H,G,M,R & S are specified in selection 4. External jumper between terminals 2 & 4 for circuit E are provided by customer. Circuit E may be used for SP OFF-ON-ON circuit.

**3 RATING 4**  
1 .4VA @ 28VDC Resistive  
B 15A 24V  
C 20A 18V  
D 20A 12V  
E 20A 14V, 10A 14VT (circuit 1, 4, A & D only)  
F 10A 14V, 6A 14VT (circuit G only)  
M .4VA/20A 12V  
N .4VA/15A 24V

**4 TERMINATION / BASE STYLE**

8 term	10 Term	Termination	Jumper
1	2	.250 TAB (QC) no barriers	No
A	B	.250 TAB (QC) with barriers	No
J	K	.250 TAB (QC) no barriers	Yes T2 to 5
3	5	Solder Lug no barriers	No
C	D	Solder Lug	No
5	6	Wire Leads no barriers	No
E	F	Wire Leads	No

Note: Codes J & K for circuits H, G & M.

**5 ILLUMINATION & SWITCH SEALING**  
Lamp #1: above terminals 1 & 4 end of switch.; Lamp #2 above terminals 3 & 6 end of switch. Positive (+) and negative (-) symbols apply to LED lamps only

Sealed	Unsealed	Lamps	Illumination Type	Lamp wired to Terminals
S	0	NONE	-	-
A	1	1	INDEPENDENT	8 (+) 7 (-)
B	2	1	DOWN	3 (+) 7 (-)
C	3	2	UP	3 (+) 7 (-)
D	4	1	DOWN	3 (+) 7 (-)
E	5	2	DOWN	1 (+) 7 (-)
F	6	2	UP	1 (+) 7 (-)
G	7	1	INDEPENDENT	8 (+) 7 (-)
H	Z	2	UP	3 (+) 7 (-)
U	Y	2	INDEPENDENT	8 (+) 7 (-)
		2	INDEPENDENT	10 (+) 9 (-)

**SINGLE POLE SWITCHES ONLY**  
J 8 1 DOWN 3 (+) 8 (-)  
K W 2 INDEPENDENT 6 (+) 7 (-)  
N T 1 INDEPENDENT 8 (+) 7 (-)  
P V 2 INDEPENDENT 6 (+) 7 (-)

**DOUBLE POLE SWITCHES ONLY**  
L 9 1 DOWN 3 (+) 6 (-)  
M R 1 UP 3 (+) 6 (-)  
N T 1 DOWN 3 (+) 6 (-)  
P V 2 DOWN 1 (+) 4 (-)  
P V 1 UP 1 (+) 4 (-)  
P V 2 UP 3 (+) 6 (-)

**6,7 LAMP (SAME CODING FOR BOTH SELECTIONS)**  
Selection 6: above terminals 1 & 4; Selection 7: above terminals 3 & 6  
No lamp 0  
Neon 1 125VAC 2 250VAC  
Incandescent 4 3V 5 6V 6 12V superbright 7 18V superbright 8 24V LED\*  
2VDC Red A Amber L Green F  
6VDC B M 12VDC C N 24VDC D P  
\* Consult factory for "daylight bright" LED options. Typical current draw for LED is 20ma.

**8 FLUSH BRACKET COLOR 1, PANEL SEAL**  
No Seal Black B White W Gray G  
One Seal C Y H

**9 ACTUATOR**  
0 No Actuator 1,4  
T Contura IV, left orientation  
E Contura IV, left orientation, laser etched  
F Contura IV, right orientation  
R Contura IV, right orientation, laser etched  
Actuator orientation above terminals:  
3,6

**10 LENS**  
0 - No Actuator Z - No Lens  
Clear White Amber Green Red Blue  
1 6 8 G M T  
2 7 C H N U  
3 8 D J P V  
4 9 E K R W  
5 A F L S Y  
E F  
Lens color for LEDs must be clear, white, or match color of LED. Green or blue lenses are not recommended with Neon lamps.

**11 ACTUATOR COLOR 1,5,6**  
No Actuator 0 Black C Gray H Red S  
White Y Nickel D Pewter E

**12 ACTUATOR LENS OR BODY LEGENDS 2**  
11 ON 12 OFF 13 I 14 O  
OFF ON O I  
15 O O 16 O O 17 O I 18 I O  
F N N F  
F F  
For additional legend options & codes, visit us at www.carlingtech.com.

**13 LEGEND ORIENTATION**  
0 No legend (used with codes 11-18 in selection 12)  
1 Orientation 1  
2 Orientation 2  
3 Orientation 3  
4 Orientation 4  
ESC70-200 ESC70-300 ESC45-100 ESC45-300  
FSC45-100 FSC70-200 FSC45-300  
ORIENTATION 1 ORIENTATION 2 ORIENTATION 3 ORIENTATION 4

**14 ACTUATOR LENS LEGEND**  
00 No legend this location / no actuator (used with codes 11-18 in selection 12) Selection 14 required when switch requires two legends. If the two legends consist of one lens and one body legend, lens legend must be specified in selection 12; body legend specified in selection 14. For legend options & codes, visit us at www.carlingtech.com.

Notes:  
Consult factory to verify horsepower rating for your particular circuit choice.  
1 Custom colors are available. Consult factory.  
2 White imprinting is standard on black actuators; Black imprinting is standard on white, red and gray actuators. Custom colors are available, consult factory.  
3 Gloss brow is on left side of E actuator and right side of F actuator.  
4 Additional ratings available. See V-Series Switch Accessories page.  
5 Laser etched rocker only available with lens code Z & actuator colors black, nickel or pewter.  
6 Pewter and nickel colors only available with laser etched actuator.

V 1 D A B T O B - G P C 00 - 0 00

1 Series 2 Circuit 3 Rating 4 Termination Illumination 5 Lamp 6 Lamp 7 Lamp 8 Bracket 9 Actuator 10 Lens 11 Color 12 Legend 13 Legend Orientation 14 Actuator Lens Legend

**1 SERIES**

V

**2 CIRCUIT**

Terminal Connections as viewed ( ) - momentary from bottom of switch: SP - single pole - uses terminals 1, 2 & 3. DP - double pole uses terminals 1, 2, 3, 4, 5 & 6. 8 terminal 10 terminal Terminals 7, 8, 9 & 10 for lamp circuit only.

1 - -4 1 - -4  
2 - -5 2 - -5  
3 - -6 3 - -6  
10 - -9

Position:	1	2	3
SP DP	2 & 3, 5 & 6	Connected Terminals	1 & 2, 4 & 5
1 A	ON	NONE	OFF
2 B	(ON)	NONE	OFF
3 C	(ON)	NONE	(OFF)
4 D	ON	NONE	ON
5 F	ON	NONE	(ON)
6 J	ON	OFF	ON
7 K	ON	OFF	(ON)
8 L	(ON)	OFF	(ON)

**SPECIAL CIRCUITS**

H*	2 & 3	2 & 3, 5 & 4	5 & 4
G*	2 & 3, 5 & 6	2 & 3	OFF
S*	2 & 3, 5 & 6	2 & 3	1 & 2
M*	(2 & 3, 5 & 6)	2 & 3	OFF
R*	(2 & 3, 5 & 6)	2 & 3	2 & 1
E*	5 & 6	5 & 3	5 & 1

\*Jumper between terminals 2 & 5 for circuits H, G, M, R & S are specified in selection 4. External jumper between terminals 2 & 4 for circuit E are provided by customer. Circuit E may be used for SP OFF-ON-ON circuit.

**3 RATING 4**

1	.4VA @ 28VDC Resistive
B	15A 24V
C	20A 18V
D	20A 12V
E	20A 14V, 10A 14VT (circuit 1, 4, A & D only)
F	10A 14V, 6A 14VT (circuit G only)
M	.4VA/20A 12V
N	.4VA/15A 24V

**4 TERMINATION / BASE STYLE**

8 term	10 Term	Termination	Jumper
1	2	.250 TAB (QC) no barriers	No
A	B	.250 TAB (QC) with barriers	No
J	K	.250 TAB (QC) no barriers	Yes T2 to 5
3	5	Solder Lug no barriers	No
C	D	Solder Lug	No
5	6	Wire Leads no barriers	No
E	F	Wire Leads	No

Note: Codes J & K for circuits H, G & M.

**5 ILLUMINATION & SWITCH SEALING**

Lamp #1: above terminals 1 & 4 end of switch.; Lamp #2 above terminals 3 & 6 end of switch. Positive (+) and negative (-) symbols apply to LED lamps only

Sealed	Unsealed	Lamps	Illumination Type	Lamp wired to Terminals
S	0	NONE	-	-
A	1	1	INDEPENDENT	8 (+) 7 (-)
B	2	1	DOWN	3 (+) 7 (-)
C	3	2	UP	3 (+) 7 (-)
D	4	1	DOWN	3 (+) 7 (-)
		2	DOWN	1 (+) 7 (-)
E	5	1	UP	1 (+) 7 (-)
		2	UP	3 (+) 7 (-)
F	6	1	INDEPENDENT	8 (+) 7 (-)
		2	UP	3 (+) 6 (-)
G	7	1	INDEPENDENT	8 (+) 7 (-)
		2	UP	3 (+) 7 (-)
H	Z	2	INDEPENDENT	8 (+) 7 (-)
U	Y	1	INDEPENDENT	8 (+) 7 (-)
		2	INDEPENDENT	10 (+) 9 (-)

**SINGLE POLE SWITCHES ONLY**

J	8	1	DOWN	3 (+) 8 (-)
		2	INDEPENDENT	6 (+) 7 (-)
K	W	1	INDEPENDENT	8 (+) 7 (-)
		2	INDEPENDENT	6 (+) 7 (-)

**DOUBLE POLE SWITCHES ONLY**

L	9	1	DOWN	3 (+) 6 (-)
M	R	1	UP	3 (+) 6 (-)
N	T	1	DOWN	3 (+) 6 (-)
		2	DOWN	1 (+) 4 (-)
P	V	1	UP	1 (+) 4 (-)
		2	UP	3 (+) 6 (-)

**6,7 LAMP (SAME CODING FOR BOTH SELECTIONS)**

Selection 6: above terminals 1 & 4; Selection 7: above terminals 3 & 6

No lamp	0	2 250VAC			
Neon	1 125VAC	2 250VAC			
Incandescent LED*	4 3V	5 6V	6 12V superbright	7 18V superbright	8 24V superbright
	Red	Amber	Green	Red	
2VDC	A	L	F	R	
6VDC	B	M	G	S	
12VDC	C	N	H	T	
24VDC	D	P	J	V	

\* Consult factory for "daylight bright" LED options. Typical current draw for LED is 20ma.

**8 FLUSH BRACKET COLOR 1, PANEL SEAL**

	Black	White	Gray
No Seal	B	W	G
One Seal	C	Y	H

**9 ACTUATOR**

0	No Actuator
G	Contura V
P	Contura V, laser etched

**10 Lens**

0 - No Actuator	Z - No Lens	style & location: #1 / #2
Clear White	Amber	Green
1 6	8	G M T bar
2 7	C	H N U bar/bar
3 8	D	J P V oval
4 9	E	K R W oval/bar
5 A	F	L S Y oval/oval

Lens color for LEDs must be clear, white, or match color of LED. Green or blue lenses are not recommended with Neon lamps.

**11 ACTUATOR COLOR 1,3,5**

No Actuator	0	Black	C	Gray	H	Red	S
White	Y	Nickel	D	Pewter	E		

**12 ACTUATOR LENS OR BODY LEGENDS 2,6**

11 ON	12 OFF	13 I	14 O
OFF	ON	O	I
15 O O	16 O O	17 O I	18 I O
F N	N F		
F	F		

For additional legend options & codes, visit us at [www.carlingtech.com](http://www.carlingtech.com).

**13 LEGEND ORIENTATION**

0	No legend (used with codes 11-18 in selection 12)
1	Orientation 1
2	Orientation 2
3	Orientation 3
4	Orientation 4

**14 ACTUATOR LENS LEGEND**

00 No legend this location / no actuator (used with codes 11-18 in selection 12) Selection 14 required when switch requires two legends. If the two legends consist of one lens and one body legend, lens legend must be specified in selection 12; body legend specified in selection 14. For legend options & codes, visit us at [www.carlingtech.com](http://www.carlingtech.com).

**Notes:**

- Consult factory to verify horsepower rating for your particular circuit choice.
- Custom colors are available. Consult factory.
- White imprinting is standard on black actuators; Black imprinting is standard on white, red and gray actuators. Custom colors are available, consult factory.
- Laser Etched rocker only available with lens code Z & actuator colors black, nickel or pewter.
- Additional ratings available. See V-Series Switch Accessories page.
- Nickel and Pewter colors only available with laser etched actuator.
- Consult factory for laser etched lens callout.

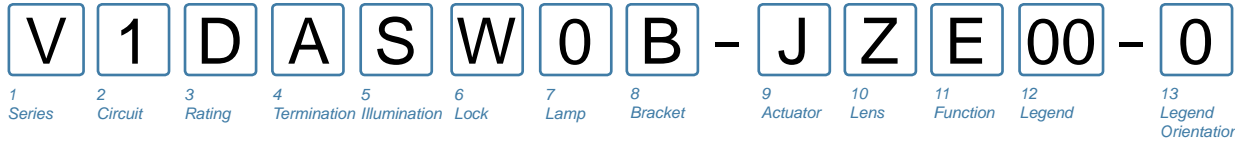

**1 SERIES**  
V

**2 CIRCUIT<sup>3</sup>**  
Terminal Connections as viewed from bottom of switch: ( ) - momentary SP - single pole - uses terminals 1, 2 & 3. DP - double pole uses terminals 1, 2, 3, 4, 5 & 6. Terminals 7, 8, 9 & 10 for lamp circuit only.

8 - -7	8 - -7	1 - -4	1 - -4
2 - -5	2 - -5	3 - -6	3 - -6
10 - -9	10 - -9		

**Position:**

SP DP	2 & 3, 5 & 6	Connected Terminals	1 & 2, 4 & 5
1 A	ON	NONE	OFF
4 D	ON	NONE	ON
6 J	ON	OFF	ON
7 K	ON	OFF	(ON)
8 L	(ON)	OFF	(ON)
9 N	OFF	NONE	ON

**3 RATING<sup>4</sup>**

1	.4VA @ 28VDC Resistive
B	15A 24V
C	20A 18V
D	20A 12V
E	20A 14V, 10A 14VT (circuit 1, 4, A & D only)
F	10A 14V, 6A 14VT (circuit G only)
M	.4VA/20A 12V
N	.4VA/15A 24V

**4 TERMINATION / BASE STYLE**

8 term	10 Term	Termination	Jumper
1 A	2 B	.250 TAB (QC) no barriers	No
J	K	.250 TAB (QC) with barriers	No
3	5	.250 TAB (QC) no barriers	Yes T2 to 5
C	D	Solder Lug no barriers	No
5	6	Solder Lug	No
E	F	Wire Leads no barriers	No
		Wire Leads	No

Note: Codes J & K for circuits H, G & M.

**5 ILLUMINATION & SWITCH SEALING**

Lamp #1: above terminals 1 & 4 end of switch.; Lamp #2 above terminals 3 & 6 end of switch. Positive (+) and negative (-) symbols apply to LED lamps only

Sealed	Unsealed	Lamps	Illumination Type	Lamp wired to Terminals
S	0	NONE	-	-
C	3	2	UP	3 (+) 7 (-)
H	Z	2	INDEPENDENT	8 (+) 7 (-)

**DOUBLE POLE SWITCHES ONLY**

M	R	1	UP	3 (+) 6 (-)
---	---	---	----	-------------

**6 LOCK**  
Lock above terminals 1 & 4 end of switch.  
W low profile lock Y 6 high profile lock

- Notes:  
Consult factory to verify horsepower rating for your particular circuit choice.
- 1 Custom colors are available. Consult factory.
  - 2 White imprinting is standard on black actuators; Black imprinting is standard on white, red and gray actuators. Custom colors are available, consult factory.
  - 3 Only available with 3 position circuits. Center OFF and special circuits only available with center position lock function.
  - 4 Additional ratings available. See V-Series Switch Accessories page.
  - 5 Located at T3-6 end of switch.
  - 6 Contura V style only.

**7 LAMP**  
Lamp above terminals 3 & 6 end of switch

No lamp	0				
Neon	1	125VAC	2	250VAC	
Incandescent LED*	4	3V	5	6V	
		Red		Amber	6 12V superbright Green
2VDC	A		L		7 18V superbright Red
6VDC	B		M		R
12VDC	C		N		S
24VDC	D		P		T
					V

\* Consult factory for "daylight bright" LED options. Typical current draw for LED is 20ma.

**8 FLUSH BRACKET COLOR<sup>1</sup>, PANEL SEAL**

No Seal	Black	White	Gray
One Seal	B	W	G
	C	Y	H

**9 HARD SURFACE ACTUATOR**

CONTURA IV:  
Orientation: Black (J), Gray (K), Red (L), White (M)  
Left (J, K, L, M), Right (N, P, R, S)

CONTURA V:  
Orientation: Black (U), Gray (V), Red (W), White (Y)

Actuator orientation above terminals: 3, 6, 1, 4

**10 LENS<sup>5</sup>**  
Z - No Lens

Clear	White	Amber	Green	Red	Blue
A	B	C	D	E	F
G	H	J	K	L	M

bar lens (A-F), oval lens (G-M)

Lens color for LEDs must be clear, white, or match color of LED. Green or blue lenses are not recommended with Neon lamps.

**11 ACTUATOR LOCK FUNCTION AND COLOR<sup>1</sup>**

Lock Color	Up	Down	Up & Down	Center <sup>3</sup>
Match Actuator	A	H	R	1
Black	B	J	S	2
White	C	K	T	3
Red	D	L	V	4
Safety Orange	E	M	W	5
Gray	F	G	N	6

**12 ACTUATOR LENS OR BODY LEGEND<sup>2</sup>**

00 - No Legend

21	22	23	24
OFF	ON	O	I
25	26	27	28
O	O	O	I
F	N		

For additional legend options & codes, visit us at [www.carlingtech.com](http://www.carlingtech.com).

**13 LEGEND ORIENTATION**

0 No legend  
1 Orientation 1  
2 Orientation 2  
3 Orientation 3  
4 Orientation 4

V 1 D B G N T B - H A 7 C B A C - 1 00

1 Series 2 Circuit 3 Rating 4 Termination Illumination Lamp 5 Lamp 6 Bracket 7 Actuator 8 Lens 9 Lens 10 Color 11 Insert Color 12 Actuator Lens 13 Actuator Lens 14 Legend Orientation Lens Legend 15 Actuator Lens Legend 16

**1 SERIES**

V

**2 CIRCUIT**

Terminal Connections as viewed ( ) - momentary from bottom of switch: SP - single pole - uses terminals 1, 2 & 3. 8 terminal 10 terminal DP - double pole uses terminals 1, 2, 3, 4, 5 & 6. 8 - -7 8 - -7 Terminals 7, 8, 9 & 10 for lamp circuit only. 1 - -4 1 - -4 2 - -5 2 - -5 3 - -6 3 - -6 10 - -9

Position:	1	2	3
SP DP	2 & 3, 5 & 6	Connected Terminals	1 & 2, 4 & 5
1 A	ON	NONE	OFF
2 B	(ON)	NONE	(OFF)
3 C	ON	NONE	(OFF)
4 D	ON	NONE	ON
5 F	ON	NONE	(ON)
6 J	ON	OFF	ON
7 K	ON	OFF	(ON)
8 L	(ON)	OFF	(ON)

**SPECIAL CIRCUITS**

H*	2 & 3	2 & 3, 5 & 4	5 & 4
G*	2 & 3, 5 & 6	2 & 3	OFF
S*	2 & 3, 5 & 6	2 & 3	1 & 2
M*	(2 & 3, 5 & 6)	2 & 3	OFF
R*	(2 & 3, 5 & 6)	2 & 3	2 & 1
E*	5 & 6	5 & 3	5 & 1

\*Jumper between terminals 2 & 5 for circuits H,G,M,R & S are specified in selection 4. External jumper between terminals 2 & 4 for circuit E are provided by customer. Circuit E may be used for SP OFF-ON-ON circuit.

**3 RATING 3**

1	.4VA @ 28VDC Resistive
B	15A 24V
C	20A 18V
D	20A 12V
E	20A 14V, 10A 14VT (circuit 1, 4, A & D only)
F	10A 14V, 6A 14VT (circuit G only)
M	.4VA/20A 12V
N	.4VA/15A 24V

**4 TERMINATION / BASE STYLE**

8 term	10 Term	Termination	Jumper
1	2	.250 TAB (QC) no barriers	No
A	B	.250 TAB (QC) with barriers	No
J	K	.250 TAB (QC) no barriers	Yes T2 to 5
3	5	Solder Lug no barriers	No
C	D	Solder Lug	No
5	6	Wire Leads no barriers	No
E	F	Wire Leads	No

Note: Codes J & K for circuits H, G & M.

**5 ILLUMINATION & SWITCH SEALING**

Lamp #1: above terminals 1 & 4 end of switch.; Lamp #2 above terminals 3 & 6 end of switch. Positive (+) and negative (-) symbols apply to LED lamps only

Sealed	Unsealed	Lamps	Illumination Type	Lamp wired to Terminals
S	0	NONE	-	-
A	1	1	INDEPENDENT	8 (+) 7 (-)
B	2	1	DOWN	3 (+) 7 (-)
C	3	2	UP	3 (+) 7 (-)
D	4	1	DOWN	3 (+) 7 (-)
		2	DOWN	1 (+) 7 (-)
E	5	1	UP	1 (+) 7 (-)
		2	UP	3 (+) 7 (-)
F	6	1	INDEPENDENT	8 (+) 7 (-)
		2	UP	3 (+) 6 (-)
G	7	1	INDEPENDENT	8 (+) 7 (-)
		2	UP	3 (+) 7 (-)
H	Z	2	INDEPENDENT	8 (+) 7 (-)
U	Y	1	INDEPENDENT	8 (+) 7 (-)
		2	INDEPENDENT	10 (+) 9 (-)
<b>SINGLE POLE SWITCHES ONLY</b>				
J	8	1	DOWN	3 (+) 8 (-)
		2	INDEPENDENT	6 (+) 7 (-)
K	W	1	INDEPENDENT	8 (+) 7 (-)
		2	INDEPENDENT	6 (+) 7 (-)
<b>DOUBLE POLE SWITCHES ONLY</b>				
L	9	1	DOWN	3 (+) 6 (-)
M	R	1	UP	3 (+) 6 (-)
N	T	1	DOWN	3 (+) 6 (-)
		2	DOWN	1 (+) 4 (-)
P	V	1	UP	1 (+) 4 (-)
		2	UP	3 (+) 6 (-)

**7 LAMP**

Lamp above terminals 3 & 6 end of switch

No lamp	0				
Neon	1 125VAC	2 250VAC			
Incandescent LED*	4 3V	5 6V	6 12V superbright Green	7 18V superbright Red	8 24V
	Red	Amber			
2VDC	A	L	F	R	
6VDC	B	M	G	S	
12VDC	C	N	H	T	
24VDC	D	P	J	V	

\* Consult factory for "daylight bright" LED options. Typical current draw for LED is 20ma.

**8 FLUSH BRACKET COLOR 1, PANEL SEAL**

No Seal	Black	White	Gray
One Seal	B	W	G
	C	Y	H

**9 ACTUATOR**

0	No Actuator	H	High Insert	L	Low Insert
---	-------------	---	-------------	---	------------

**10,11 LENS 4**

0 - No Actuator	Z - No Lens					
Clear	White	Amber	Green	Red	Blue	
-	7	C	H	N	U	Bar Lens Translucent
3	-	D	J	P	V	Bar Lens Transparent
4	-	E	K	R	W	Oval Lens Transparent
-	A	F	L	S	Y	Oval Lens Translucent

Lens color for LEDs must be clear, white, or match color of LED. Green or blue lenses are not recommended with Neon lamps.

**12 ACTUATOR COLOR**

C	Black	H	Gray	S	Red	Y	White
---	-------	---	------	---	-----	---	-------

**13 INSERT COLOR**

N	Bright Nickel Plated
B	Black
S	Satin Chrome Plated
C	Bright Chrome Plated
T	Satin Nickel Plated
D	Satin Chrome Painted
W	White

**14 ACTUATOR LENS OR BODY LEGENDS 2**

00	No Legend this location/No actuator
11	ON 12 OFF 13 I 14 O
	OFF ON O I
15	O O 16 O O 17 O I 18 I O
	F N N F
	F F

For additional legend options & codes, visit us at [www.carlingtech.com](http://www.carlingtech.com).

**15 LEGEND ORIENTATION**

0	No legend (used with codes 11-18 in selection 12)
1	Orientation 1
2	Orientation 2
3	Orientation 3
4	Orientation 4



**16 ACTUATOR LENS LEGEND**

00 No legend this location / no actuator (used with codes 11-18 in selection 12) Selection 14 required when switch requires two legends. If the two legends consist of one lens and one body legend, lens legend must be specified in selection 12; body legend specified in selection 14. For legend options & codes, visit us at [www.carlingtech.com](http://www.carlingtech.com).

**Notes:**

- Consult factory to verify horsepower rating for your particular circuit choice.
- 1 Custom colors are available. Consult factory.
- 2 White imprinting is standard on black actuators. Black imprinting is standard on white, red and gray actuators. Custom colors are available, consult factory.
- 3 Additional ratings available. See V-Series Switch Accessories page.



V 1 D A B T O B - Z R C 00 - 0 00

1 Series 2 Circuit 3 Rating 4 Termination Illumination Lamp 5 Lamp 6 Lamp 7 Lamp 8 Bracket 9 Actuator 10 Lens 11 Color 12 Legend 13 Legend Orientation 14 Actuator Lens Legend

**1 SERIES**

V

**2 CIRCUIT**

Terminal Connections as viewed ( ) - momentary from bottom of switch: SP - single pole - uses terminals 1, 2 & 3. 8 terminal 10 terminal DP - double pole uses terminals 1, 2, 3, 4, 5 & 6. 8 - -7 8 - -7 Terminals 7, 8, 9 & 10 for lamp circuit only. 1 - -4 1 - -4 2 - -5 2 - -5 3 - -6 3 - -6 10 - -9

Position:	1	2	3
SP DP	2 & 3, 5 & 6	Connected Terminals	1 & 2, 4 & 5
1 A	ON	NONE	OFF
2 B	(ON)	NONE	(OFF)
3 C	ON	NONE	(OFF)
4 D	ON	NONE	ON
5 F	ON	NONE	(ON)
6 J	ON	OFF	ON
7 K	ON	OFF	(ON)
8 L	(ON)	OFF	(ON)

**SPECIAL CIRCUITS**

H*	2 & 3	2 & 3, 5 & 4	5 & 4
G*	2 & 3, 5 & 6	2 & 3	OFF
S*	2 & 3, 5 & 6	2 & 3	1 & 2
M*	(2 & 3, 5 & 6)	2 & 3	OFF
R*	(2 & 3, 5 & 6)	2 & 3	2 & 1
E*	5 & 6	5 & 3	5 & 1

\*Jumper between terminals 2 & 5 for circuits H, G, M, R & S are specified in selection 4. External jumper between terminals 2 & 4 for circuit E are provided by customer. Circuit E may be used for SP OFF-ON-ON circuit.

**3 RATING 4**

1	.4VA @ 28VDC Resistive
B	15A 24V
C	20A 18V
D	20A 12V
E	20A 14V, 10A 14VT (circuit 1, 4, A & D only)
F	10A 14V, 6A 14VT (circuit G only)
M	.4VA/20A 12V
N	.4VA/15A 24V

**4 TERMINATION / BASE STYLE**

8 term	10 Term	Termination	Jumper
1	2	.250 TAB (QC) no barriers	No
A	B	.250 TAB (QC) with barriers	No
J	K	.250 TAB (QC) no barriers	Yes T2 to 5
3	5	Solder Lug no barriers	No
C	D	Solder Lug	No
5	6	Wire Leads no barriers	No
E	F	Wire Leads	No

Note: Codes J & K for circuits H, G & M.

**5 ILLUMINATION & SWITCH SEALING**

Lamp #1: above terminals 1 & 4 end of switch.; Lamp #2 above terminals 3 & 6 end of switch. Positive (+) and negative (-) symbols apply to LED lamps only

Sealed	Unsealed	Lamps	Illumination Type	Lamp wired to Terminals
	0	NONE	-	-
A	1	1	INDEPENDENT	8 (+) 7 (-)
B	2	1	DOWN	3 (+) 7 (-)
C	3	2	UP	3 (+) 7 (-)
D	4	1	DOWN	3 (+) 7 (-)
E	5	2	DOWN	1 (+) 7 (-)
F	6	1	UP	1 (+) 7 (-)
G	7	2	UP	3 (+) 7 (-)
H	Z	2	INDEPENDENT	8 (+) 7 (-)
U	Y	1	INDEPENDENT	8 (+) 7 (-)
		2	INDEPENDENT	10 (+) 9 (-)
<b>SINGLE POLE SWITCHES ONLY</b>				
J	8	1	DOWN	3 (+) 8 (-)
K	W	2	INDEPENDENT	6 (+) 7 (-)
		1	INDEPENDENT	8 (+) 7 (-)
		2	INDEPENDENT	6 (+) 7 (-)
<b>DOUBLE POLE SWITCHES ONLY</b>				
L	9	1	DOWN	3 (+) 6 (-)
M	R	1	UP	3 (+) 6 (-)
N	T	1	DOWN	3 (+) 6 (-)
		2	DOWN	1 (+) 4 (-)
P	V	1	UP	1 (+) 4 (-)
		2	UP	3 (+) 6 (-)

**6,7 LAMP (same coding for both selections)**

Selection 6: above terminals 1 & 4; Selection 7: above terminals 3 & 6  
 No lamp 0  
 Neon 1 125VAC 2 250VAC  
 Incandescent 4 3V 5 6V 6 12V superbright Green 7 18V superbright Red 8 24V superbright Red  
 LED\*  
 2VDC A Red L Amber F superbright Green  
 6VDC B M N H R  
 12VDC C P J S  
 24VDC D T V  
 \* Consult factory for "daylight bright" LED options. Typical current draw for LED is 20ma.

**8 FLUSH BRACKET COLOR 1, PANEL SEAL**

No Seal	Black B	White W	Gray G
One Seal	C	Y	H

**9 ACTUATOR**

0 No Actuator  
 Z Contura VII

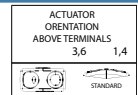

**10 LENS**

Lens color for LEDs must be clear, white, or match color of LED. Green or blue lenses are not recommended with Neon lamps.

0 - No Actuator	Z - No Lens	White	Amber	Green	Red	Blue	Lens style & location
6	B	G	M	T			
7	C	H	N	U			
8	D	J	P	V			
9	E	K	R	W			
A	F	L	S	Y			
1	2	3	4	5			

**11 ACTUATOR COLOR/THUMB PRINT COLOR 1**

O N/A - No Actuator C Black/Black  
 H Grey/Black S Red/Black  
 Y White/Black

**14 ACTUATOR LENS OR BODY LEGENDS 2**

11 ON	12 OFF	13 I	14 O
OFF	ON	O	I
15 O O	16 O O	17 O I	18 I O
F N	N F	F	

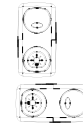

For additional legend options & codes, visit us at [www.carlingtech.com](http://www.carlingtech.com).

**13 LEGEND ORIENTATION**

0 No legend (used with codes 11-18 in selection 12)  
 1 Orientation 1  
 2 Orientation 2  
 3 Orientation 3  
 4 Orientation 4

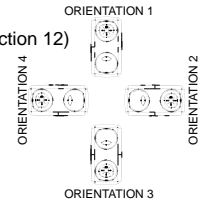
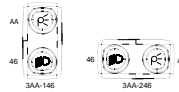

**14 ACTUATOR LENS LEGEND**

00 No legend this location / no actuator (used with codes 11-18 in selection 12) Selection 14 required when switch requires two legends. If the two legends consist of one lens and one body legend, lens legend must be specified in selection 12; body legend specified in selection 14. For legend options & codes, visit us at [www.carlingtech.com](http://www.carlingtech.com).

**Notes:**

- Consult factory to verify horsepower rating for your particular circuit choice.
- 1 Custom colors are available. Consult factory.
- 2 White imprinting is standard on black actuators. Black imprinting is standard on white, red and gray actuators. Custom colors are available, consult factory.
- 3 Additional ratings available. See V-Series Switch Accessories page.
- 4 Legends available for lighted oval lens version only

V	1	D	A	B	6	0	1	-	6	P	Z	00	-	0	00
1 Series	2 Circuit	3 Rating	4 Termination	5 Illumination	6 Lamp	7 Lamp	8 Bracket	9 Actuator	10 Lens	11 Lens	12 Legend	13 Legend Orientation	14 Actuator Lens Legend		

**1 SERIES**

V

**2 CIRCUIT**

Terminal Connections as viewed from bottom of switch: ( ) - momentary  
 SP - single pole - uses terminals 1, 2 & 3.  
 DP - double pole uses terminals 1, 2, 3, 4, 5 & 6.  
 Terminals 7, 8, 9 & 10 for lamp circuit only.

Position:	1	2	3
SP DP	2 & 3, 5 & 6	Connected Terminals	1 & 2, 4 & 5
1	(ON)	NON	OFF
2	(ON)	NON	OFF
3	(ON)	NON	OFF
4	(ON)	NON	OFF
5	(ON)	NON	OFF
6	(ON)	NON	OFF
7	(ON)	OFF	(ON)
8	(ON)	OFF	(ON)

**SPECIAL CIRCUITS**

	2 & 3	2 & 3, 5 & 4	5 & 4
H*	2 & 3	2 & 3, 5 & 4	5 & 4
G*	(2 & 3, 5 & 6)	2 & 3, 5 & 4	OFF
M*	(2 & 3, 5 & 6)	2 & 3, 5 & 4	1 & 2
R*	(2 & 3, 5 & 6)	2 & 3, 5 & 4	OFF
E*	5 & 6	5 & 4	2 & 1

\*Jumper between terminals 2 & 5 for circuits H, G, M, R & S are specified in selection 4. External jumper between terminals 2 & 4 for circuit E are provided by customer. Circuit E may be used for SP OFF-ON-ON circuit.

**3 RATING 4**

1	.4VA @ 28VDC Resistive
B	15A 24V
C	20A 18V
D	20A 12V
E	20A 14V, 10A 14VT (circuit 1, 4, A & D only)
F	10A 14V, 6A 14VT (circuit G only)
M	.4VA/20A 12V
N	.4VA/15A 24V

**4 TERMINATION / BASE STYLE**

8 term	10 Term	Termination	Jumper
1	2	.250 TAB (QC) no barriers	No
A	B	.250 TAB (QC) with barriers	No
J	K	.250 TAB (QC) no barriers	Yes T2 to 5
3	5	Solder Lug no barriers	No
C	D	Solder Lug	No
5	6	Wire Leads no barriers	No
E	F	Wire Leads	No

Note: Codes J & K for circuits H, G & M.

**5 ILLUMINATION & SWITCH SEALING**

Lamp #1: above terminals 1 & 4 end of switch.; Lamp #2 above terminals 3 & 6 end of switch. Positive (+) and negative (-) symbols apply to LED lamps only

Sealed	Unsealed	Lamps	Illumination Type	Lamp wired to Terminals
S	0	NONE	-	-
A	1	1	INDEPENDENT	8 (+) 7 (-)
B	2	1	DOWN	3 (+) 7 (-)
C	3	1	UP	3 (+) 7 (-)
D	4	1	DOWN	3 (+) 7 (-)
E	5	1	UP	1 (+) 7 (-)
F	6	1	UP	3 (+) 7 (-)
G	7	1	INDEPENDENT	8 (+) 7 (-)
H	Z	2	UP	3 (+) 7 (-)
U	Y	1	INDEPENDENT	8 (+) 7 (-)
		2	INDEPENDENT	10 (+) 9 (-)
<b>SINGLE POLE SWITCHES ONLY</b>				
J	8	1	DOWN	3 (+) 8 (-)
K	W	1	INDEPENDENT	6 (+) 7 (-)
		2	INDEPENDENT	8 (+) 7 (-)
		2	INDEPENDENT	6 (+) 7 (-)
<b>DOUBLE POLE SWITCHES ONLY</b>				
L	9	1	DOWN	3 (+) 6 (-)
M	R	1	UP	3 (+) 6 (-)
N	T	1	DOWN	3 (+) 6 (-)
		2	DOWN	1 (+) 4 (-)
P	V	1	UP	1 (+) 4 (-)
		2	UP	3 (+) 6 (-)

**6,7 LAMP (same coding for both selections)**

Selection 6: above terminals 1 & 4; Selection 7: above terminals 3 & 6

No lamp	0	1 125VAC	2 250VAC	6 12V superbright	7 18V superbright	8 24V superbright
Neon	1	4 3V	5 6V	6 12V superbright	7 18V superbright	8 24V superbright
Incandescent LED*	1	Red	Amber	Green	Red	Red
2VDC	A	L	F	R	S	T
6VDC	B	M	G	V	W	X
12VDC	C	N	H	Y	Z	
24VDC	D	P	J			

\* Consult factory for "daylight bright" LED options. Typical current draw for LED is 20ma.

**8 BRACKET COLOR 1, PANEL SEAL (EXTERNAL FOAM GASKET)**

X & XI with Flush Bracket X, XI, XII with Raised Bracket

# of gaskets	0	1	2	0	1
Black	B	C	D	1	4
White	W	Y	Z	2	5
Gray	G	H	J	3	6

**9 ACTUATOR**

No Actuator	0	Black	Gray	White	Red
Contura X	1	2	3	4	
Contura XI	6	7	8	9	
Contura XII	J	K	N	M	

Actuator orientation above terminals: 

**10 LENS - ABOVE LAMP #1 TERMINALS 1,4**

**11 LENS - ABOVE LAMP #2 TERMINALS 3,6**

0 - No Actuator Z - No Lens

	Clear	White	Amber	Green	Red	Blue	Lens Style
3	8	D	J	P	V	Bar	One piece Square
4	9	E	K	R	W	Two piece Square*	Two piece Square* (With clear top protective lens)
5	A	F	L	S	Y	Two piece Square*	Two piece Square* (With smoke top protective lens)
2	7	C	H	N	U	Two piece Square*	Two piece Square* (With white top protective lens)
1	6	B	G	M	T	Two piece Square*	Two piece Square* (With white top protective lens)

\* All bottom lenses are molded of opaque material. Consult factory for other lens colors. Lens color for LEDs must be clear, white, or match color of LED. Green or blue lenses are not recommended with Neon lamps.

**12 ACTUATOR LENS OR BODY LEGEND 2**

00 - No Legend this location/No actuator

11 ON	12 OFF	13 I	14 O
OFF	ON	O	I
15 O O	16 O O	17 O I	18 I O
F N	N F	F	
21 OFF	22 ON	23 O	24 I
F	N		
25 O	26 O	27 O	28 I
F	N		

For additional legend options & codes, visit us at [www.carlingtech.com](http://www.carlingtech.com).

**13 LEGEND ORIENTATION 3**

0 No legend (used with codes 11-18 in selection 12)

1 Orientation 1

2 Orientation 2

3 Orientation 3

4 Orientation 4



**14 ACTUATOR LENS LEGEND**

00 No legend this location / no actuator (used with codes 11-18 in selection 12) Selection 14 required when switch requires two legends. If the two legends consist of one lens and one body legend, lens legend must be specified in selection 12; body legend specified in selection 14. For legend options & codes, visit us at [www.carlingtech.com](http://www.carlingtech.com).

**Notes:**

- Consult factory to verify horsepower rating for your particular circuit choice.
- 1 Custom colors are available. Consult factory.
- 2 White imprinting is standard on black actuators; Black imprinting is standard on white, red & gray actuators. Custom colors are available, consult factory.
- 3 With 2 square lenses, use selection 12 for lens above lamp 1, & selection 14 for lens above lamp 2.
- 4 Additional ratings available. See V-Series Switch Accessories page.
- 5 Not available with Contura XI rockers.

**V 1 D A S W 0 1 - 1 P B 00 - 0**

1 Series    2 Circuit    3 Rating    4 Termination    5 Illumination    6 Lock    7 Lamp    8 Bracket    9 Actuator    10 Lens    11 Function    12 Legend    13 Legend Orientation

**1 SERIES**  
V

**2 CIRCUIT**  
Terminal Connections as viewed ( ) - momentary from bottom of switch: SP - single pole - uses terminals 1, 2 & 3. 8 terminal 10 terminal DP - double pole uses terminals 1, 2, 3, 4, 5 & 6. Terminals 7, 8, 9 & 10 for lamp circuit only.

8 - 7	8 - 7		
1 - 4	1 - 4		
2 - 5	2 - 5		
3 - 6	3 - 6		
	10 - 9		

**Position:**

SP	DP	2 & 3, 5 & 6	Connected Terminals	1 & 2, 4 & 5
1 A		ON	NONE	OFF
4 D		ON	NONE	ON
6 J		ON	OFF	ON
9 N		OFF	NONE	ON

**SPECIAL CIRCUITS**

H*	2 & 3	2 & 3, 5 & 4	5 & 4
G*	2 & 3, 5 & 6	2 & 3	OFF
S*	2 & 3, 5 & 6	2 & 3	1 & 2
E*	5 & 6	5 & 3	5 & 1

\*Jumper between terminals 2 & 5 for circuits H,G,M,R & S are specified in selection 4. External jumper between terminals 2 & 4 for circuit E are provided by customer. Circuit E may be used for SP OFF-ON-ON circuit.

**3 RATING 4**

1	.4VA @ 28VDC Resistive
B	15A 24V
C	20A 18V
D	20A 12V
E	20A 14V, 10A 14VT (circuit 1, 4, A & D only)
F	10A 14V, 6A 14VT (circuit G only)
M	.4VA/20A 12V
N	.4VA/15A 24V

**4 TERMINATION / BASE STYLE**

8 term	10 Term	Termination	Jumper
1	2	.250 TAB (QC) no barriers	No
A	B	.250 TAB (QC) with barriers	No
J	K	.250 TAB (QC) no barriers	Yes T2 to 5
3	5	Solder Lug no barriers	No
C	D	Solder Lug	No
E	6	Wire Leads no barriers	No
S	F	Wire Leads	No

Note: Codes J & K for circuits H, G & M.

**5 ILLUMINATION & SWITCH SEALING**  
Lamp #1: above terminals 1 & 4 end of switch.; Lamp #2 above terminals 3 & 6 end of switch. Positive (+) and negative (-) symbols apply to LED lamps only

Sealed	Unsealed	Lamps	Illumination Type	Lamp wired to Terminals
S	0	NONE	-	-
C	3	2	UP	3 (+) 7 (-)
H	Z	2	INDEPENDENT	8 (+) 7 (-)

**DOUBLE POLE SWITCHES ONLY**

M	R	1	UP	3 (+) 6 (-)
---	---	---	----	-------------

**6 LOCK**  
Lock above terminals 1 & 4 end of switch.  
W Lock

Notes:  
Consult factory to verify horsepower rating for your particular circuit choice.  
1 Custom colors are available. Consult factory.  
2 White imprinting is standard on black actuators; Black imprinting is standard on white, red and gray actuators; Custom colors are available, consult factory.  
3 Located over T1-4 end of switch.  
4 Additional ratings available. See V-Series Switch Accessories page.  
5 Located over T3-6 end of switch.

**6,7 LAMP (same coding for both selections)**  
Selection 6: above terminals 1 & 4; Selection 7: above terminals 3 & 6

No lamp	0				
Neon	1 125VAC	2 250VAC			
Incandescent	4 3V	5 6V	6 12V superbright	7 18V superbright	8 24V superbright
LED*					
2VDC	Red	Amber	Green	Red	
6VDC	A	L	F	R	
12VDC	B	M	G	S	
24VDC	C	N	H	T	
	D	P	J	V	

\* Consult factory for "daylight bright" LED options. Typical current draw for LED is 20ma.

**8 FLUSH BRACKET COLOR 1, PANEL SEAL**

	Black	White	Gray
No Gasket	1	2	3
One Gasket	4	5	6

**9 HARD SURFACE ACTUATOR**

Contura X	Black	Grey	Red	White
	1	2	3	4

Actuator orientation above terminals: 3,6    1,4

**10 LENS - ABOVE LAMP #2 TERMINALS 5**  
Z - No Lens

Clear	White	Amber	Green	Red	Blue	Lens Style
3	8	D	J	P	V	Bar
4	9	E	K	R	W	One piece Square
5	A	F	L	S	Y	Two piece Square* (with clear top protective lens)
2	7	C	H	N	U	Two piece Square* (with smoke top protective lens)
1	6	B	G	M	T	Two piece Square* (with white top protective lens)

\* All bottom lenses are molded of opaque material. Consult factory for other lens colors.  
Lens color for LEDs must be clear, white, or match color of LED.  
Green or blue lenses are not recommended with Neon lamps.

**11 ACTUATOR LOCK FUNCTION AND COLOR 3**

Lock Color	Up	Down	Up & Down
Match Actuator	A	H	R
Black	B	J	S
White	C	K	T
Red	D	L	V
Gray	E	M	W
Safety Orange	F	N	Y

**12 ACTUATOR LENS OR BODY LEGEND 2**  
00 - No Legend

21	22	23	24
OFF	ON	O	I
25	26	27	28
O	O	O	I
F	N		
F			

For additional legend options & codes, visit us at [www.carlingtech.com](http://www.carlingtech.com).

**13 LEGEND ORIENTATION 3**

0	No legend (used with codes 11-18 in selection 12)
1	Orientation 1
2	Orientation 2
3	Orientation 3
4	Orientation 4

13DMC-1    1PM4F-1    4F    45    18K4S-2

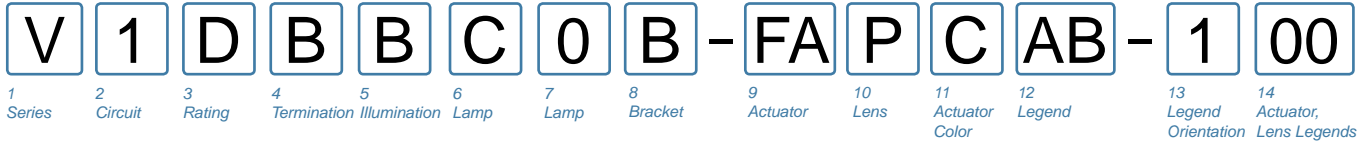

**1 SERIES**  
V

**2 CIRCUIT**  
Terminal Connections as viewed ( ) - momentary from bottom of switch; SP - single pole - uses terminals 1, 2 & 3. 8 terminal 10 terminal DP - double pole uses terminals 1, 2, 3, 4, 5 & 6. 8 - -7 8 - -7 Terminals 7, 8, 9 & 10 for lamp circuit only.  
1 - -4 1 - -4  
2 - -5 2 - -5  
3 - -6 3 - -6  
10 - -9

Position:	1	2	3
SP DP	2 & 3, 5 & 6	Connected Terminals	1 & 2, 4 & 5
1 A	ON	NONE	OFF
2 B	(ON)	NONE	OFF
3 C	ON	NONE	(OFF)
4 D	ON	NONE	ON
5 F	ON	NONE	(ON)
6 J	ON	OFF	ON
7 K	ON	OFF	(ON)
8 L	(ON)	OFF	(ON)

**SPECIAL CIRCUITS**  
H\* 2 & 3 2 & 3, 5 & 6 5 & 4  
G\* 2 & 3, 5 & 6 2 & 3 OFF  
M\* (2 & 3, 5 & 6) 2 & 3 OFF  
R\* (2 & 3, 5 & 6) 2 & 3 2 & 1  
E\* 5 & 6 5 & 3 5 & 1  
S\* 2 & 3, 5 & 6 2 & 3 1 & 2  
\*Jumper between terminals 2 & 5 for circuits H, G, M, R & S are specified in selection 4. External jumper between terminals 2 & 4 for circuit E are provided by customer. Circuit E may be used for SP OFF-ON-ON circuit.

**3 RATING 3**  
1 .4VA @ 28VDC Resistive  
B 15A 24V  
C 20A 18V  
D 20A 12V  
E 20A 14V, 10A 14VT (circuit 1, 4, A & D only)  
F 10A 14V, 6A 14VT (circuit G only)

**4 TERMINATION / BASE STYLE**  
8 term 10 Term Termination Jumper  
1 2 .250 TAB (QC) no barriers No  
A B .250 TAB (QC) with barriers No  
J K .250 TAB (QC) no barriers Yes T2 to 5  
3 4 Solder Lug no barriers No  
C D Solder Lug No  
5 6 Wire Leads no barriers No  
E F Wire Leads No  
Note: Codes J & K for circuits H, G & M.

**5 ILLUMINATION**  
Lamp #1: above terminals 1 & 4 end of switch.; Lamp #2 above terminals 3 & 6 end of switch. Positive (+) and negative (-) symbols apply to LED lamps only

S	Lamps	Illumination Type	Lamp wired to Terminals
A	1	INDEPENDENT	8 (+) 7 (-)
B	1	DOWN	3 (+) 7 (-)
C	2	UP	3 (+) 7 (-)
D	1	DOWN	3 (+) 7 (-)
E	2	DOWN	1 (+) 7 (-)
F	1	UP	1 (+) 7 (-)
G	2	UP	3 (+) 7 (-)
H	1	INDEPENDENT	8 (+) 7 (-)
I	2	UP	3 (+) 6 (-)
J	1	INDEPENDENT	8 (+) 7 (-)
K	2	UP	3 (+) 6 (-)
L	1	DOWN	3 (+) 6 (-)
M	1	UP	3 (+) 6 (-)
N	1	DOWN	3 (+) 6 (-)
P	2	DOWN	1 (+) 4 (-)
U	1	UP	1 (+) 4 (-)
V	2	UP	3 (+) 6 (-)
W	1	INDEPENDENT	8 (+) 7 (-)
X	2	INDEPENDENT	10 (+) 9 (-)

**6 & 7 LAMP**  
No lamp 0  
Neon 1 125VAC 2 250VAC  
Incandescent 4 3V 5 6V  
LED\* 6 12V superbright Green  
7 18V superbright Red  
8 24V superbright Red  
2VDC A Red L Amber F superbright Green  
6VDC B M N H J  
12VDC C P  
24VDC D  
\* Consult factory for "daylight bright" LED options. Typical current draw for LED is 20ma.

**8 BRACKET COLOR & PANEL SEAL**  
Color No Gasket 1 Gasket 2 Gasket  
Black B C D  
Gray G H J  
White W Y Z

**9 ACTUATOR STYLE**  
0 No Actuator - Furnished separately  
FA Contura XIV  
FB Contura XIV - Laser Etched

**10 LENS COLOR / STYLE**  
0 - No Actuator Z - No Lens  
Clear White Amber Green Red Blue  
1 6 B G M T  
2 7 C H N U  
3 8 D J P V  
4 9 E K R W  
5 A F L S Y  
PAD Printed Laser-Etched  
Lens color for LEDs must be clear, white, or match color of LED. Green or blue lenses are not recommended with Neon lamps.

**11 ACTUATOR COLOR 1**  
0 N/A - No Actuator  
C Black  
S Red  
Y White

**12 ACTUATOR LENS or BODY LEGEND 2**  
00 - No Legend this location/No actuator  
11 ON 12 OFF 13 I 14 O  
OFF ON O I  
15 O O 16 O O 17 O I 18 I O  
F N N F  
F F

**13 LEGEND ORIENTATION**  
0 No legend  
1 Orientation 1  
2 Orientation 2  
3 Orientation 3  
4 Orientation 4

**14 ACTUATOR / LENS LEGEND**  
00 No legend this location / no actuator (used with codes 11-18 in selection 12) Selection 14 required when switch requires two legends. If the two legends consist of one lens and one body legend, lens legend must be specified in selection 12; body legend specified in selection 14.  
For legend options & codes, visit us at [www.carlingtech.com](http://www.carlingtech.com).

Notes:  
Consult factory to verify horsepower rating for your particular circuit choice.  
1 Custom colors are available. Consult factory.  
2 White imprinting is standard on black actuators; Black imprinting is standard on white, red and gray actuators.  
3 Additional ratings available. See V-Series Switch Accessories page.

Dimensional Specifications: in. [mm]

**CONTURA II**

SHOWN WITH SQUARE LENS

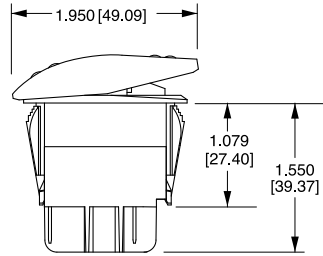
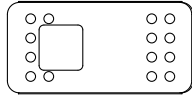

**8 TERMINAL BASE W/BARRIERS**

**CONTURA III**

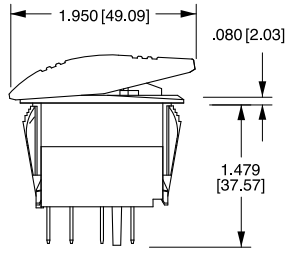
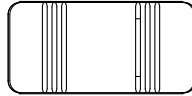

**8 TERMINAL BASE W/O BARRIERS**

**CONTURA IV**

SHOWN WITH BAR LENS

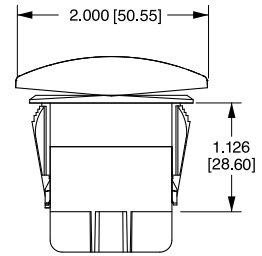
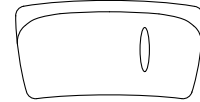

**10 TERMINAL BASE W/BARRIERS**

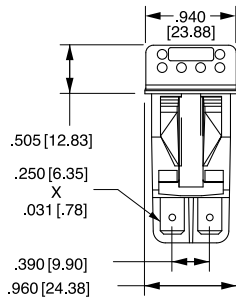

**8 TERMINAL BASE W/BARRIERS**

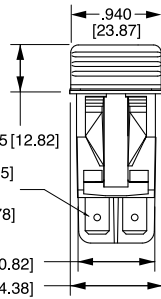

**10 TERMINAL BASE W/BARRIERS**

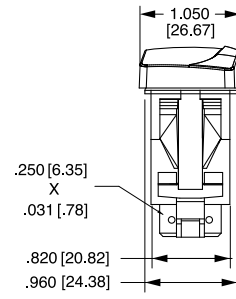

**10 TERMINAL BASE W/O BARRIERS**

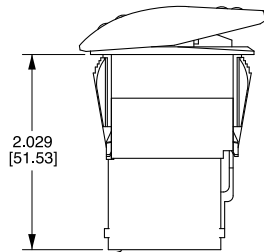

**SWITCH SHOWN WITH VCH CONNECTOR 8 TERMINAL**

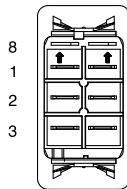

**BOTTOM VIEW TERMINAL ARRANGEMENT 8 TERMINAL BASE**

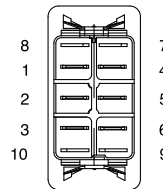

**BOTTOM VIEW TERMINAL ARRANGEMENT 10 TERMINAL BASE**

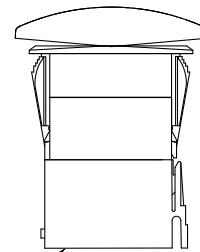

**SWITCH SHOWN WITH VC1 CONNECTOR 10 TERMINAL**

Dimensional Specifications: in. [mm]

**CONTURA V**

SHOWN WITH  
BAR LENS

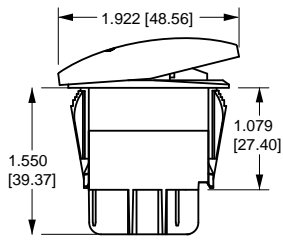
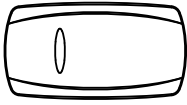

**8 TERMINAL BASE  
W/BARRIERS**

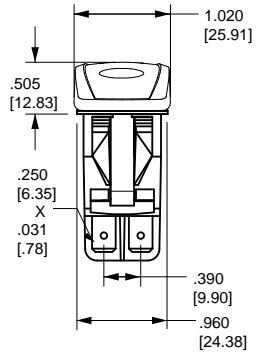

**8 TERMINAL BASE  
W/BARRIERS**

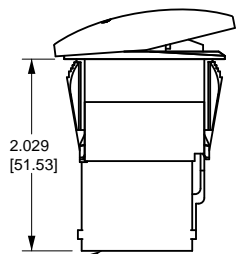

SWITCH SHOWN WITH  
VCH CONNECTOR 8  
TERMINAL

**CONTURA V**

SHOWN WITH  
LOW PROFILE LOCK

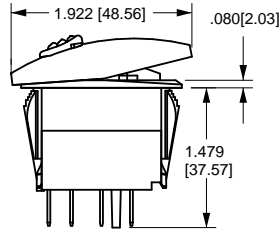
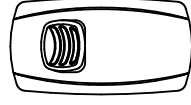

**8 TERMINAL BASE  
W/O BARRIERS**

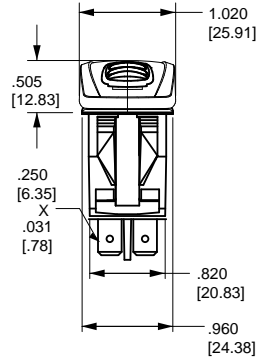

**8 TERMINAL BASE  
W/O BARRIERS**

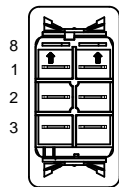

**BOTTOM VIEW  
TERMINAL  
ARRANGEMENT  
8 TERMINAL BASE**

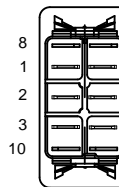

**BOTTOM VIEW  
TERMINAL  
ARRANGEMENT  
10 TERMINAL BASE**

**CONTURA VI**

SHOWN WITH OVAL  
LENS

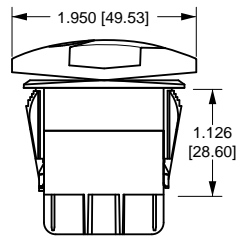
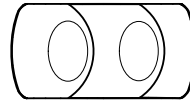

**10 TERMINAL BASE  
W/BARRIER AND  
LAMP TERMINAL**

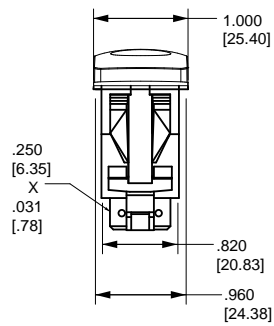

**10 TERMINAL BASE  
W/O BARRIERS**

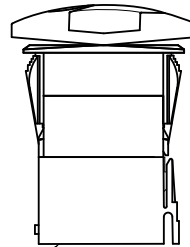

SWITCH SHOWN WITH  
VC1 CONNECTOR 10  
TERMINAL

**CONTURA VII**

SHOWN WITH LARGE LENS  
AND BAR LENS

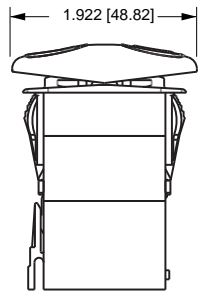
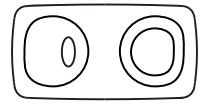

**10 TERMINAL BASE  
W/O BARRIERS**

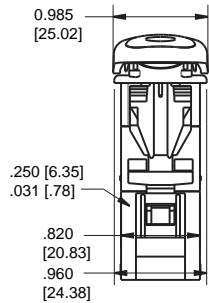

**10 TERMINAL BASE  
W/O BARRIERS**

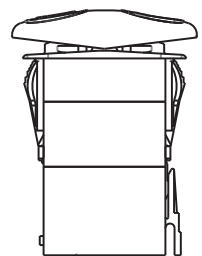

SWITCH SHOWN WITH  
VC1 CONNECTOR 10  
TERMINAL

Dimensional Specifications: in. [mm]

**CONTURA X**  
SHOWN WITH RAISED BRACKET

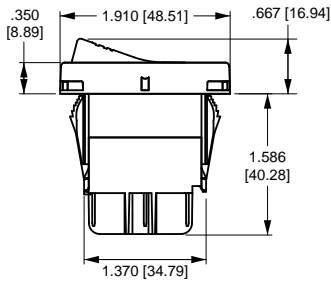
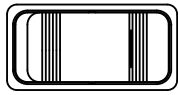

8 TERMINAL BASE  
W/BARRIERS

**CONTURA XI**  
SHOWN WITH RAISED  
BRACKET AND TWO SQUARE  
LENSES

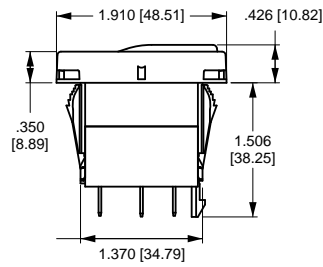
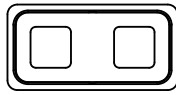

10 TERMINAL BASE  
W/O BARRIERS

**CONTURA XII**  
SHOWN WITH PADDLE  
ACTUATOR

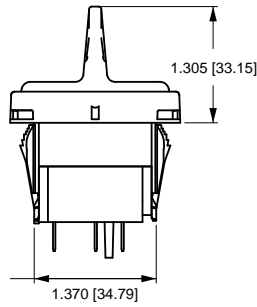
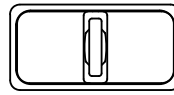

8 TERMINAL BASE  
W/O BARRIERS

**CONTURA XIV**  
SHOWN WITH LARGE LENS

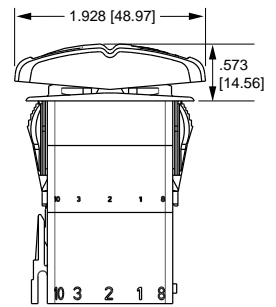
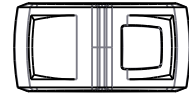

10 TERMINAL BASE  
W/O BARRIERS

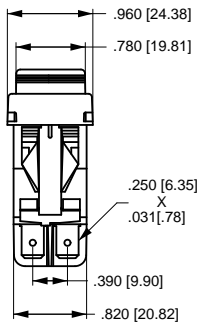

8 TERMINAL BASE  
W/BARRIERS

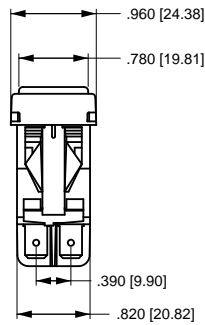

10 TERMINAL BASE  
W/BARRIERS

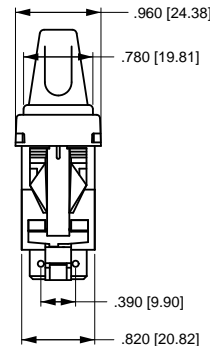

10 TERMINAL  
BASE  
W/O BARRIERS

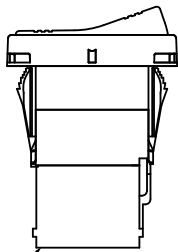
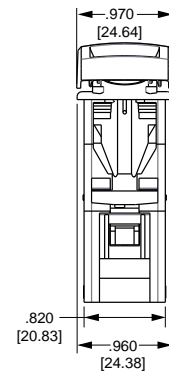

SWITCH SHOWN WITH  
VCH CONNECTOR  
8 TERMINAL

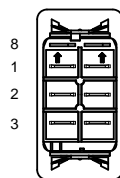

BOTTOM VIEW  
TERMINAL  
ARRANGEMENT  
8 TERMINAL BASE

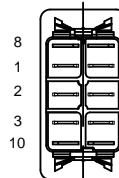

BOTTOM VIEW  
TERMINAL  
ARRANGEMENT  
10 TERMINAL BASE

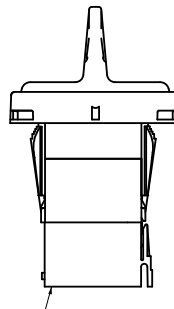

SWITCHES SHOWN WITH  
VC1 CONNECTOR  
10 TERMINAL

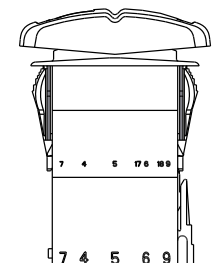

Circuit Diagrams:

CIRCUIT	CIRCUIT DIAGRAM
1	
2	
3	
4	
5	
6	
7	
8	

CIRCUIT	CIRCUIT DIAGRAM
A	
B	
C	
D	
E	
F	
G	
H	

CIRCUIT	CIRCUIT DIAGRAM
J	
K	
L	
M	
R	
S	

SYMBOL LEGEND	
SYM.	DEFINITION
	DESIGNATES TERMINALS AND CONTACTS
	DESIGNATES LAMP LOCATION
	DESIGNATES MAINTAINED CIRCUITS
	DESIGNATES OTHER POSITION
	DESIGNATES MOMENTARY CIRCUITS
	DESIGNATES TWO POSITION CONNECTION
	DESIGNATES EXTERNAL JUMPER PROVIDED BY CUSTOMER



### Lamp Circuit Diagrams:

LAMP CIRCUIT	CIRCUIT DIAGRAM	LAMP CIRCUIT	CIRCUIT DIAGRAM	LAMP CIRCUIT	CIRCUIT DIAGRAM	LAMP CIRCUIT	CIRCUIT DIAGRAM
A/1		F/6		L/9		SPECIAL #1	
B/2		G/7		M/R		SPECIAL #3	
C/3		H/Z		N/T		SPECIAL #4	
D/4		J/8		P/V			
E/5		K/W		U/Y			

### Hazard Warning Circuit Diagrams:

CIRCUIT	CIRCUIT DIAGRAM	CIRCUIT	CIRCUIT DIAGRAM	CIRCUIT	CIRCUIT DIAGRAM
J1		J5		JA	
J2				JJ	
J3				JK	
J4					

NOTE:  
J circuits are available for all non-locking V-Series styles. Consult factory for p/n details.

SYMBOL LEGEND	
SYM.	DEFINITION
○	DESIGNATES TERMINALS AND CONTACTS
⊙	DESIGNATES LAMP LOCATION

# Rotary

## V-Series

### CONTURA ROTARY SWITCHES

The V-Series Contura Rotary Switch was designed for maximum performance and reliability leveraging the features of the widely popular V-series Contura Rocker Switches. Available in maintained and momentary circuit options, the V-Series Rotary features a sturdy knob construction, up to three separate LEDs, and fits in an industry standard panel opening.

Internally, the V-Series Contura Rotary uses a patented mechanism that translates rotary to linear motion. This allows for common switch functionality and terminal connections with the V-Series rocker version and requires no harness change. A secondary CAM, which helps drive the mechanism, provides definitive detent positions and prevents the switch from stopping between positions, while improving tactile feel.

The V-Series Rotary also features an innovative PC board that supports the LED and surface mount resistors; and IP67 sealing protection above panel by utilizing LED and actuator stem seals. Together, these features make the V-Series Contura Rotary switch the best choice available in the market today.

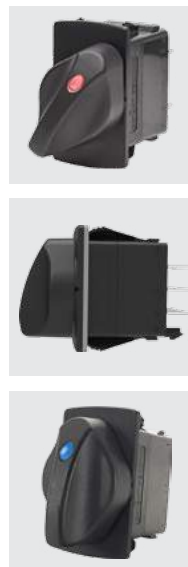

#### Resources:

*Download 3D CAD Files*



*Watch Product Video*



#### Product Highlights:

- ♦ Accommodates up to three separate LEDs
- ♦ Patented mechanism translates rotary into linear motion
- ♦ Secondary CAM for definitive detent positions
- ♦ PC Board supports LED and surface mount resistors
- ♦ IP67 sealing protection above panel
- ♦ Common terminal & circuit functionality with V-Series Rocker switches, with no harness change required

# V-Series Rotary Switch

## DESIGN FEATURES

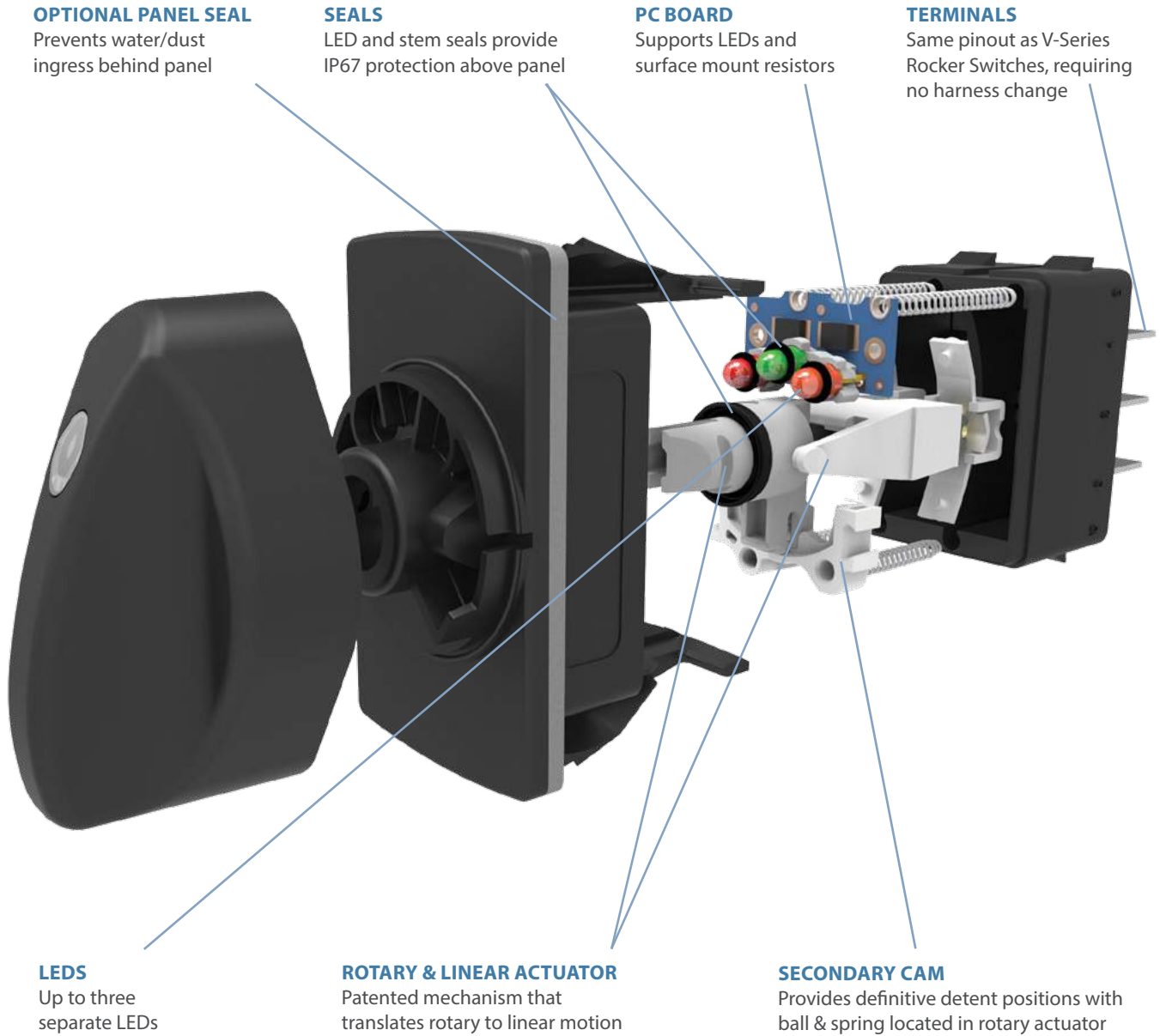

## Electrical

Rating

Circuit	Voltage	Max Current Resistive
2 Position Maintain	12	20
2 Position Momentary	12	20
3 Position All	12	20
2 Position Maintain	24	15
2 Position Momentary	24	15
3 Position All	24	15

Dielectric Strength	1500 Volts RMS
Insulation Resistance	50 Megohms
Initial Contact Resistance	10 Milli Ohm max @ 4VDC
Life	50,000 Cycles Two Position 25,000 Cycles Two Position Momentary and All Three position
Terminals	0.250" (6.3mm) Quick Connect

## Physical

Function Circuits	Double Pole Single Throw, DPST Double Pole Double Throw, DPDT
Operation	Two and Three Position Maintained and Momentary
Knob Rotation	Two Position 60 Degrees Three Position 30 Degrees from Center
Illumination	LED; Red, Green, Amber, Yellow, White, Blue
Seals	LED O-ring(s) – Silicone, Bezel gasket – Neoprene, Knob seal - NBR
Flammability	Exceeds FVMSS 302 Requirements, Exterior Components, UL 94 V-2 or Better Interior Components, UL 94 HB or Better
Base	Polyester, PBT
Bracket	Nylon 66, PA
Knob	Polybutylene Terephthalate, PBT 6.5%GF
Lens	Polycarbonate, PC
Connector	Nylon 66, PA
Mounting	Front Panel Snap In, 1.450" (36.83mm) X 0.830" (21.08mm) Panel Thickness, 0.030" – 0.187" (0.76 – 4.75mm)

## Mechanical

Mechanical Life	100,000 Cycles Maintained Circuits 50,000 Cycles Momentary Circuits
Knob Impact	50 Gram weight dropped from a height of 18 inches on Top & Sides

## Environmental

Sealing	IP67, in accordance with IEC 60529, BS 5490, DIN 40050 & NFC 20 010. This rating applies to front panel components of the actual switch only, and signifies protection against dust and the prolonged effects of immersion under pressure.
Dust	Mil STD 810, Method 510.2 Air Velocity 300 Ft/Min Duration 16Hr
Corrosion	IEC 68-2-60 Mixed Flowing Gas (MFG) 14 Days
Chemical Splash	Gasoline, Diesel, Motor Oil, Brake Fluid, Ammonia, Armour All
Salt Spray	Mil STD 202G, Method 101, Test Condition A 96 Hr
Vibration Random	Mil STD 202G, Method 214 test Condition C 10G's RMS
Vibration Sinusoidal	Mil STD 202G, Method 204D, Test Condition A 0.06DA or 10G's 10-500Hz
Shock	MIL-STD 202G, Method 213B Test Condition K, 30G's
Handling Shock	1 Meter Drop onto Hard Surface
Thermal Shock	MIL-STD 202G, Method 107G Test Condition A -55 C to 85 C
Moisture Resistance	MIL-STD 202G, Method 106F 10, 25 C to 65 C Cycles 95% RH
Thermal Cycling	25 Cycles -40 C to 85 C
Ignition Protection	ISO 8846 with EC Directive 94/25/EC for Marine Products
UV Protection	300 hr Xenon Arc, 1.4W/m2 wavelength 420 nm
ESD	Human Static Discharge, +/- 15KV applied during normal operation Shipping/Handling, frequency range 200-2000 MHz applied voltage is +8KV to +15KV and -8KV to -15KV 3 discharge cycles

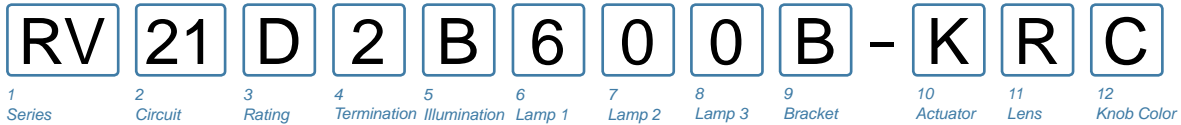

**1 SERIES**  
RV Rotary Contura

**2 CIRCUIT 1**  
Terminal Connections as viewed from bottom of switch: ( ) - momentary DP - double pole uses 1, 2, 3 and 4, 5, 6.

8 -	- 7		
1 -	- 4		
2 -	- 5		
3 -	- 6		
10 -	- 9		

Position:	1	2	3
DP	2 & 3, 5 & 6	Connected	Terminals 1 & 2, 4 & 5
21	ON	NONE	OFF
22	(ON)	NONE	OFF
23	ON	NONE	(OFF)
24	ON	NONE	ON
26	ON	OFF	ON
28	(ON)	OFF	(ON)

**SPECIAL CIRCUITS**

55	(ON)	OFF	ON
61	2 & 3, 5 & 6	2 & 3, 4 & 5	1 & 2, 4 & 5
62	2 & 3, 5 & 6	2 & 3	OFF
64	(2 & 3, 5 & 6)	2 & 3	OFF

**3 RATING**

1	.4VA 28VDC Resistive
B	15A 24V
D	20A 12V

**4 TERMINATION / BASE STYLE**

8 Term	10 Term	Termination	Jumper
1	2	.250 TAB (QC) - no barriers	No
A	B	.250 TAB (QC) - with barriers	No
J 4, 5	K 4, 5	.250 TAB (QC) - no barriers	Yes (T2 to T5)

- Notes:
- Switch circuit uses terminals 1,2,3,4,5 & 6. Terminals 7,8,9 & 10 are for lamp circuit only.
  - Jumper between terminals 2 & 5 for Circuits 61, 62, & 64 to be specified in the Termination & Jumper selection.
  - Circuit 61 may be used for SP, OFF-ON-ON circuit.
  - Base will not have terminal insulating barriers when connector and/or jumpers are used.
  - Code J,K are optional for circuits 62 and 64. Customer may provide externally wired jumper to connect terminals 2 and 5.
  - Lamp #1 located at top end of switch, above terminal 4.  
Lamp #2 located at top end of switch between terminals 1 & 4.  
Lamp #3 located at top end of switch, above terminal
  - Positive (+) and negative (-) symbols apply to L.E.D. lamps only.  
Mounting hole size is 1.450" (36.83mm) by 0.830" (21.08mm). To mount multiple switches in single panel cut-out order optional interlocking mounting panels.
  - Lens color for L.E.D.s must be clear, white, or match color of L.E.D.

**5 ILLUMINATION 6, 8**

Sealed	Lamps	when illuminated	Terminals
S	NONE		
A	# 1	Independent	8+ 7-
B	# 1	Dependent	3+ 7-
C	# 1	Independent	8+ 7-
D	& # 3	Independent	10+ 7-
E	# 1	Dependent	3+ 7-
F	& # 3	Dependent	1+ 7-
G	# 1	Independent	8+ 7-
H	# 2	Independent	8+ 7-
J	# 1	Independent	8+ 7-
K	# 2	Independent	10+ 7-
L	# 1	Dependent	3+ 7-
M	# 2	Independent	8+ 7-
N	# 3	Independent	10+ 7-
P	# 2	Independent	10+ 7-
R	# 3	Dependent	1+ 7-
T	# 3	Independent	8+ 7-
	# 3	Dependent	1+ 7-

**6, 7, 8 LAMP #1, 2 AND OR LAMP #3 6, 8**  
Selection 6: above terminal 7; Selection 8: above terminal 8

No lamp	0				
LED	Red	Amber	Green	Blue	White
12VDC	C	N	H	E	6
24VDC	D	P	J	K	8

**9 BRACKET COLOR & PANEL SEAL 7**

Color	No Gasket	1 Gasket	2 Gasket
Black	B	C	D
Gray	G	H	J
White	W	Y	Z

**10 ACTUATOR STYLE**

K Rotary Knob (Standard)

ACTUATOR ORIENTATION ABOVE TERMINALS

**11 LENS COLOR 8**

No Lens	Z				
Clear	White	Amber	Green	Red	Blue
4	9	E	K	R	W

**12 KNOB COLOR**

Black	Gray	Red	White
C	H	S	Y

Dimensional Specifications: in. [mm]

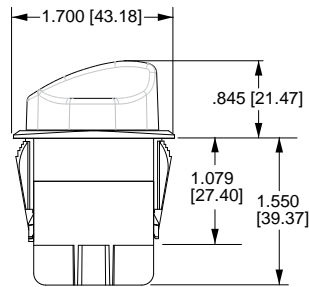
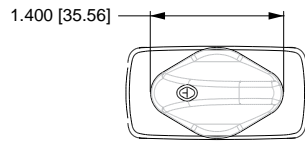

**10 TERMINAL BASE  
W/ BARRIERS**

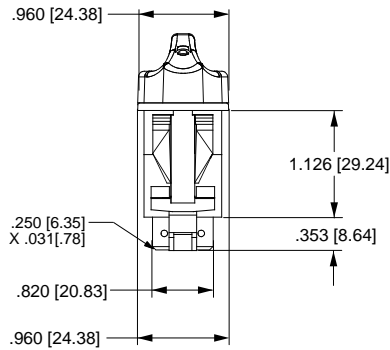

**10 TERMINAL BASE  
W/O BARRIERS**

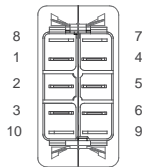

**BOTTOM VIEW  
TERMINAL ARRANGEMENT  
10 TERMINAL BASE**

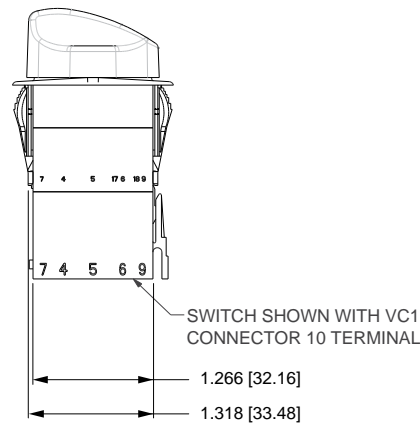

SWITCH SHOWN WITH VC1  
CONNECTOR 10 TERMINAL

Circuits Diagrams:

KNOB POSITIONS

KNOB POSITIONS

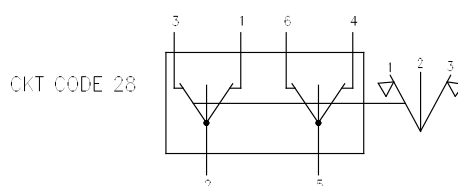
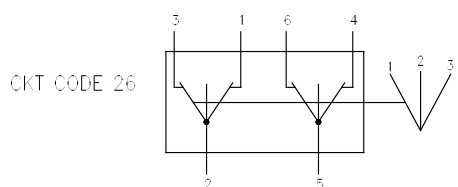
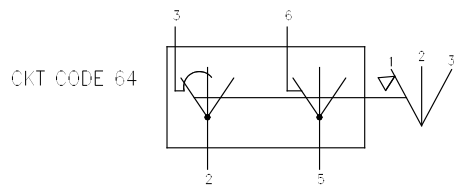
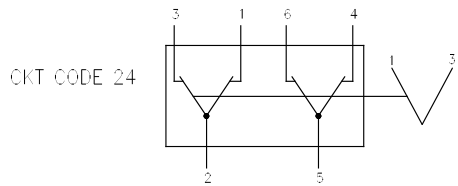
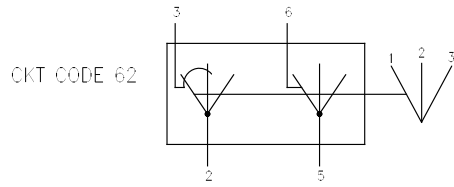
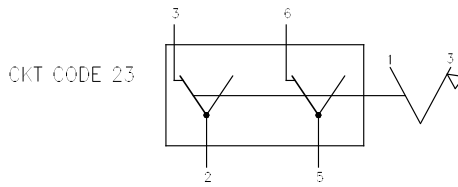
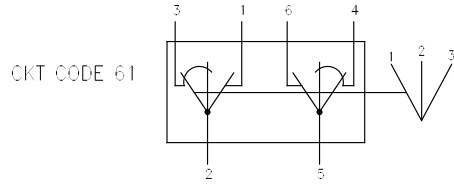
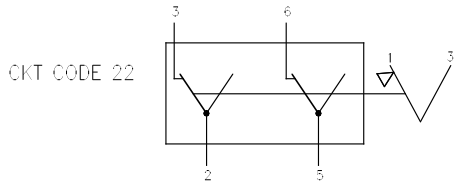
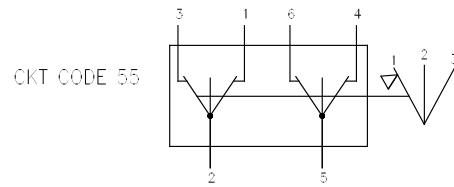
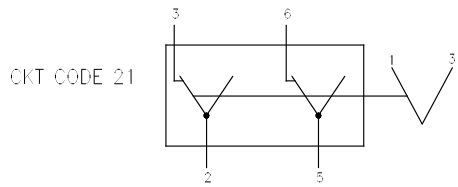

**LEGEND**

SYMBOL	DEFINITION
	TERMINAL LOCATION
	MAINTAINED CIRCUIT
	MOMENTARY CIRCUIT
	INTERNAL CONNECTION (JUMPER TERMINAL)
	2 POSITION CONNECTION
	2 POSITION CONNECTION
	2 POSITION
	3 POSITION

Lamp Circuit Diagrams:

LAMP CIRCUIT	CIRCUIT DIAGRAM
A	
B	
C	
D	
E	
F	
G	
H	
J	
K	

LAMP CIRCUIT	CIRCUIT DIAGRAM
L	
M	
N	
P	
R	
T	



# V-Charger

## V-SERIES DUAL PORT USB 2.0 CHARGERS

Carling Technologies USB V-Charger is designed to charge tablets, e-readers, mobile and gaming devices, digital cameras, as well as other compatible electronic devices.

Providing a total current of 3.15 amps, the V-Charger delivers fast charging times even in extreme temperatures from -40°C to +80°C. This innovative product safeguards its electronics with integrated over-current and thermal overload protection, as well as optional load dump circuitry, assuring prolonged safe and reliable operation. The center LED indicates charging is in progress. Snap-in mounting for an industry standard 1.450” x .830” panel cutout makes installation easy.

\*Additionally, the V-Charger’s double torsion spring-loaded access doors automatically close and provide effortless IP64 sealing protection with precision-fit silicone rubber seals.



### Resources:

*Download 3D CAD Files*



*Watch Product Video*



### Product Highlights:

- Dual USB Charging Ports
- 3.15 Amps for Faster Charging
- 10,000 Operating Cycles per Port
- IP64 Sealing Protection
- 12-24 V Operating Voltage
- Protection for Internal Components

# V-Charger

## DESIGN FEATURES

### DUAL USB 2.0 PORTS

Total current of 3.15 amps, facilitating faster charges

### SPRING LOADED DOORS

Stylish, wing-shaped double doors automatically close to cover and seal each port when not in use

### LED

Green LED brightens to indicate charging is in progress

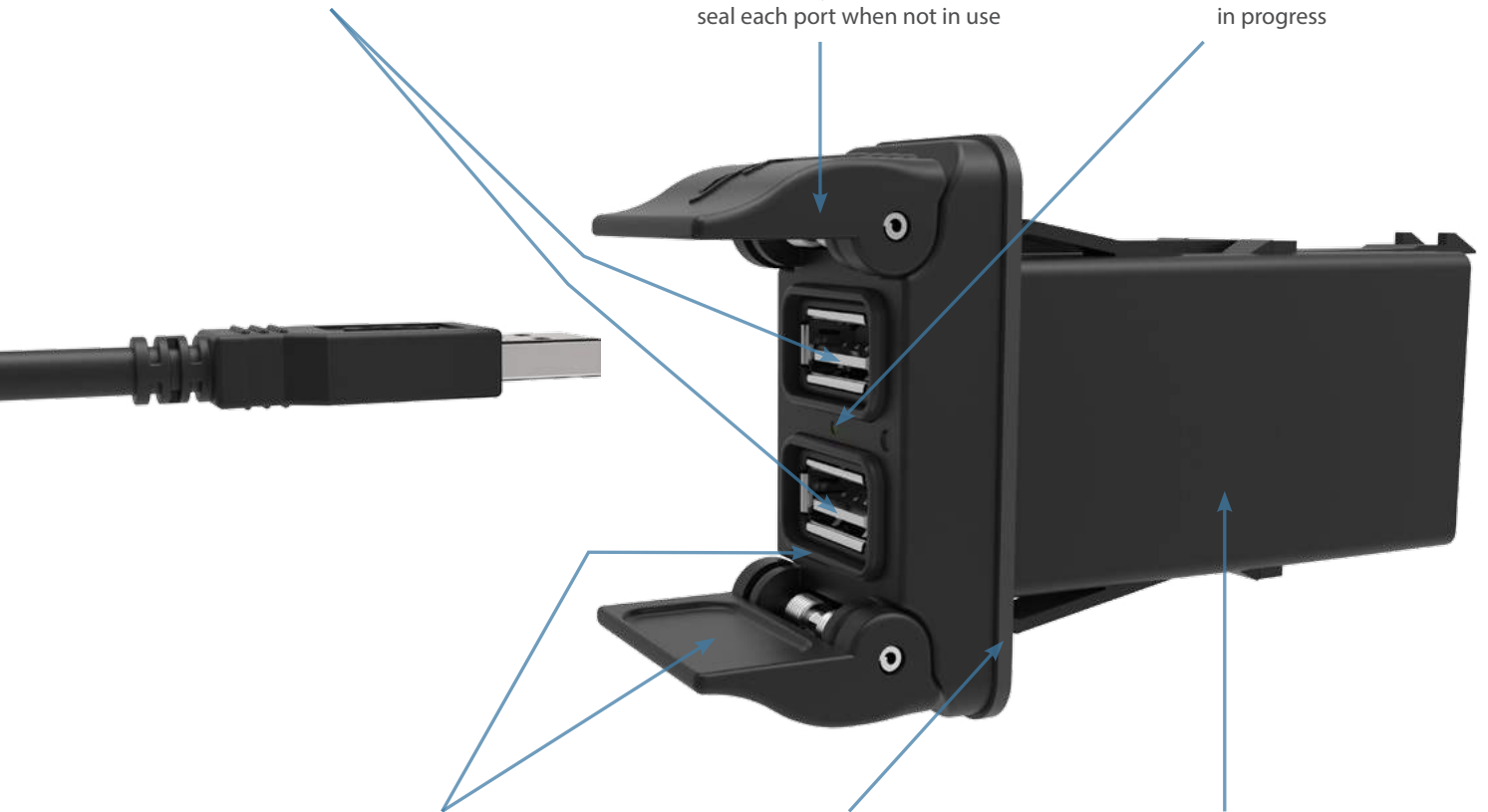

### SEALING PROTECTION

Silicone rubber seal perfectly mates with door indent to provide IP64 level of sealing protection

### PANEL SEAL

Prevents water ingress beneath panel to protect critical connections

### MOUNTING

Fits industry standard panel opening size of 1.450" x .830"

## Electrical

USB Type	2.0
Number of USB Ports	2
Operating Voltage	12V/24V DC power systems (9 to 29 VDC)
Output Voltage	5 VDC $\pm$ 5%
Max Output Current	3.15A DC Total
Current Draw (No Load)	12V: 0.8 mA, 24V: 1.9 mA
LED Indicator	Green LED brightens when charging is in progress.
Compatibility	Charges mobile devices including iPad, iPhone, iPod, HTC, Galaxy, Blackberry, MP3 Players, Digital Cameras and PDA's
Life	10,000 operating cycles per port minimum
Terminals	Copper/silver plating 1/4" (6.3 mm) Quick Connect terminations
Reverse Polarity	Operational with correct polarity after reverse polarity exposure
ESD	15kV air, 8 kV touch
Overcurrent Protection	Short Circuit
Thermal Overload Protection	Operation will cease if internal temperature reaches 125°C. Charging will resume after sufficient heat loss

## Physical

Panel Opening	1.450" x .830"
Panel Thickness	.030 - .156 inches
Panel Mounting Method	Front Panel Insertion
Seals	Silicone and Poron
Depth Behind Panel	See Figures 1 and 2
Connection	VC1, VC2
Weight	55g (0.12 lbs)
Styling	Curved USB port doors
Port Protection	Twin, self-closing doors

## Environmental

Sealing	IP64 for front panel components when USB Ports are covered
Operating Temperature	-40° to +60°C at 3.15A -40° to +70°C at 2.4A -40° to +80°C at 2.1A
Vibration 1 Test	Mil-Std 202G, Method 204D, Condition A. 0.06DA or 10G, 10-500 Hz
Shock Test	Mil-Std 202G, Method 213B, Condition K @ 30-G. No loss of circuit during test.
Chemical Splash	Brush testing with USB doors closed: diesel, gasoline, brake fluid, Windex, Armor All
Thermal Shock	MIL-Std 202F, Method 107D, Test Condition A, -55° to +85°C. Test Criteria: Remains functional without damage
Moisture Resistance	Mil-Std 202G, Method 106G. Test Criteria: Remains functional without damage
Thermal Cycling	25 Cycles -40° to +85°C, 2 hours for each temperature every cycle
Salt Spray	Mil-Std 202G, Method 101E, Test Condition A
Dust	Mil-Std 841C Method 510.2 Air Velocity 300 $\pm$ 200 Ft/min, test duration: 16 Hr

## Mechanical

Endurance	10,000 door cycles minimum
-----------	----------------------------

### Ordering Scheme

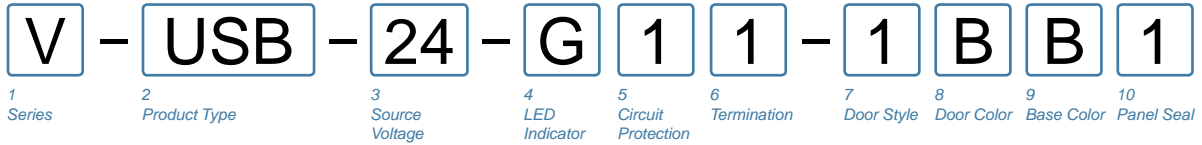

<b>1 SERIES</b> <b>V</b>	<b>6 TERMINATION</b> <b>1</b> .250 Tab
<b>2 PRODUCT TYPE</b> <b>USB</b> Charger	<b>7 DOOR STYLE</b> <b>1</b> Curved
<b>3 SOURCE VOLTAGE</b> <b>24</b> 24 / 12 Volts DC	<b>8 DOOR COLOR</b> <b>B</b> Black
<b>4 LED INDICATOR (VOLTAGE MATCHES SOURCE)</b> <b>G</b> Green	<b>9 FRAME COLOR</b> <b>B</b> Black
<b>5 CIRCUIT PROTECTION</b> <b>1</b> Reverse Polarity, Thermal Overload & Overcurrent	<b>10 PANEL SEAL</b> <b>1</b> Yes

### Dimensional Specifications: in. [mm]

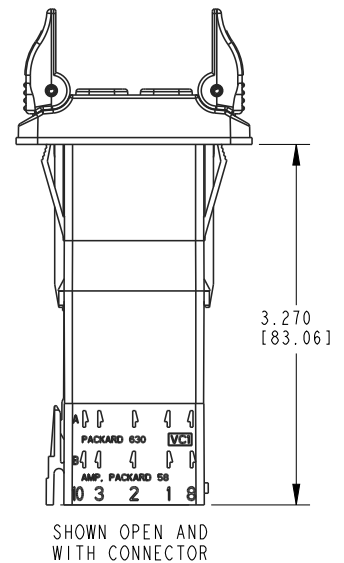
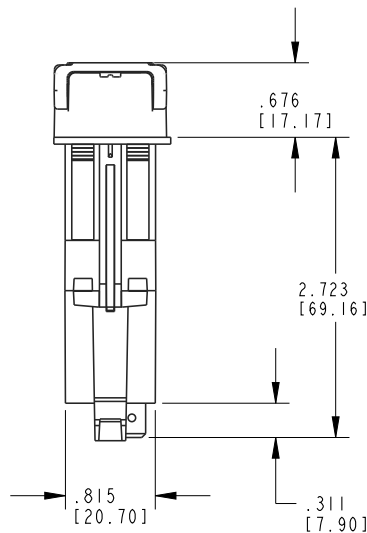
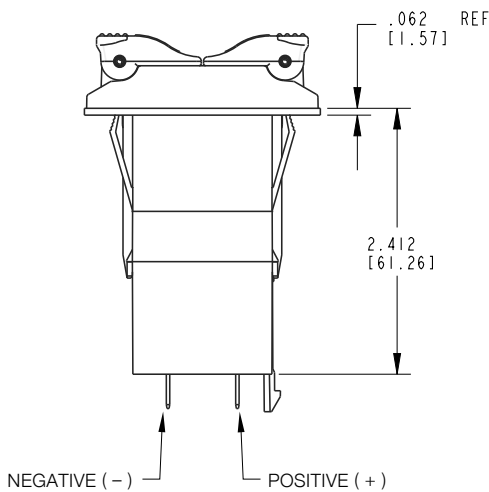
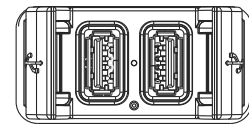
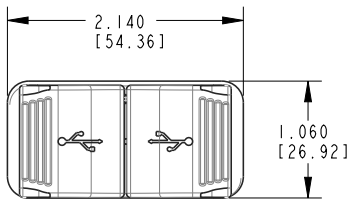

Notes:  
 1 Charger to install into 1.450" X 0.830" panel opening

**Reduce inventory levels and cost by stocking actuators and base switches separately.**

**Contura II, III, IV, V, VI, VII, X, XI, XII, XIV Base switches separately:** specify **V** with code selections 2-8 in the ordering schemes.

**Contura II, III, IV, V Actuator only:** **VV** with code **A** or **C** for selection 9, & with selections 10-14 in the ordering schemes.

**Contura VI Actuator with lenses and inserts only:** **VV** with code selections 9-16

**Contura II, III, IV, V, VII Actuator only:** **VV** with code **A, C, E, G, P** or **Z** for selection 9 & with selections 10-14 in the ordering schemes.

**Contura X, XI, XII, XIV actuators with lenses separately:** **VV** with code selections 9-14 in the ordering schemes.

Panel Seal: VPS

**Contura X & XI actuators without lenses separately:**

**VVR 6 1 00 1**

1 Actuator Separately 2 Actuator Style/Color 3 Lens Opening 4 Actuator Legend 5 Legend Orientation

**1 CONTURA X & XI ACTUATOR SEPARATELY**  
**VVR**

**2 ACTUATOR STYLE & COLOR**

	Black	Gray	White	Red
Contura X	1	2	3	4
Contura XI	6	7	8	9

**3 LENS OPENING FOR 1**

1 One bar lens 5 square lens on top/  
2 One bar lenses bar lens on bottom  
3 One square lens (Contura X only)  
4 two square lens

**4 ACTUATOR LENS OR BODY LEGEND**

**00** - No Legend this location  
**11** ON OFF **13** I O **14** O I  
**15** O O **16** O O **17** O I **18** I O  
F N N F F F



For additional legend options & codes, visit us at [www.carlingtech.com](http://www.carlingtech.com).

**5 LEGEND ORIENTATION 1**

**0** No legend  
**1** Orientation 1  
**2** Orientation 2  
**3** Orientation 3  
**4** Orientation 4

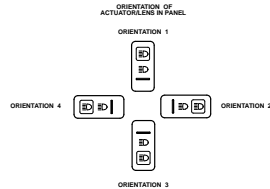

**Contura X, XI & XII top piece of 2-piece lens separately:**

**VVT 1**

1 Lens Separately 2 Color

**1 TOP OF LENS SEPARATELY**  
**VVT**

**2 COLOR**  
1 Clear 2 Smoke 3 White

**Contura X, XI & XII actuator lens assembly:**



1 piece lens/bar lens are positioned the same as bottom lens for assembly, minus the top lens. Lenses snap in from bottom.

**Notes:**

- If actuator lens opening for 2 bar or 2 square lenses, legend orientation 0,1, or 2 must be chosen.
- Center of actuator marking not available for Contura XII.
- Legend is not available for bar style lens.
- Not recommended with neon lamps.
- Must also order top piece of 2 piece square lens separately.

**Contura XII actuators without lenses separately:**

**VVP J 1 Z 21 1 00**

1 Actuator 2 Style & Color 3 Lens Opening 4 Lens Opening 5 Legend 6 Legend Orientation 7 Legend Orientation

**1 CONTURA XII ACTUATOR SEPARATELY**  
**VVP**

**2 ACTUATOR STYLE & COLOR**

**J** Black **K** Gray **N** White **M** Red

**3,4 LENS OPENING FOR**

**Z** No lens 1 Bar lens 2 Square lens

**5, 7 LENS OR BODY LEGEND 2**

**00** - No Legend **21** OFF **22** ON **23** O **24** I  
**25** O **26** O **27** O **28** I  
F F N



For additional legend options & codes, visit us at [www.carlingtech.com](http://www.carlingtech.com).

**6 LEGEND ORIENTATION 3**

**0** No legend  
**1** Orientation 1  
**2** Orientation 2

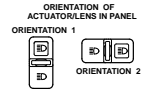

**Contura X, XI & XII actuator lens assembly separately:**

**VVL 2 1 00 0**

1 Lens Separately 2 Lens Style 3 Lens Color 4 Legend 5 Legend Orientation

**1 CONTURA X, XI & XII LENS SEPARATELY**  
**VVL**

**2 LENS STYLE 3**

1 Bar lens  
2 One Piece Square lens  
3 Bottom of Two-Piece Square lens 5

**3 TRANSLUCENT LENS COLOR**

1 Clear 2 White 3 Amber 4 Green 4 5 Red 6 Blue 4

**4 LENS OR BODY LEGEND 2**

**00** - No Legend **21** OFF **22** ON **23** O **24** I  
**25** O **26** O **27** O **28** I  
F F N



For additional legend options & codes, visit us at [www.carlingtech.com](http://www.carlingtech.com).

**5 LEGEND ORIENTATION 3**

**0** No legend  
**1** Orientation 1  
**2** Orientation 2  
**3** Orientation 3  
**4** Orientation 4

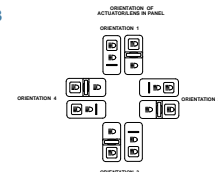

## Easily integrate Contura products into your system, with Contura Accessories

### Contura Connectors

Q.C. SELECTION GUIDE					
COMPANY SERIES	PART NO		WIRE RANGE		ORIENTATION
	PLAIN BRASS	TIN PLATED BRASS	AWG	MM <sup>2</sup> (REF)	
PACKARD 58 SERIES	02965580		12	3.0	B
	02965471	12010601	(2)16-14	(2)1.0-2.0	
	02965470		16-14	1.0-2.0	
	02965469	06288318	20-18	.5-.8	
PACKARD METRI-PACK 630 SERIES		12084590	10	5.0	A
		12052224	12	3.0	
		12015870	16-14	1.0-2.0	
		12020035	(2)22-18	(2).5-.8	
	12015832	12015869	20-18	.5-.8	
AMP 250 SERIES FASTIN-FASTON	60253-1	60253-2	16-12	1.3-3	B
	42100-1	42100-2	(2) 16	(2) 1.3	
	60295-1	60295-2	22-18	.3-.9	

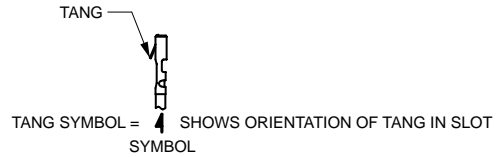

**NOTE:** Consult Delphi Packard and/or Amp on actual part numbers and availability. AMP is a registered trademark of AMP Inc. Harrisburg, PA. Delphi Packard is a registered trademark of Delphi-Packard Electrical Systems Warren, Ohio

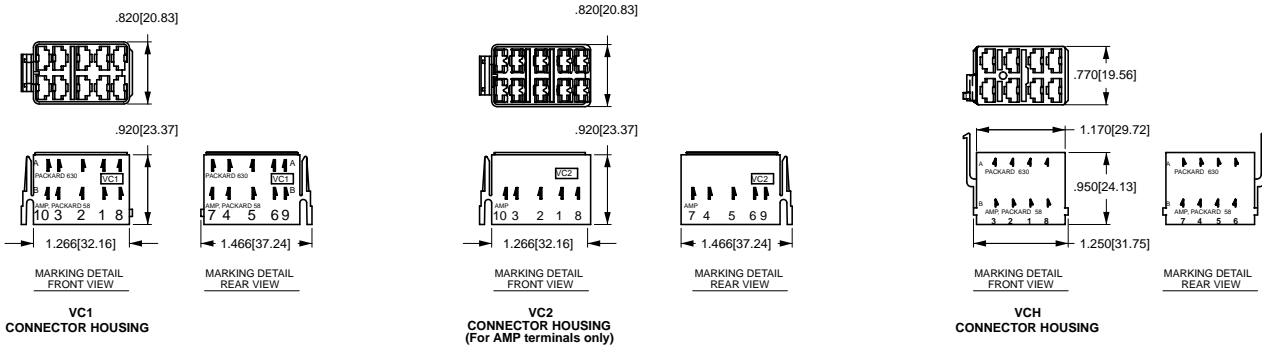

### Contura X Boot (P/N VB1-01)

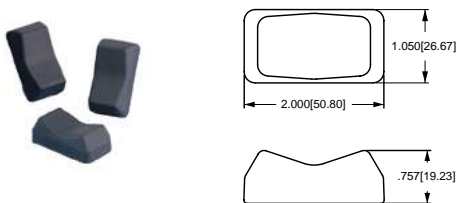

### Contura II, III, IV & V Actuator Removal Tool (P/N VRT)

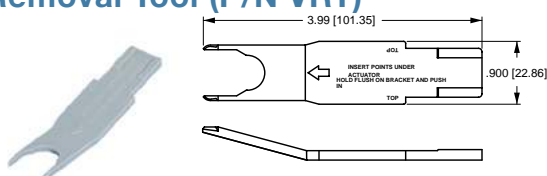

### Additional V-Series Ratings

- 1 .4VA @ 28VDC Resistive
- 4 10A 250VAC 1/2 HP, 15A 125 VAC 1/2 HP, No Agency Listings
- 5<sup>1</sup> 10A 250VAC 1/2 HP, 15A 125 VAC 1/2 HP, UL Recognized, CSA Certified
- 6<sup>2</sup> 15A 125VAC 1/2 HP, 12(2)A 125 VAC μ T85
- 7<sup>2</sup> 15A 125VAC 1/2 HP, 12(6)A 125 VAC T85
- 8<sup>2</sup> 10A 250VAC, 15A 125VAC, 1/2 HP 125-250VAC, 12(2)A 250 VAC μ T85
- 9<sup>2</sup> 10A 250VAC, 15A 125VAC, 1/2 HP 125-250VAC, 12(6)A 250 VAC T85
- B 15A 24V
- C 20A 18V
- D 20A 12V
- E 20A 14V, 10A 14VT (circuits 1, 4, A, & D only)
- F 10A 14V, 6A, 14VT (circuit G only)
- G 20A 6V
- H 20A 3V
- L 15A 125 VAC, 10A 250VAC, 1/2 HP 125-250 VAC; 6A 125 VAC L
- M .4VA/20A 12V (combi-contact)  
(combination gold/silver contacts for borderline dry circuit applications)
- N .4VA/15A 24V (combi-contact)  
(combination gold/silver contacts for borderline dry circuit applications)

#### NOTES

Consult factory to determine availability for individual circuits and their HP rating.

1. Not available with Contura 7 or 14 rocker styles.
2. Ratings 6 - 9 are UL, CSA & VDE certified, require terminations A or B for double pole circuits, & are not available with illumination circuits 4, 8, D, J, N, & T or with wire lead or solder lug terminations.

Circuits 1, 4, A, D, H, M & E are not available with rating 6 & 8. Rating 7 & 9 only available with circuits 1, 4, A & D. Circuits 2, 3, 5, 7, 8, K, L are 1/2 HP 250VAC only with rating 8. Ratings 6 & 7 must specify lamp code 1 (125VAC neon). Ratings 8 & 9 must specify lamp code 2 (250VAC neon). Rating L available with circuits 1, 4, A & D only.

## Contura Mounting Panels

### Dimensional Specifications: in. [mm]

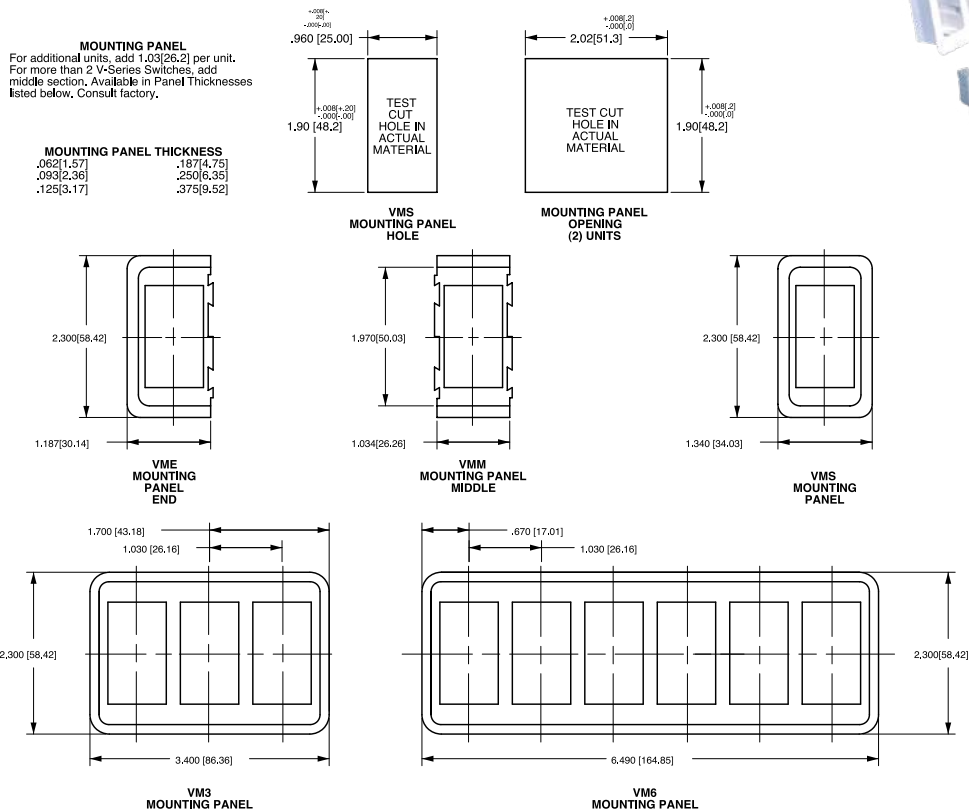

## Contura Hole Plug

### Dimensional Specifications: in. [mm]

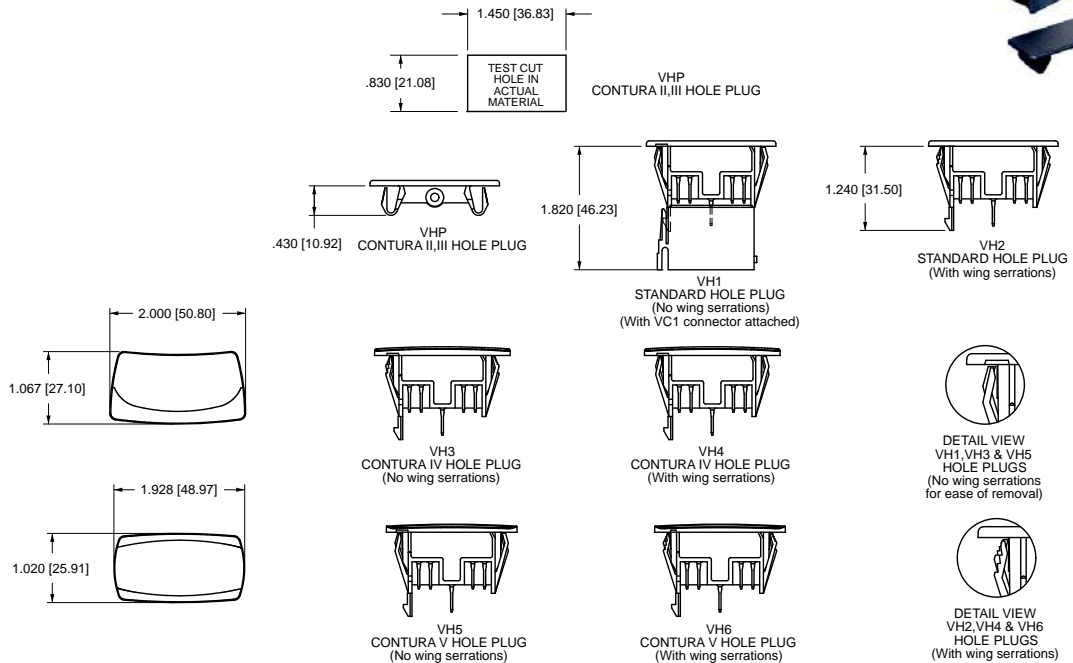

# W-Series

## SEALED ROCKER SWITCHES

Carling Technologies set the standard for performance and aesthetics with the widely successful, often imitated, but never duplicated, V-Series rocker switches. Building further upon that platform, Carling has once again raised the bar with the fully sealed W-Series. The W-Series' traditional appearance features complete IP68 protection, including below the panel, where the critical connection is made from the wiring harness. When used in conjunction with the integrated connector, the totally submersible W-Series provides a seal for up to ten individual wires, assuring compatibility with even the most complex circuitry.

The W-Series also offers a wide variety of accoutrements, including endless illumination options featuring dual level and multicolor LEDs, progressive and hazard warning circuits, ratings up to 10A 24V, choice of paddle, rocker, locking or laser etched actuators, hundreds of standard legend choices and the electrical performance and reliability that is the hallmark of Carling Technologies products.



### Product Highlights:

- ♦ Fully sealed and submersible
- ♦ IP68 protection, including below the panel
- ♦ Tri-seal design
- ♦ Connector with twin locking tabs



# W-Series Switch

## DESIGN FEATURES

### ILLUMINATION

Choice of highly reliable SMT LED or incandescent lighting with 21 dependent or independent circuit options.

### TRI-SEAL DESIGN

Sealing at actuator, an insert molded neoprene base seal, along with wire lead seals, assures water tight, fully submersible protection.

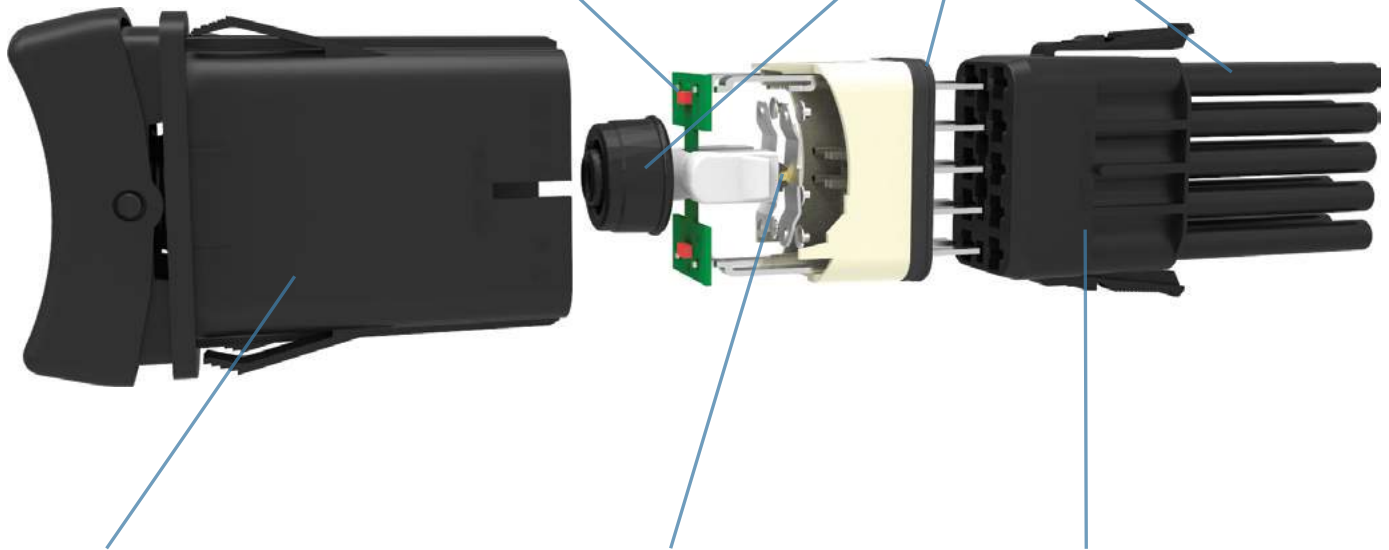

### BODY

One piece polyester 94V0 seamless body acts as an umbrella to protect critical internal components.

### ROLLER PIN

Proven reliable mechanism is lubricant free and allows for 100k electrical and 250k mechanical cycles, and withstands extreme temperatures from -40°C to +85°C.

### INTEGRATED CONNECTOR

Accommodates Tyco/Amp .110 junior power timer contacts with twin locking tabs to provide a safe, secure, sealed connection.

### Electrical

Contact Rating	.4VA @ 24VDC 10 amps, 3-24VDC
Dielectric Strength	1500 Volts RMS
Insulation Resistance	50 Megaohms
Initial Contact Resistance	10 milliohms max. @ 4 VDC
Life	100,000 cycles
Contacts	Silver tin-oxide, 88/12
Terminals	Copper with silver or gold plating
Quick Connect	Connect terminations.
Voltage	3-24 VDC
Overcurrent	15A for 50 cycles

### Mechanical

Endurance	250,000 cycles minimum
-----------	------------------------

### Physical

Lighted	LED - rated 100,000 hours 1/2 life (LED is internally ballasted for voltages to 24 VDC)
Seals	Neoprene
Base	Polyester blend rated to 125C with a UL flammability rating of 94V0.
Actuator	Basic actuator structure molded of thermoplastic polycarbonate with a hard Nylon 66 thermoplastic surface overlay.
Lens	Polycarbonate rated at 100°C
Function	2 & 3 Position Rocker Style
Operation	Maintained & Momentary
Base	PA 6/6 30GF (glass filled)
Actuator	PA 6/6 13GF
Bracket	PBT 10GF
Connector	PBT 10GF, polarized

### Actuator Travel (Angular Displacement)

24° full throw

### Environmental

Environmental	IP68, Fully sealed
Corrosion/ Chemical Splash	Flowing Mixed Gas (FMG) Class III 3 year accelerated exposure per ASTM B-827, B-845 -40°C to +85°C, 22 cycles, 300 hours
Operating Temperature	Per Mil-Std 202F, Method 204D Test Condition A 0.06 DA or 10G's 10-500 Hz.
Vibration 1	Resonance search 24-50 Hz 0.40 DA 50-2000 ±10 G's peak Results Horizontal Axis 3-5 G's max.
Vibration 2	Random 24 Hz 0.06 PSD-Gsq/Hz 60 Hz 0.50 100 Hz 0.50 200 Hz 0.025 2000 Hz 0.025
Handling/Drop Salt Spray	One meter onto concrete floor Per Mil-Std 202F, Method 101D, Test Condition A, 48 Hrs.
Dust	IP6X
Thermal Shock	Per Mil-Std 202F, Method 107F, Test Condition A, -55°C to 85°C Test criteria - pre and post test contact resistance
Moisture Resistance/ Humidity	Per Mil-Std 202F, Method 106F, Test Criteria - pre and post test contact resistance

### Mounting Specifications

Panel Thickness Range .032 to .125

For optimum panel fit, the following panel thicknesses are suggested: .032, .062, .093, .125

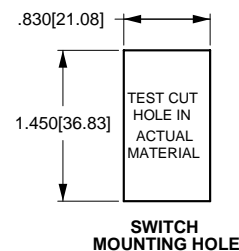

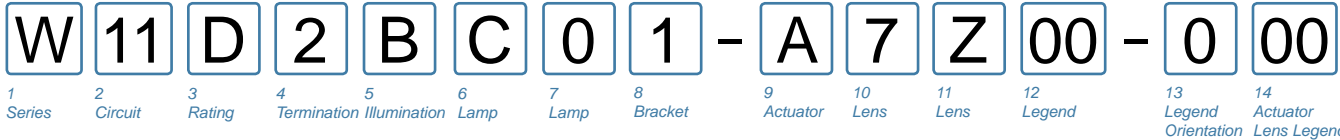

**1 SERIES**  
W

**2 CIRCUIT**  
Terminal Connections as viewed ( ) - momentary from bottom of switch: SP - single pole - uses terminals 1, 2 & 3. 8 terminal 10 terminal DP - double pole uses terminals 1, 2, 3, 4, 5 & 6. Terminals 7, 8, 9 & 10 for lamp circuit only.

8 - 7	8 - 7		
1 - 4	1 - 4		
2 - 5	2 - 5		
3 - 6	3 - 6		
	10 - 9		

Position:	1	2	3
SP	DP	2 & 3, 5 & 6	Connected Terminals 1 & 2, 4 & 5
11	21	ON	NONE
12	22	(ON)	NONE
13	23	ON	NONE
14	24	ON	NONE
15	25	ON	NONE
16	26	ON	OFF
17	27	ON	OFF
18	28	(ON)	OFF
-	49	ON	ON

**3 RATING**

B	10A 24V
D	10A 12V
G	10A 6V
H	10A 3V

**4 TERMINATION / BASE STYLE**

2	.110 TAB (QC)
---	---------------

**5 ILLUMINATION**  
Lamp #1: above terminals 1&4 end of switch.; Lamp #2 above terminals 3&6 end of switch. Positive (+) and negative (-) symbols apply to LED lamps only

Lamps	Actuator Lens Position	Illumination Type	Lamp Wired to Terminals
O	NONE		
A	# 1	Independent	8+ 7-
B	# 1	Down	3+ 7-
C	# 2	Up	3+ 7-
D	# 1	Down	3+ 7-
	& # 2	Down	1+ 7-
E	# 1	Up	1+ 7-
	& # 2	Up	3+ 7-
F	# 1	Independent	8+ 7-
	& # 2	Up	3+ 6-
G	# 1	Independent	8+ 7-
	& # 2	Up	3+ 7-
H	# 2	Independent	8+ 7-

Selections for Single Pole Switches Only:

J	# 1	Down	3+ 8-
	& # 2	Independent	6+ 7-
K	# 1	Independent	8+ 7-
	& # 2	Independent	6+ 7-

Selections for Double Pole Switches Only:

L	# 1	Down	3+ 6-
M	# 2	Up	3+ 6-
N	# 1	Down	3+ 6-
	& # 2	Down	1+ 4-
P	# 1	Up	1+ 4-
	& # 2	Up	3+ 6-
R	# 1	Down	3+ 7-
	& # 2	Up	6+ 7-
S	# 1	Down	6+ 7-
	& # 2	Independent	8+ 7-
U	# 1	Independent	8+ 7-
	& # 2	Independent	10+ 9-
V	# 2	Independent	10+ 9-
W	# 1	Independent	8+ 7-
	& # 2	Independent	10+ 7-
Y	# 1 & # 2	Independent in Series	8+ 7-
Z	# 1 & # 2	Independent in Parallel	8+ 7-

**6,7 LAMP (SAME CODING FOR BOTH SELECTIONS)**  
Selection 6: above terminals 1 & 4; Selection 7: above terminals 3 & 6

No lamp	0
LED*	
2VDC	Red
6VDC	Amber
12VDC	superbright Green
24VDC	White

\* Consult factory for "daylight bright", blue/green and white LED options. Typical current draw for LED is 20ma.

**8 BRACKET COLOR 1**

1	Black
---	-------

**9 ACTUATOR 1,3**

3	Black with Laser Etched
A	Black

**10 LENS - ABOVE LAMP #1 TERMINALS 1,4**  
**11 LENS - ABOVE LAMP #2 TERMINALS 3,6**

0	No Actuator	Z	No Lens
	Clear		White
1	-	B	Amber
	7	C	Green
3	-	D	Red
	9	E	Blue
5	A	-	-

	G	M	T	Large Transparent
	H	N	U	Large Translucent
	J	P	V	Bar Transparent
	K	R	W	Bar Translucent
	-	-	-	Laser-Etched

Lens color for LEDs must be clear, white, or match color of LED.

**12 ACTUATOR LENS OR BODY LEGEND 2**

00	No Legend this location/No actuator
11	ON OFF
12	OFF ON
13	I O
14	O I
15	O O
16	O O
17	O I
18	I O
21	OFF
22	ON
23	O
24	I
25	O
26	O
27	O
28	I

For additional legend options & codes, visit us at [carlingtech.com](http://carlingtech.com)

**13 LEGEND ORIENTATION**

0	No legend (used with codes 11-18 in selection 12)
1	Orientation 1
2	Orientation 2
3	Orientation 3
4	Orientation 4

**14 ACTUATOR LENS LEGEND 2**

00	No legend this location/no actuator (used with codes 11-18 in selection 12) Selection 14 required when switch requires two legends. If the two legends consist of one lens & one body legend, lens legend must be specified in selection 12; body legend specified in selection 14. For legend options & codes, visit us at <a href="http://carlingtech.com">carlingtech.com</a>
----	--

Notes:  
1 Custom colors are available. Consult factory.  
2 White imprinting is standard on black actuators; Black imprinting is standard on white, red & gray actuators; Custom colors are available, consult factory.  
3 Locking rocker version is also available, consult factory for details.

Dimensional Specifications: in. [mm]

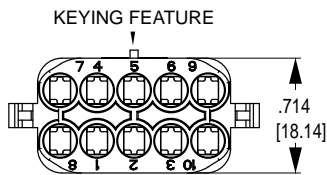
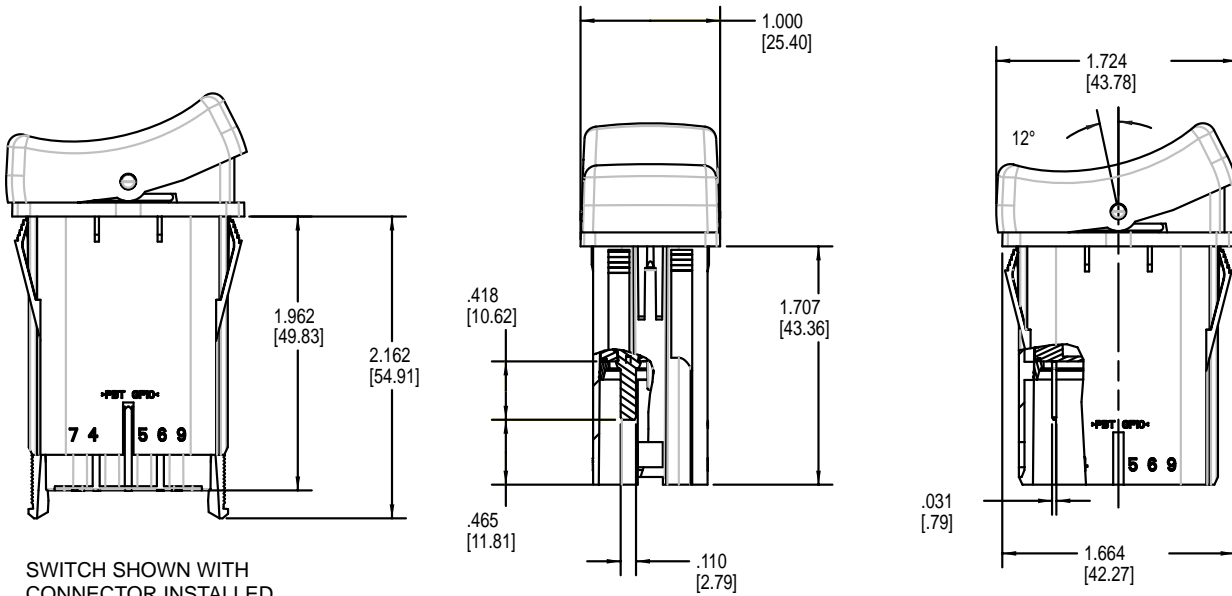
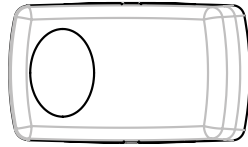

WCH CONNECTOR  
(190-31214-001)

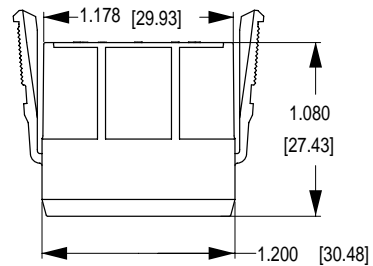

Notes:  
 WCH connector is intended for use with Tyco/Amp .110 Junior Power Timer, female contacts, and wire seals.  
 For 14-16 awg wire, specify Tyco/Amp P/N 927766-3  
 For 16-20 awg wire, specify Tyco/Amp P/N 927770-3  
 Tyco/Amp cable seal P/N 828904-1 (20-18 awg wire) or P/N 828905-1 (16-14 awg wire) is required for each individual wire lead, and Tyco/Amp cable plug, P/N 828922-1, is required to seal each unused connector opening. Consult Tyco/Amp for the cable seal recommended for your specific wire gauge and thickness.

# LT-Series

## TOGGLE SWITCHES

The LT-Series illuminated toggle switches feature up to a three-color lighting sequence from a single lamp. These lighted toggles contain neoprene bushing seals for dust and moisture protection. A variety of circuits and terminations are available.



### Product Highlights:

- 1 or 2 Pole
- Independent or Dependent Illumination
- Choice of 5 Actuator Styles
- Up to 3 different colors under a single lens

### Dielectric Strength

1000V - live to dead metal parts

### Electrical Life

50,000 cycles - maintained  
25,000 cycles - momentary

### Mechanical Life

100,000 cycles

### Operating Temperature

32°F to 185°F (0°C to 85°C)

**LT-1561 - 1 30 - 012**

1  
Base Part Number

2  
Actuator Style

3  
Lighting Sequence

4  
Lamp Voltage

#### 1 BASE PART NUMBER: SERIES / POLES / ILLUMINATION / CIRCUITRY / RATING / TERMINATION<sup>5</sup>

	Solder Lug	.250 Tab QC	Screw Terms	Wire Leads
<b>Single Pole</b>				
On-None-Off	LT-1510	LT-1511	LT-1514	LT-1515
On-None-(Off)	LT-1520	LT-1521	LT-1524	LT-1525
(On)-None-Off	LT-1530	LT-1531	LT-1534	LT-1535
On-None-On	LT-1540	LT-1541	LT-1544	LT-1545
On-None-(On)	LT-1550	LT-1551	LT-1554	LT-1555
On-Off-On	LT-1560	LT-1561	LT-1564	LT-1565
On-Off-(On)	LT-1570	LT-1571	LT-1574	LT-1575
(On)-Off-(On)	LT-1580	LT-1581	LT-1584	LT-1585
<b>Double Pole</b>				
On-None-Off	LT-2510	LT-2511	LT-2514	LT-2515
On-None-(Off)	LT-2520	LT-2521	LT-2524	LT-2525
(On)-None-Off	LT-2530	LT-2531	LT-2534	LT-2535
On-None-On	LT-2540	LT-2541	LT-2544	LT-2545
On-None-(On)	LT-2550	LT-2551	LT-2554	LT-2555
On-Off-On	LT-2560	LT-2561	LT-2564	LT-2565
On-Off-(On)	LT-2570	LT-2571	LT-2574	LT-2575
(On)-Off-(On)	LT-2580	LT-2581	LT-2584	LT-2585

#### 2 ACTUATOR STYLE

Paddle <sup>1</sup>	
1	Clear Paddle
4	Solid Color Paddle

#### Snapkap Style<sup>2</sup>

5	Bright Chrome
6	Satin Chrome
7	Black Molded

#### Notes:

- Solid color paddle available with lighting sequence 01, 02, 10 or 20.
- SnapKap Toggle Lenses are available separately. Consult factory.
- Independent lamp is standard. Dependent lamp with ON-OFF function (including momentary) is available with Lighting Sequences 10, 20, 30, 40 and 50. (No light in OFF position.)
- Green and blue not recommended with 125 volt or 250 volt neon lamps.
- Additional terminations available. Consult factory for details.
- ( ) Indicates momentary function.

#### 3 LIGHTING SEQUENCE<sup>3,4</sup>

	position 1	position 2	position 3
01	red	red	red
02	amber	amber	amber
03	green	green	green
10	red	---	none
11	red	clear	red
12	red	clear	red amber
13	red	clear	green
14	red	clear	blue
15	red	clear	clear
20	amber	---	none
21	amber	clear	red
22	amber	clear	amber
23	amber	clear	green
24	amber	clear	blue
25	amber	clear	clear
30	green	---	none
31	green	clear	red
32	green	clear	amber
33	green	clear	green
34	green	clear	blue
35	green	clear	clear
40	blue	---	none
41	blue	clear	red
42	blue	clear	red amber
43	blue	clear	green
44	blue	clear	blue
45	blue	clear	clear
50	clear	---	none
51	clear	clear	red
52	clear	clear	amber
53	clear	clear	green
54	clear	clear	blue
55	clear	clear	clear

#### 4 LAMP VOLTAGE<sup>4</sup>

incandescent		neon	
006	6 volt	125N	125 volt neon
012	12 volt	250N	250 volt neon
018	18 volt		
024	24 volt		

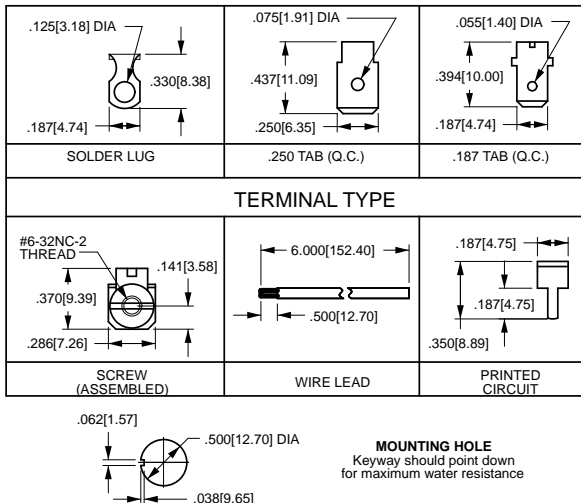
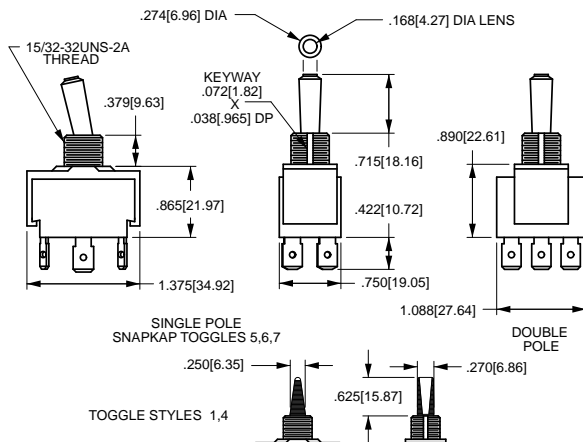

# F-Series

## SINGLE POLE TOGGLE SWITCHES

General purpose workhorses with options tailored to meet most any need. Ratings to 20A 277VAC, various actuator, bushing, termination, and circuit choices allow this versatile switch to easily integrate into a variety of different applications. The F-Series is appropriate for usage in low voltage DC applications.



### Resources:

[Download 3D CAD Files](#)

[IGS >](#)

[STP >](#)

### Product Highlights:

- ♦ Ratings to 20A
- ♦ Suitable for low voltage 12/24V DC
- ♦ Variety of termination options
- ♦ Consult factory for large choice of bushing/toggle length combinations

### Dielectric Strength

1000V - live to dead metal parts

### Electrical Life

50,000 cycles - maintained  
25,000 cycles - momentary

### Mechanical Life

100,000 cycles

### Operating Temperature

0°F to 150°F (-17.8°C to +65.6°C)

**2FA54 - 73 / TABS**

1 Base Part Number

2 Actuator Style

3 Tab Terminals

#### 1 BASE PART NUMBER: SERIES / CIRCUITRY / RATING / TERMINATION<sup>1</sup>

10A 250VAC; 15A 125VAC; 3/4 HP 125-250VAC

	Solder Lug	.250 Tab QC	Screw Terminals
On-None-Off	2FA53	2FA53-.../TABS	2FA54
(On)-None-Off	6FA53	6FA53-.../TABS	6FA54
On-None-(Off)	6FA57	6FA57-.../TABS	6FA58
On-None-On	2FB53	2FB53-.../TABS	2FB54
On-None-(On)	6FB53	6FB53-.../TABS	6FB54
On-Off-On	2FC53	2FC53-.../TABS	2FC54
On-Off-(On)	6FC53	6FC53-.../TABS	6FC54
(On-Off)-(On)	6FC53	6FC53-.../TABS	6FC54

Additional ratings up to 20A 125VAC, 12A 250VAC, 1HP 120-240 VAC available. Consult factory for specifics.

#### 2 ACTUATOR STYLE BAT STYLE TOGGLE<sup>2</sup>

	unsealed	sealed	toggle length	bushing length
73	78	78	0.687	0.465
E3	E8	E8	2.000	0.465

#### 3 TAB TERMINALS

/TABS Tab Terminals  
(blank) Leave blank if tab terminals not required.

#### Notes:

- 1 Consult factory for .187 tab, wire lead and combination screw/tab/solder lug callouts.
- 2 Additional toggle options are available. Consult factory.
- ( ) indicates momentary function.

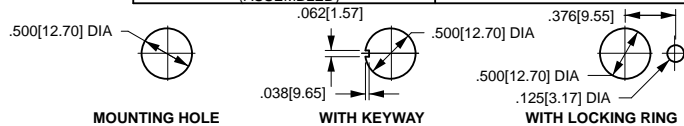
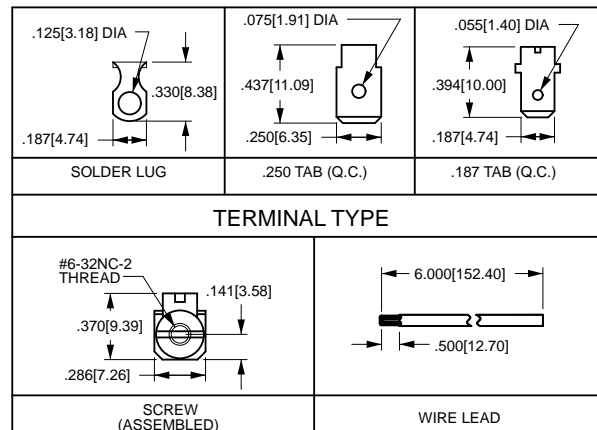
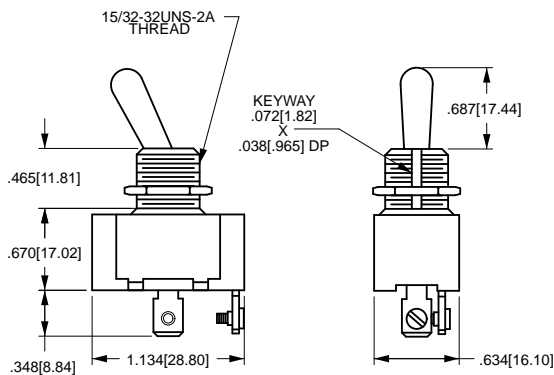

\*Manufacturer reserves the right to change product specification without prior notice.



# G-Series

## TOGGLE SWITCHES

General purpose workhorses with options tailored to meet most any need. Ratings to 20A 277VAC, international approvals, various actuator, bushing, termination, and circuit choices allow this toggle switch to easily integrate into a variety of different applications. The G-Series is appropriate for usage in low voltage DC applications.



### Resources:

*Download 3D CAD Files*

[IGS >](#)

[STP >](#)

### Product Highlights:

- ♦ Ratings to 20A 277VAC available
- ♦ Metal bat or nylon bat/paddle actuator styles
- ♦ UL, CSA and VDE approvals for select circuits
- ♦ Suitable for low voltage 12/24V DC

### Dielectric Strength

UL/CSA: 1000V - live to dead metal parts & opposite polarity

VDE: 4000V - live to dead metal parts; 1250V - opposite polarity & across open contacts

### Electrical Life

50,000 cycles - maintained  
25,000 cycles - momentary

### Mechanical Life

100,000 cycles

### Operating Temperature

32°F to 185°F (0° to 85°C)

# 2GM51 - 73

<sup>1</sup>  
Base Part Number

<sup>2</sup>  
Actuator Style

**1 BASE PART NUMBER: SERIES / CIRCUITRY / RATING / TERMINATION <sup>3</sup>**

**Single Pole in Double Pole base**

10A 250VAC, 15A 125VAC, 3/4 HP 125-250VAC			Double Pole		
solder lug	.250 tab	screw term.	solder lug	.250 tab	screw term.
2GA50	2GA51	2GA54	2GK50	2GK51	2GK54
6GA5A	6GA5B	6GA5E	6GK5A	6GK5B	6GK5E
6GA5L	6GA5M	6GA5S	6GK5L	6GK5M	6GK5S
2GB50	2GB51	2GB54	2GL50	2GL51	2GL54
6GB5A	6GB5B	6GB5E	6GL5A	6GL5B	6GL5E
2GC50	2GC51	2GC54	2GM50	2GM51	2GM54
6GC5A	6GC5B	6GC5E	6GM5A	6GM5B	6GM5E
6GC5L	6GC5M	6GC5S	6GM5L	6GM5M	6GM5S

**10A 250VAC, 15A 125VAC, 12 (6)A 250VAC T85/55 ENEC/VDE Approved <sup>1</sup>**

2GA90	2GA91	-	On-None-Off	2GK90	2GK91
2GB90	2GB91	-	On-None-On	2GL90	2GL91
2GC90	2GC91	-	On-Off-On	2GM90	2GM91

Additional ratings up to 20A 125VAC, 12A 250VAC, 1HP 120-240 VAC available. Consult factory for specifics.

**2 ACTUATOR STYLE <sup>4</sup>**

BAT	unsealed	sealed	toggle length	bushing length
PADDLE <sup>5</sup>	73	78	0.687	0.465
BAT <sup>2</sup>	NBL3	NBL8	0.687	0.465
PADDLE <sup>2</sup>	D-3B-B	-	0.687	0.379
	-	D-4B-B	0.687	0.379

- Notes:
- Not available with 73 or NBL3 style toggles, T55 with 78 and NBL8 style toggles.
  - All nylon bushing and toggle.
  - Consult factory for .187 tab, wire lead and combination screw/tab/solder lug termination callouts.
  - Additional actuator options available. Consult factory.
  - Nylon toggle with black ebanol plated bushing.
  - ( ) Indicates momentary function.

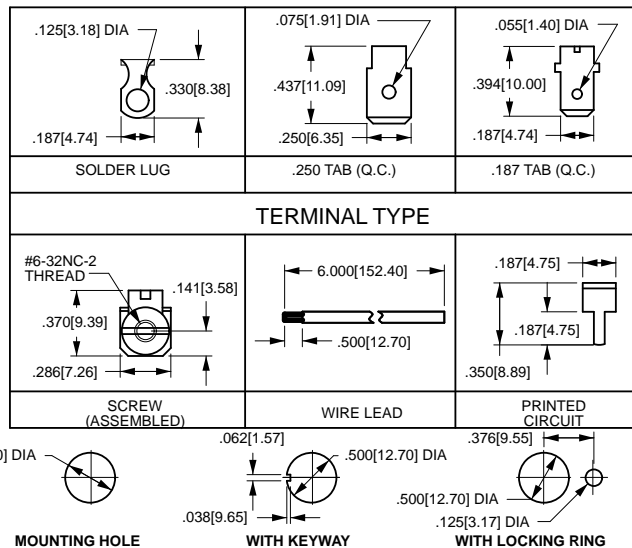
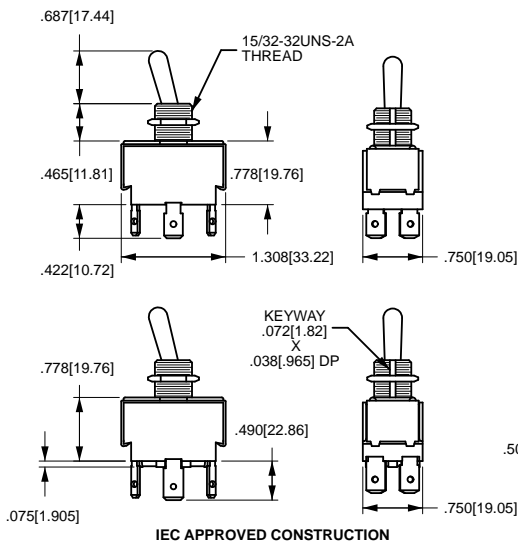

\*Manufacturer reserves the right to change product specification without prior notice.

# P27-Series

## P27-Series

### PUSHBUTTON SWITCHES

The P27-Series pushbutton switches are single pole, AC rated switches suitable for general purpose applications with a shallow back panel. These switches are momentary action with a medium actuation force (26 oz. typical). The P27-Series switch is equipped with a slow-make, slow-break contact mechanism, rated at 6 amps with a nylon concave pushbutton.

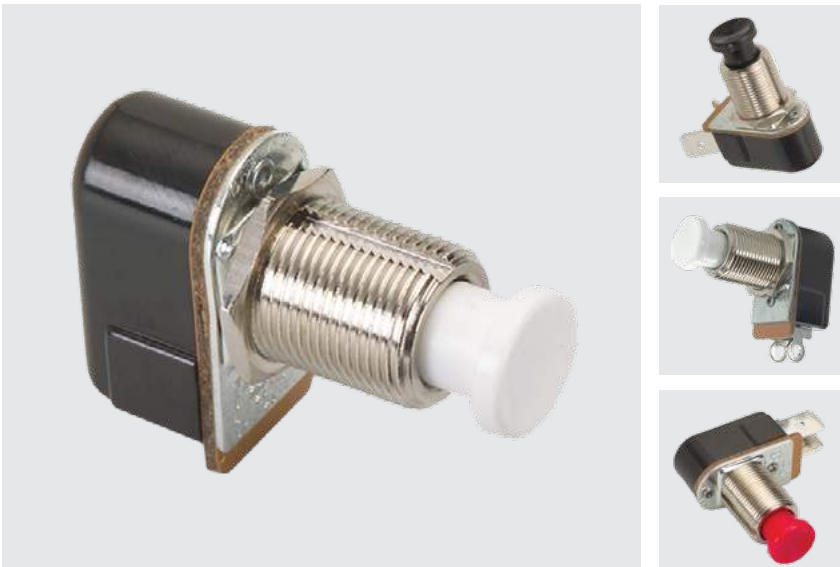

#### Product Highlights:

- ◆ Ratings to 6A 125VAC 3A 277VAC
- ◆ Momentary On or Momentary Off circuitry
- ◆ .250 Tab, Solder Lug or Wire Lead terminations
- ◆ Shallow space saving envelope

### Dielectric Strength

UL/CSA: 1000V - live to dead metal parts

### Electrical Life

25,000 cycles

### Mechanical Life

100,000 cycles

### Operating Temperature

32°F to 185°F (0°C to 85°C)

**P27A** - **BL**

<sup>1</sup>  
Base Part Number

<sup>2</sup>  
Button Color

**1 BASE PART NUMBER: SERIES / POLES / CIRCUITRY / RATING / TERMINATION**

Single Pole	Solder Lug	.250 Tab	Wire Leads
<b>3A 250VAC, 6A 125 VAC, 3/4A 125V</b>			
Off - (On)	<b>P27A</b>	<b>P27B</b>	<b>P27F</b>
On - (Off)	<b>P27L</b>	-	<b>P27T</b>

**3 BUTTON STYLE / COLOR**

<b>BL</b>	Black
<b>RD</b>	Red
<b>WH</b>	White

Notes:  
( ) Indicates momentary function.

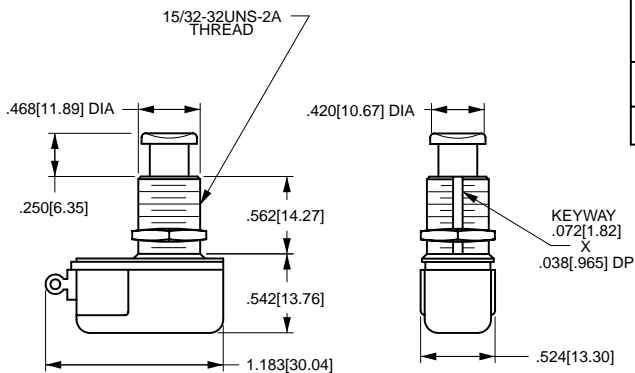

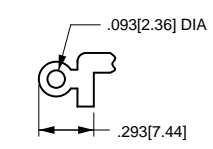
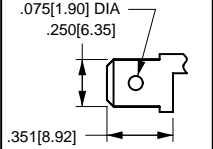
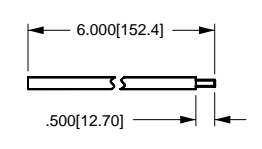
 .093[2.36] DIA .293[7.44]	 .075[1.90] DIA .250[6.35] .351[8.92]	 6.000[152.4] .500[12.70]
SOLDER LUG	.250 TAB (Q.C.) (Momentary ON only)	INTEGRATED WIRE LEAD (no exposed conductors)
<b>TERMINAL TYPE</b>		



# M-Series

## CIRCUIT BREAKER

The M-Series is a low cost, miniature, hydraulic-magnetic circuit breaker which features a compact, space saving design, front panel snap-in mounting and a vertically mounted parallel pole configuration. It features various styling options to maximize your design flexibility. Choices include rocker, illuminated rocker, paddle and baton style handle actuators, push-to-reset and push-pull pushbutton actuators, as well as Visi-Rocker two color actuators. Our exclusive Rockerguard bezel helps prevent inadvertent actuation and a wiping contact mechanism assures long-term reliability.

The M-Series circuit breakers are available with 1, 2 or parallel poles, 0.02 to 50 amp ratings, and 125 and 250VAC or 80VDC versions. With over 16 different time delays, 5 terminal styles, a variety of panel hardware, various colors, and legend imprinting, it assures suitability for most any application design.



### Resources:

Download 3D CAD Files

[IGS >](#)

[STP >](#)

### Product Highlights:

- Parallel pole configuration fits in one rack unit
- MIL-PRF-55629
- MIL STD 202 compliant
- MIL-PRF-39019F ingress protection
- Sealed toggle actuator
- Compact design

Only Marine applicable ordering schemes and drawings are shown in this catalog.  
For complete product details, please visit [www.carlingtech.com](http://www.carlingtech.com)

**Electrical**

Maximum Voltage 125/250 VAC 50/60 Hz, 80 VDC (See Rating Tables.)

Current Ratings Standard current coils: 0.100, 0.250, 0.500, 0.750, 1.00 thru 15.0 in 1 amp increments, 18.0, 20.0, 25.0, 30.0. Other ratings available - see Ordering Scheme.

Auxiliary Switch Rating SPDT; 7A 250VAC, 7A (Res) 28VDC, 4A (Ind.) 28VDC, 0.25A 80VDC (Res) (silver contacts), 0.1A 125VAC (gold contacts).

Insulation Resistance Minimum of 100 Megohms at 500 VDC.

Dielectric Strength UL, CSA 1500V, 50/60 Hz for one minute between all electrically isolated terminals. M-Series Circuit Breakers comply with the 8mm spacing and 3750 V 50/60Hz dielectric requirements from hazardous voltage to operator accessible surfaces, per Publications IEC 380, 435, 950, EN 60950 and VDE 0805.

Resistance, Impedance Values from Line to Load Terminal - based on Series Trip Circuit Breaker.

**Mechanical**

Endurance 10,000 ON-OFF operations @ 6 per minute with rated Current and Voltage.

Trip Free All M-Series Circuit Breakers will trip on overload, even when actuator is forcibly held in the ON position.

Trip Indication The actuator moves positively to the OFF position when an overload causes the circuit breaker to trip.

**Physical**

Number of Poles 1 or 2

Internal Circuit Configs. Series with or without Auxiliary Switch. Switch Only with or without Auxiliary Switch.

Weight Approximately 30 grams/pole (Approximately 1.07 ounces/pole)

Standard Colors See Ordering Scheme.a

**Environmental**

Designed in accordance with requirements of specification MIL PRF-55629 & MIL-STD-202G as follows:

Shock Withstands 100 Gs, 6ms, sawtooth while carrying rated current per Method 213, Cond. I. Instantaneous curves tested at 80% of rated current.

Vibration Withstands 0.060" excursion from 10-55 Hz, and 10 Gs 55-500 Hz, at rated current per Method 204C, Test Condition A. Instantaneous curves tested at 80% of rated current.

Moisture Resistance Method 106D, i.e., ten 24-hour cycles @ + 25°C to +65°C, 80-98% RH.

Salt Spray Method 101, Condition A (90-95% RH @ 5% NaCl Solution, 96 hrs).

Thermal Shock Method 107D, Condition A (Five cycles @ -55°C to +25°C to +85°C to +25°C).

Operating Temperature -40° C to +85° C

Chemical Resistance Only the outside surfaces of the case and the handles may be cleaned with detergents or alcohol. Organic (hydrocarbon based) solvents are not recommended because they attack plastics. Caution should be taken when solvents are used to clean and remove flux from terminals. Lubricants should not be introduced into the handle/ bushing openings

RESISTANCE PER POLE VALUES from Line to Load Terminals (Values Based on Series Trip Circuit Breaker)

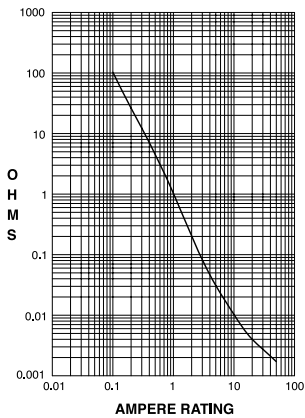

CURRENT (AMPS)	TOLERANCE (%)
0.10 - 20.0	± 25
20.1 - 50.0	± 35

**Pulse Tolerance Curves**

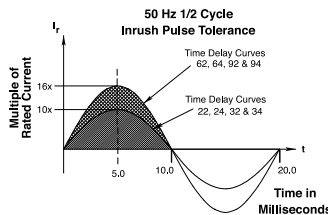
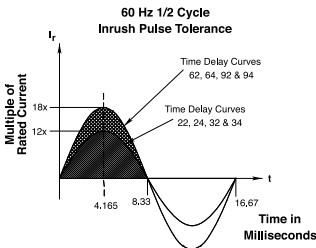

\*Manufacturer reserves the right to change product specification without prior notice.

Electrical Tables

**Table A:** Lists UL Recognized and CSA Accepted configurations & performance capabilities as a Component Supplementary Protector.

M-SERIES TABLE A: COMPONENT SUPPLEMENTARY PROTECTORS										
Circuit Configuration	Voltage			Current Rating		Poles Breaking	Short Circuit Capacity (Amps)		Application Codes	
	Max Rating	Frequency	Phase	Full Load Amps	General Purpose Amps		UL / CSA		UL	CSA
							With Backup Fuse	Without Backup Fuse		
Series	32	DC	---	0.02 - 15	---	1	---	1000	TC1, 2, OL1, U1	TC1, 2, OL1, U1
				---	15.1 - 25	1	---	1000	TC1, 2, OL0, U1	TC1, 2, OL0, U1
	50 <sup>2</sup>	DC	---	0.02 - 7.5	---	1	---	1000	TC1, 2, OL0, U1	TC1, 2, OL0, U1
				---	15.1 - 25	2	---	1000	TC1, 2, OL1, U1	TC1, 2, OL1, U1
	65	DC	---	0.02 - 15	---	2	---	1000	TC1, 2, OL0, U1	TC1, 2, OL0, U1
				---	15.1 - 25	2	---	1000	TC1, 2, OL1, U1	TC1, 2, OL1, U1
	65 <sup>1,2</sup>	DC	---	0.02 - 15	---	1	---	1000	TC1, 2, OL1, U1	TC1, 2, OL1, U1
				---	15.1 - 30	1	---	1000	TC1, 2, OL0, U1	TC1, 2, OL0, U1
	65	DC	---	0.02 - 15	---	2	5000 <sup>3</sup>	---	TC1, 2, OL1, C1	TC1, 2, OL1, C1
				---	15.1 - 25	2	5000 <sup>3</sup>	---	TC1, 2, OL0, C1	TC1, 2, OL0, C1
	80 <sup>1</sup>	DC	---	0.02 - 15	---	1	---	600	TC1, 2, OL1, U1	TC1, 2, OL1, U1
				---	15.1 - 30	1	---	600	TC1, 2, OL0, U1	TC1, 2, OL0, U1
	125	50 / 60	1	0.02 - 15	---	1	---	1000	TC1, 2, OL1, U1	TC1, 2, OL1, U1
				---	15.1 - 30	1	---	1000	TC1, 2, OL0, U1	TC1, 2, OL0, U1
				1 - 30	---	1	---	360	TC1, OL1, U2	TC3, OL1, U3
250 <sup>2</sup>	50 / 60	1	0.02 - 12	---	1	---	1000	TC1, 2, OL1, U1	TC1, 2, OL1, U1	
250	50 / 60	1	---	12.1 - 18	1	1000 <sup>4</sup>	---	TC1, 2, OL0, C1	TC1, 2, OL0, C1	
250	50 / 60	1	0.02 - 15	---	2	---	1000	TC1, 2, OL1, U1	TC1, 2, OL1, U1	
			---	15.1 - 30	2	---	1000	TC1, 2, OL0, U1	TC1, 2, OL0, U1	
			1 - 30	---	2	---	360	TC1, OL1, U2	TC3, OL1, U3	

- Notes:  
 1 Polarity Sensitive  
 2 Available only with Special Catalog Number. Consult Factory.  
 3 Requires Branch Circuit Backup with a UL Listed type K-5 or RK-5 fuse rated 30 Amps maximum  
 4 Requires Branch Circuit Backup with a UL Listed type K-5 or RK-5 fuse rated 60 Amps maximum

**Table B:** Lists UL Recognized, CSA Accepted and TUV and VDE Certified configurations and performance capabilities as a Component Supplementary Protector.

M-SERIES TABLE B: COMPONENT SUPPLEMENTARY PROTECTORS												
Circuit Configuration	Voltage			Current Rating		Poles Breaking	Short Circuit Capacity (Amps)				Application Codes	
	Max Rating	Frequency	Phase	Full Load Amps	General Purpose Amps		UL / CSA		VDE / TUV		UL	CSA
							With Backup Fuse	Without Backup Fuse	With Backup Fuse	Without Backup Fuse		
Series	32	DC	---	0.02 - 15	---	1	---	1000	3000	500	TC1, 2, OL1, U1	TC1, 2, OL1, U1
				---	15.1 - 25	1	---	1000	3000	500	TC1, 2, OL0, U1	TC1, 2, OL0, U1
	50 <sup>2</sup>	DC	---	0.02 - 7.5	---	1	---	1000	3000	500	TC1, 2, OL0, U1	TC1, 2, OL0, U1
				---	15.1 - 25	2	---	1000	3000	500	TC1, 2, OL1, U1	TC1, 2, OL1, U1
	65	DC	---	0.02 - 15	---	2	---	1000	3000	500	TC1, 2, OL0, U1	TC1, 2, OL0, U1
				---	15.1 - 25	2	---	1000	3000	500	TC1, 2, OL1, U1	TC1, 2, OL1, U1
	65 <sup>3</sup>	DC	---	0.02 - 15	---	2	5000	---	3000	500	TC1, 2, OL1, C1	TC1, 2, OL1, C1
				---	15.1 - 30	2	5000	---	3000	500	TC1, 2, OL0, C1	TC1, 2, OL0, C1
	80 <sup>1</sup>	DC	---	0.02 - 15	---	1	---	600 <sup>4</sup>	---	500	TC1, 2, OL1, U1	TC1, 2, OL1, U1
				---	15.1 - 30	1	---	600 <sup>4</sup>	---	500	TC1, 2, OL0, U1	TC1, 2, OL0, U1
	125	50 / 60	1	0.02 - 15	---	1	---	1000	3000	500	TC1, 2, OL1, U1	TC1, 2, OL1, U1
				1 - 15	---	1	---	360	3000	500	TC1, OL1, U2	TC3, OL1, U3
	250	50 / 60	1	0.02 - 12	---	1	---	1000	3000	500	TC1, 2, OL1, U1	TC1, 2, OL1, U1
				0.02 - 20	---	2	---	1000	3000	500	TC1, 2, OL0, U1	TC1, 2, OL0, U1
				1 - 12	---	1	---	360	3000	500	TC1, OL1, U2	TC3, OL1, U3

- Notes:  
 1 Polarity Sensitive  
 2 Available only with Special Catalog Number. Consult Factory.  
 3 Requires Branch Circuit Backup with a UL Listed type K-5 or RK-5 fuse rated 30 Amps maximum  
 4 TUV only, not VDE  
 5 Requires backup protection with a thermal magnetic circuit breaker rated 32 amps and having a Type C trip characteristic per EN60898/DIN VDE 0641 (C32A) for ratings greater than 15amps, and a thermal magnetic circuit breaker rated 16 amps and having a Type C trip characteristic per EN60898/DIN VDE 0641 (C16A) for ratings 15 amps and less

## Electrical Tables

**Table C:** Lists UL489A Listed and TUV Certified configurations and performance capabilities for use in Communications Equipment.

M-SERIES TABLE C: UL489A Listed (Communications Equipment - Polarity Sensitive)						
Circuit Configuration	Voltage		Current Rating General Purpose Amps	Poles Breaking	Interrupting Capacity (Amps)	
	Max Rating	Frequency			Without Backup Fuse	
					UL489A	TUV
Series	80	DC	0.02 - 30	1	600	---
	65 <sup>1</sup>	DC	0.02 - 30	1	1000	---
	80	DC	0.10 - 25	1	600	600

Notes:  
1. Available only with Special Catalog Number

**Table D:** Lists UL489A Listed configurations and performance capabilities for use in Communications Equipment.

M-SERIES TABLE D: Parallel Pole Construction UL489A Listed (Communications Equipment - Polarity Sensitive)						
Circuit Configuration	Voltage		Current Rating General Purpose Amps	Poles Breaking	Interrupting Capacity (Amps)	
	Max Rating	Frequency			Without Backup Fuse	
					UL489A	
Series	80	DC	31 - 50	2	600	
	65 <sup>1</sup>	DC	31 - 50	2	1000	

Notes:  
1. Available only with Special Catalog Number

## Agency Certifications

### UL Recognized

UL Standard 1077



Component Recognition Program as Protectors, Supplementary (Guide CCN/QVNU2, File E75596)

### CSA Accepted



Component Supplementary Protector (Class 3215 30, File 047848 0 000) CSA Standard C22.2 No. 235

### UL Listed

UL Standard 489A



Communications Equipment (Guide CCN/DITT, File E189195)

### VDE Certified



EN60934, VDE 0642 under File 10537

### TUV Certified



EN60934, under License No. R9671109





**1 SERIES**  
M

**2 ACTUATOR 1**

**Handle**  
M Paddle N Baton

**Push Button**  
T Push-Pull U Push To Reset

**Push Button with Snap-In Mounting**  
V Push-Pull W Push To Reset

**3 POLES**  
1 One 2 Two

**4 CIRCUIT 2**  
without Auxiliary Switch  
A Switch Only (no coil), Maintained Contacts  
B Series Trip (Current)  
with Auxiliary Switch, Silver Contacts Terminal Type:  
M Series Trip (Current) Aux Switch .110 QC x .020 QC  
P<sup>3</sup> Switch Only, Maintained Contacts .060 Dia, Round Solder Turret  
Q<sup>3,4</sup> Switch Only, Maintained Contacts .058 Dia, Round Q.C.  
R<sup>3,13</sup> Switch Only, Maintained Contacts .080 Dia x .020 Flat Q.C.  
S<sup>3</sup> Series Trip (Current) .060 Dia, Round Solder Turret  
T<sup>3,4</sup> Series Trip (Current) .058 Dia, Round Q.C.  
U<sup>3,13</sup> Series Trip, Maintained Contacts .080 Dia x .020 Flat Q.C.  
with Auxiliary Switch, Gold Contacts  
2<sup>3,4</sup> Switch Only, Maintained Contacts .058 Dia, Round Q.C.  
3<sup>3,13</sup> Switch Only, Maintained Contacts .080 Dia x .020 Flat Q.C.  
4<sup>3,4</sup> Series Trip (Current) .058 Dia, Round Q.C.  
5<sup>3,13</sup> Series Trip, Maintained Contacts .080 Dia x .020 Flat Q.C.  
9 Series Trip (Current) Aux Switch .110 QC x .020 QC

**5 FREQUENCY & DELAY**

03	DC 50/60Hz, Switch Only	32	DC, 50/60Hz Short
10	DC Instantaneous	34	DC, 50/60Hz Medium
12	DC Short	62	50/60Hz Short, Hi-Inrush
14	DC Medium	64	50/60Hz Medium, Hi-Inrush
20	50/60Hz Instantaneous	72	DC, Short, Hi-Inrush
22	50/60Hz Short	74	DC, Medium, Hi-Inrush
24	50/60Hz Medium	92	DC, 50/60Hz Short, Hi-Inrush
30	DC, 50/60Hz Instantaneous	94	DC, 50/60Hz Medium, Hi-Inrush

Voltage			Full Load Amp Rating		General Purpose Amps		Tungsten Lamp Rating		Poles Breaking
Max Rating	Frequency	Phase	Max Amps	Choose Current Coil Rating Code	Max Amps	Choose Current Coil Rating Code	Max Amps	Choose Current Coil Rating Code	
32	DC	-	15	615	25	625	-	-	1
50	DC	-	-	-	7.5	Consult Factory	-	-	1
65	DC	1	15	615	25	625	-	-	2
125	50/60Hz	1	15	615	25	625	15	615	1
250	50/60Hz	1	12	612	-	-	-	-	1
250	50/60Hz	1	15	615	25	625	-	-	2

- Notes:
- One actuator is located in the center of each multi-pole breaker. Actuator codes V & W limited to single pole breakers only.
  - Switch Only circuits are not available with Push-To-Reset actuators. For Switch Only circuits, select Current Coil Rating from the above chart.
  - One Auxiliary Switch is supplied per breaker. On two-pole breakers, standard Auxiliary Switch mounting is in pole one. Auxiliary Switch option limited to Series Trip and Switch Only circuits. Not available with back connect screw or push-in stud terminals.
  - Mates with AMP .058" diameter pin receptacles including 60983-1 (gold plated) and 60983-2 (tin plated).
  - Actuator color is only visible in the OFF position on Push-Pull actuators.
  - All units except snap-in mounting have one hex nut installed on bushing for use behind the panel.
  - Other colors available. Consult factory.
  - TUV and VDE Certification above 15 amps is for 2-pole only and is limited to a max. of 20 amps. Screw Terminal or Push-In Stud recommended above 20 amps.
  - 30 amp rating not available with delay's 30, 32, 34, 92 or 94.
  - Screw Terminals are VDE certified only with use of ring terminal attached to wire.
  - Terminal code A available with circuit codes A & B only.
  - Printed circuit board available with UL recognized approval only.
  - Auxiliary switch (flat Q.C.) available with UL recognized approvals only.

**6 CURRENT RATING (AMPERES) 8**

CODE	AMPERES						
020	0.020	225	0.250	420	2.000	710	10.500
025	0.025	230	0.300	522	2.250	611	11.000
030	0.030	235	0.350	425	2.500	711	11.500
035	0.035	240	0.400	527	2.750	612	12.000
040	0.040	245	0.450	430	3.000	712	12.500
045	0.045	250	0.500	435	3.500	613	13.000
050	0.050	255	0.550	440	4.000	614	14.000
055	0.055	260	0.600	445	4.500	615	15.000
060	0.060	265	0.650	450	5.000	616	16.000
065	0.065	270	0.700	455	5.500	617	17.000
070	0.070	275	0.750	460	6.000	618	18.000
075	0.075	280	0.800	465	6.500	620	20.000
080	0.080	285	0.850	470	7.000	622	22.000
085	0.085	290	0.900	475	7.500	624	24.000
090	0.090	295	0.950	480	8.000	625	25.000
090	0.095	410	1.000	485	8.500	630	30.000
210	0.100	512	1.250	490	9.000		
215	0.150	415	1.500	495	9.500		
220	0.200	517	1.750	610	10.000		

**7 TERMINAL 8**

1	Push-On 0.250 Tab (Q.C.)	A <sup>11</sup>	Push-In Stud
2 <sup>10</sup>	Screw 8-32 with Upturned Lugs	P <sup>12</sup>	Printed Circuit Board
3 <sup>10</sup>	Screw 8-32 (Bus Type)		

**8 ACTUATOR COLOR & LEGEND 5**

Gloss Handle	Push-Button	Actuator Color
1	A	White
2	B	Black
3	C	Red
4	D	Green
5	E	Blue
6	F	Yellow
8	H	Orange

**9 FRONT PANEL HARDWARE 6**

	Handle	Push-Button
No outer Panel Hardware	A	1
Knurled Nut		
Bright nickel	B	2
Bright nickel with locking ring	C	
Black	D	
Black with locking ring	E	
Panel Dress Nut		
Bright nickel	F	
Bright nickel with locking ring	G	
Black	H	
Black with locking ring	J	

**10 LEGEND PLATE / BUTTON MARKING**

**Handle Actuator Legend Plate (Actuator Styles M & N)**

- A No Legend Plate
- B ON - OFF Vertical
- C ON - OFF Horizontal
- D I - O Vertical
- E I - O Horizontal

**Push-Pull Actuator Button Cap (Actuator Styles T & V)**

- 1 No Marking
- 2 Rated Amps Horizontal
- 3 Rated Amps Line Side Down
- 4 Rated Amps Line Side Up

**Push-to-Reset Actuator Button (Actuator Styles U & W)**

- 1 No Marking

**11 BUSHING COLOR 7**  
B Black

**12 AGENCY APPROVAL 9**

- C UL Recognized & CSA Accepted
- D VDE Certified, UL Recognized & CSA Accepted
- E TUV Certified, UL Recognized & CSA Accepted

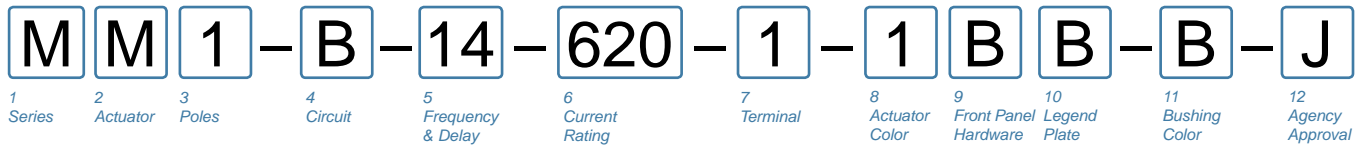

**1 SERIES**  
M

**2 ACTUATOR 1**

**Handle**  
M Paddle N Baton

**Push Button**  
T Push-Pull U<sup>8</sup> Push To Reset

**Push Button with Snap-In Mounting**  
V Push-Pull W<sup>8</sup> Push To Reset

**3 POLES**  
1 One

**4 CIRCUIT**

**without Auxiliary Switch**  
B Series Trip (Current)

**with Auxiliary Switch, Silver Contacts**  
M Series Trip (Current) Aux Switch  
S<sup>3</sup> Series Trip (Current)  
T<sup>3,4</sup> Series Trip (Current)  
U<sup>3,13</sup> Series Trip, Maintained Contacts

**with Auxiliary Switch, Gold Contacts**  
4<sup>2,3</sup> Series Trip (Current)  
5<sup>3,12</sup> Series Trip, Maintained Contacts  
9 Series Trip (Current) Aux Switch

**Terminal Type:**  
.110 QC x .020 QC  
.060 Dia, Round Solder Turret  
.058 Dia, Round Q.C.  
.080 Dia x .020 Flat Q.C.  
.058 Dia, Round Q.C.  
.080 Dia x .020 Flat Q.C.  
.110 QC x .020 QC

**5 FREQUENCY & DELAY**

10 DC Instantaneous	72 DC, Short, Hi-Inrush
12 DC Short	74 DC, Medium, Hi-Inrush
14 DC Medium	

**6 CURRENT RATING (AMPERES)**

CODE	AMPERES				
020	0.020	225	0.250	420	2.000
025	0.025	230	0.300	522	2.250
030	0.030	235	0.350	425	2.500
035	0.035	240	0.400	527	2.750
040	0.040	245	0.450	430	3.000
045	0.045	250	0.500	435	3.500
050	0.050	255	0.550	440	4.000
055	0.055	260	0.600	445	4.500
060	0.060	265	0.650	450	5.000
065	0.065	270	0.700	455	5.500
070	0.070	275	0.750	460	6.000
075	0.075	280	0.800	465	6.500
080	0.080	285	0.850	470	7.000
085	0.085	290	0.900	475	7.500
090	0.090	295	0.950	480	8.000
090	0.095	410	1.000	485	8.500
210	0.100	512	1.250	490	9.000
215	0.150	415	1.500	495	9.500
220	0.200	517	1.750	610	10.000

**7 TERMINAL 4**

1 Push-On 0.250 Tab (Q.C.)	A <sup>10</sup> Push-In Stud
2 Screw 8-32 with Upturned Lugs	P <sup>11</sup> Printed Circuit Board
3 Screw 8-32 (Bus Type)	

**8 ACTUATOR COLOR & LEGEND 5**

Gloss Handle	Push-Button	Actuator Color
1	A	White
2	B	Black
3	C	Red
4	D	Green
5	E	Blue
6	F	Yellow
8	H	Orange

**9 FRONT PANEL HARDWARE 6**

No outer Panel Hardware	Handle	Push-Button
<b>Knurled Nut</b>	A	1
Bright nickel	B	2
Bright nickel with locking ring	C	
Black	D	
Black with locking ring	E	
<b>Panel Dress Nut</b>	F	
Bright nickel	G	
Bright nickel with locking ring	H	
Black	J	
Black with locking ring		

**10 LEGEND PLATE / BUTTON MARKING**

**Handle Actuator Legend Plate (Actuator Styles M & N)**

A No Legend Plate  
B ON - OFF Vertical  
C ON - OFF Horizontal  
D I - O Vertical  
E I - O Horizontal

**Push-Pull Actuator Button Cap (Actuator Styles T & V)**

1<sup>8</sup> No Marking  
2 Rated Amps Horizontal  
3 Rated Amps Line Side Down  
4 Rated Amps Line Side Up

**Push-to-Reset Actuator Button (Actuator Styles U & W)**

1<sup>8</sup> No Marking

**11 BUSHING COLOR 7**

B Black

**12 AGENCY APPROVAL 9**

J UL489A Listed, TUV Certified  
M UL Recognized, CSA Accepted  
N UL Recognized, TUV Certified  
T UL489A Listed

1 One actuator is located in the center of each multi-pole breaker. Actuator codes V & W limited to single pole breakers only.  
2 One Auxiliary Switch is supplied per breaker. On two-pole breakers, standard Auxiliary Switch mounting is in pole one. Auxiliary Switch option limited to Series Trip and Switch Only circuits. Not available with Back Connected Screw or Push-in Stud terminals.  
3 Mates with AMP .058" diameter pin receptacles including 60983-1 (gold plated) and 60983-3 (tin plated).  
4 Screw terminals or Push-in Stud recommended above 20 amps.  
5 Actuator color is only visible in the OFF position on Push-Pull actuators.  
6 All units have one hex nut installed on bushing for use behind the panel.  
7 Other colors available. Consult factory.  
8 Not available with UL489A Listed breakers.  
9 TUV certified to 25 amps. UL Recognized, CSA Accepted and UL Listed to 30 amps.  
10 Terminal code A available with circuit codes A & B only.  
11 Printed circuit board available with UL recognized approval only.  
12 Auxiliary switch (flat Q.C.) available with UL recognized approvals only.

# Circuit & Terminal Diagrams: in. [mm]

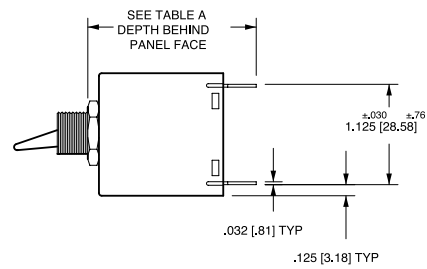
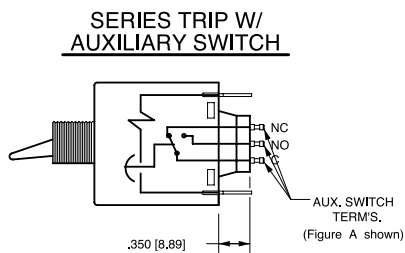
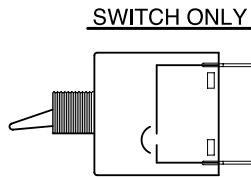
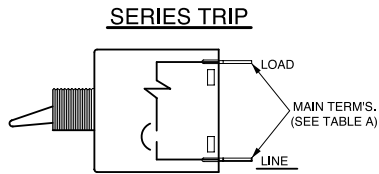

TERMINAL DESCRIPTION		DEPTH BEHIND PANEL FACE *
MAIN	TAB (Q.C.)	1.890 [48.00]
	SCREW (#8-32)	1.930 [49.03]
	PUSH-IN STUD	2.520 [64.00]
AUX. **	DOUBLE SOLDER TURRET TYPE	2.035 [51.69]
	ROUND Q.C. TYPE	2.025 [51.44]
	FLAT QUICK-CONNECT	2.129 [54.08]
	FLAT SOLDER LUG	2.012 [51.10]

\*DEPTH INCLUDES BEHIND PANEL HEX NUT AS SUPPLIED ON ALL UNITS.

\*\*WHEN CALLED FOR ON MULTI-POLE UNITS, ONLY ONE AUX. SWITCH IS NORMALLY SUPPLIED, MOUNTED AS SHOWN IN FIG. A

## MULTI-POLE IDENTIFICATION SCHEME

SOLDER TURRET AND ROUND QC AUX SWITCH TERMINALS

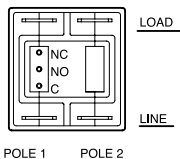

FIG. A

FLAT QC AND SOLDER LUG AUX SWITCH TERMINALS

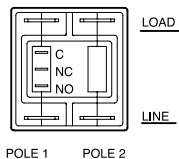
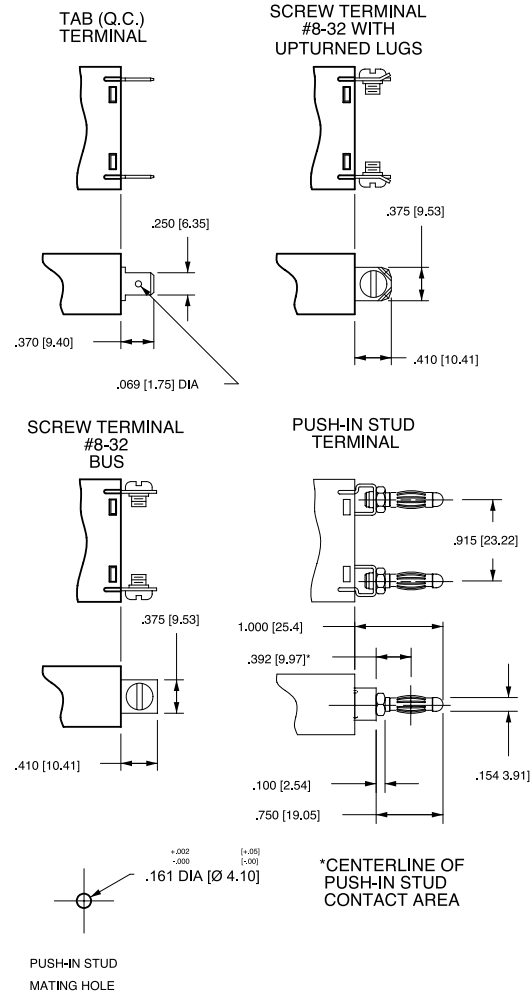

FIG. B

## TERMINAL DIMENSIONAL DETAIL



\*CENTERLINE OF PUSH-IN STUD CONTACT AREA

## AUXILIARY SWITCH TERMINALS

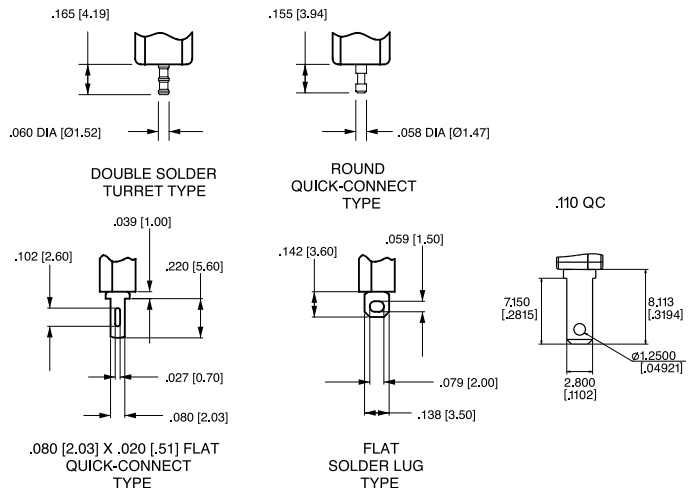

\*AVAILABLE THROUGH SPECIAL CATALOG PART NUMBER

- Notes:  
 1 All dimensions are in inches [millimeters].  
 2 Tolerance ±.020 [.51] unless otherwise specified.

## PC Terminal Diagrams: in. [mm]

### HANDLE TYPE SHOWN WITHOUT AUX. SWITCH

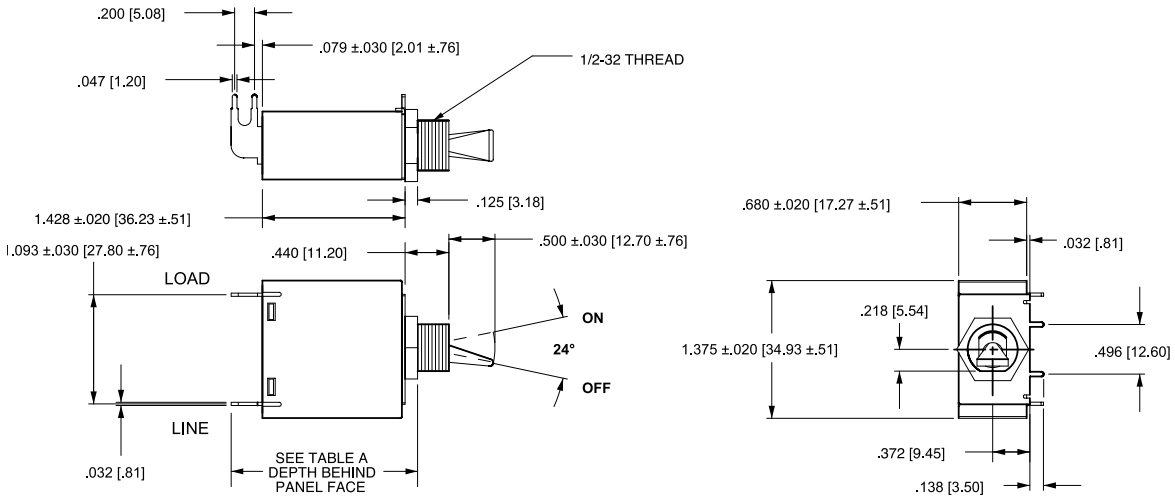

### P.C. FOOTPRINT

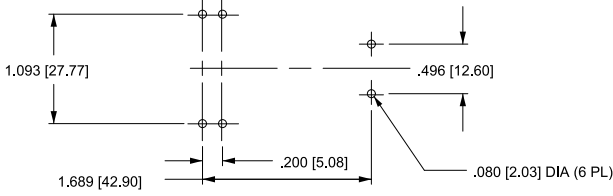

### P.C. TERMINAL

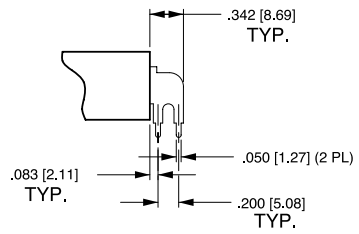

### HANDLE TYPE SHOWN WITH AUX. SWITCH

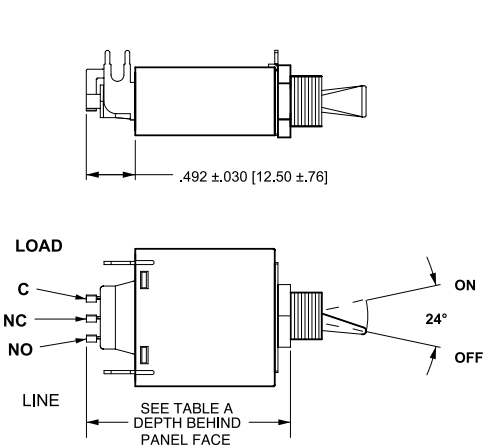

### PANEL HARDWARE

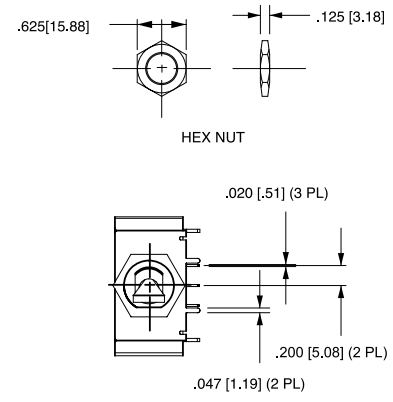

### P.C. FOOTPRINT

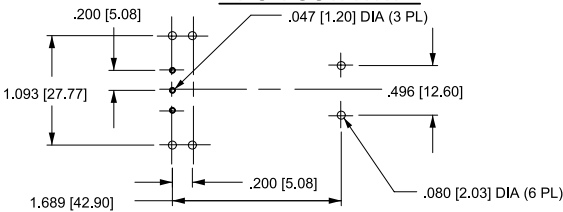

TABLE A		
TERMINAL DESCRIPTION		DEPTH BEHIND PANEL FACE *
MAIN	PRINTED CIRCUIT BOARD	1.957 [49.71]
AUX. SWITCH	PRINTED CIRCUIT BOARD	2.449 [62.20]

\*DEPTH INCLUDES BEHIND PANEL HEX NUT AS SUPPLIED ON ALL UNITS

Notes:  
 1 All dimensions are in inches [millimeters].  
 2 Tolerance ±.020 [.51] unless otherwise specified.

## Dimensional Specifications: in. [mm]

### PADDLE ACTUATOR STYLE

#### SINGLE POLE

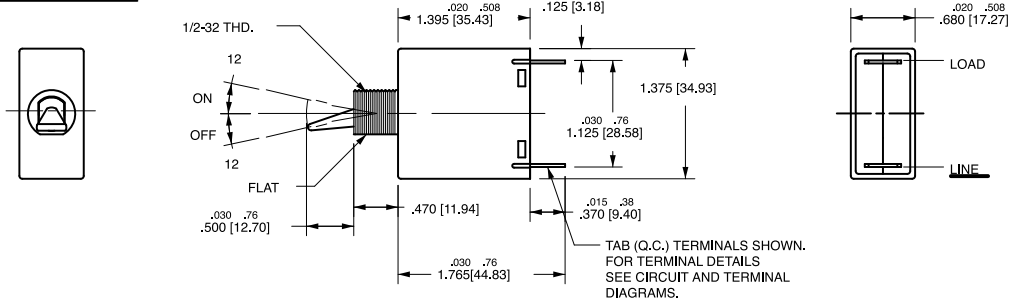

#### DOUBLE POLE

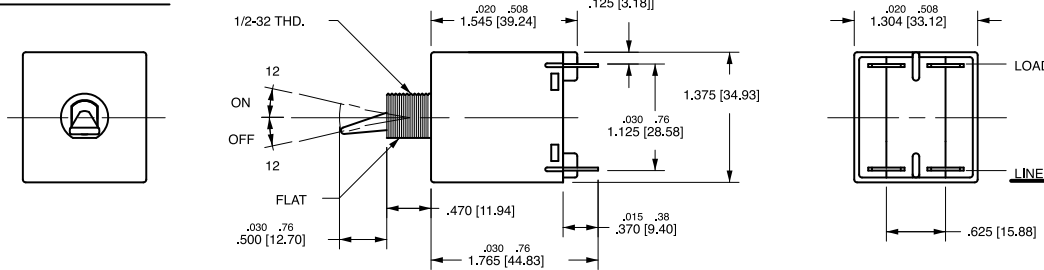

### BATON ACTUATOR STYLE

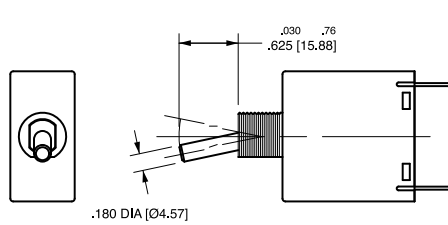

### MOUNTING DETAILS

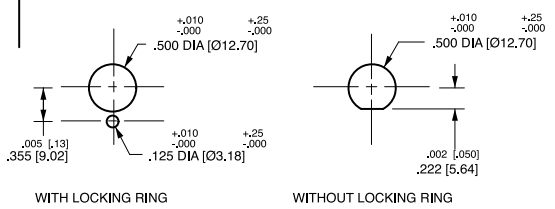

### LEGEND PLATES

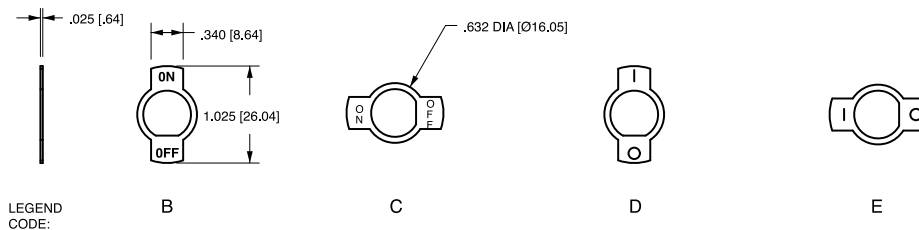

### PANEL HARDWARE

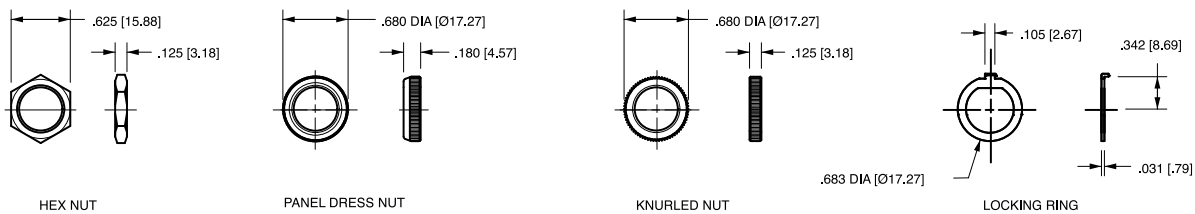

Notes:  
 1 All dimensions are in inches [millimeters].  
 2 Tolerance  $\pm 0.020$  [.51] unless otherwise specified.

# Circuit & Terminal Diagrams: in. [mm]

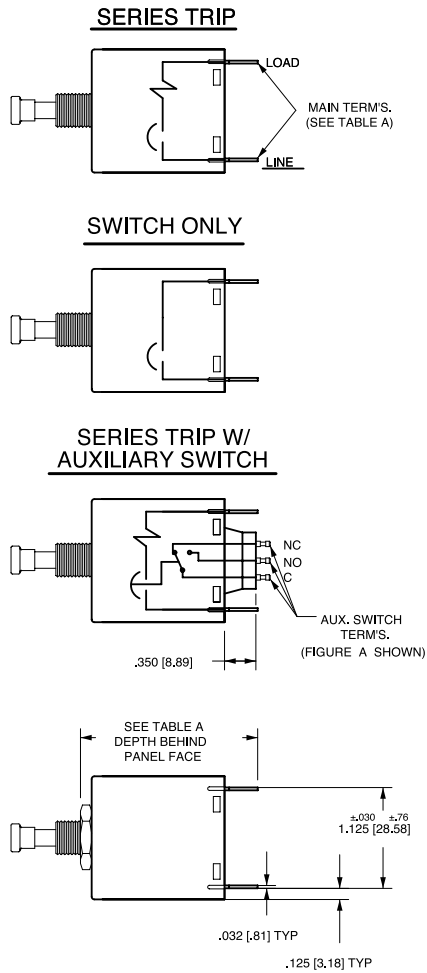

TABLE A		
TERMINAL DESCRIPTION		DEPTH BEHIND PANEL FACE *
MAIN	TAB (Q.C.)	1.952 [49.57]
	SCREW (#8-32)	1.992 [50.60]
	PUSH-IN STUD	2.582 [65.58]
AUX. ** SWITCH	DOUBLE SOLDER TURRET TYPE	2.097 [53.26]
	ROUND Q.C TYPE	2.087 [53.01]
	FLAT QUICK-CONNECT	2.191 [55.65]
	FLAT SOLDER LUG	2.074 [52.68]

\*DEPTH INCLUDES BEHIND PANEL HEX NUT AS SUPPLIED ON ALL UNITS.

\*\* WHEN CALLED FOR ON MULTI-POLE UNITS, ONLY ONE AUX. SWITCH IS NORMALLY SUPPLIED, MOUNTED AS SHOWN IN FIG. A

## MULTI-POLE IDENTIFICATION SCHEME

SOLDER TURRET AND ROUND QC AUX SWITCH TERMINALS

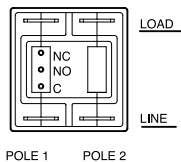

FIG. A

FLAT QC AND SOLDER LUG AUX SWITCH TERMINALS

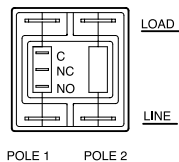
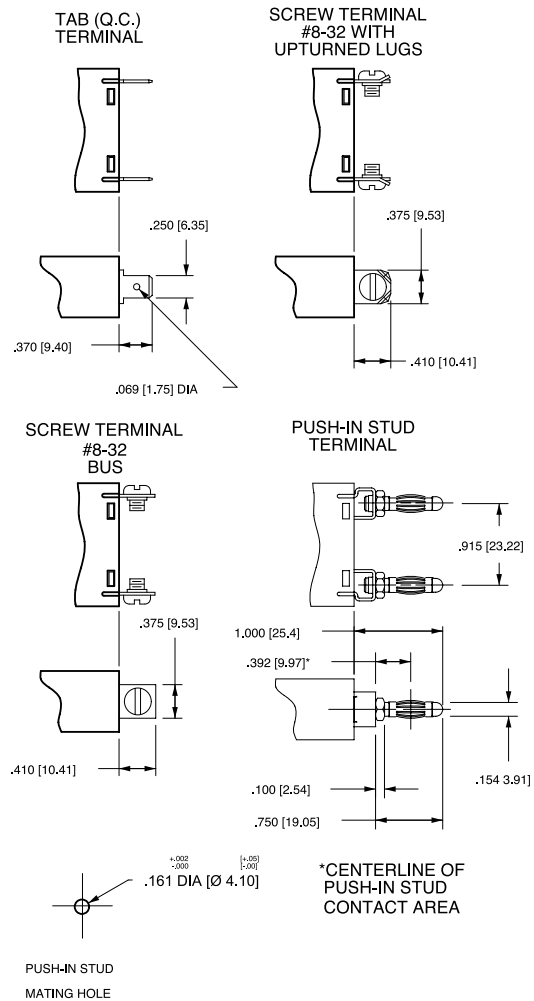
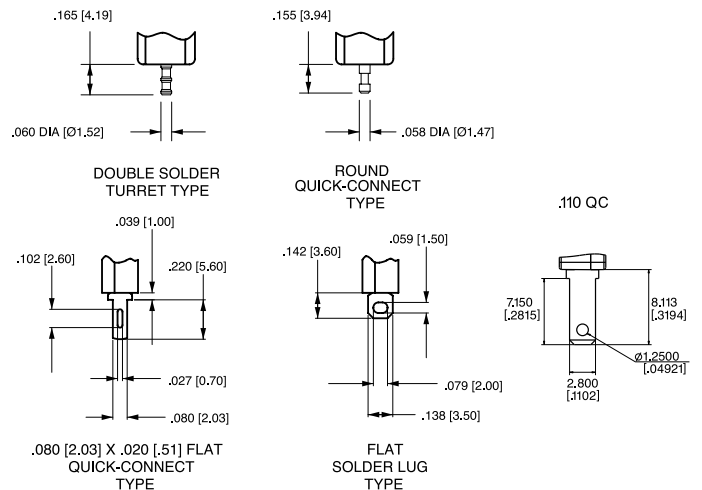

FIG. B

## TERMINAL DIMENSIONAL DETAIL



## AUXILIARY SWITCH TERMINALS



\*AVAILABLE THROUGH SPECIAL CATALOG PART NUMBER

Notes:

- 1 All dimensions are in inches [millimeters].
- 2 Tolerance  $\pm .020$  [.51] unless otherwise specified.

## Dimensional Specifications: in. [mm]

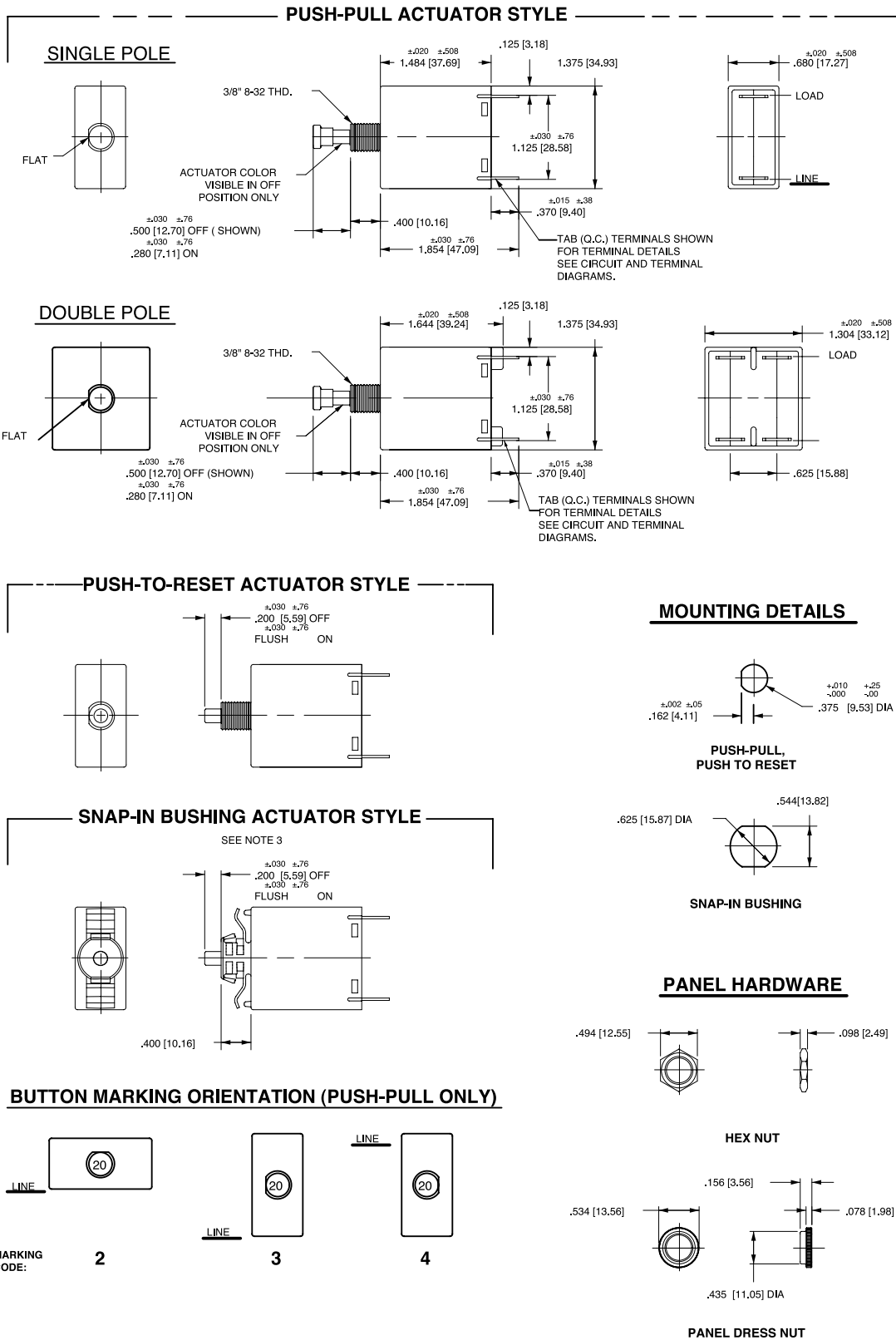

Notes:

- 1 All dimensions are in inches [millimeters].
- 2 Tolerance ± 0.20 [5.1] unless otherwise specified.
- 3 Available with Push-Pull or Push-to-Reset Actuators

## PC Terminal Diagrams: in. [mm]

### PUSH-PULLTYPE SHOWN WITHOUT AUX. SWITCH

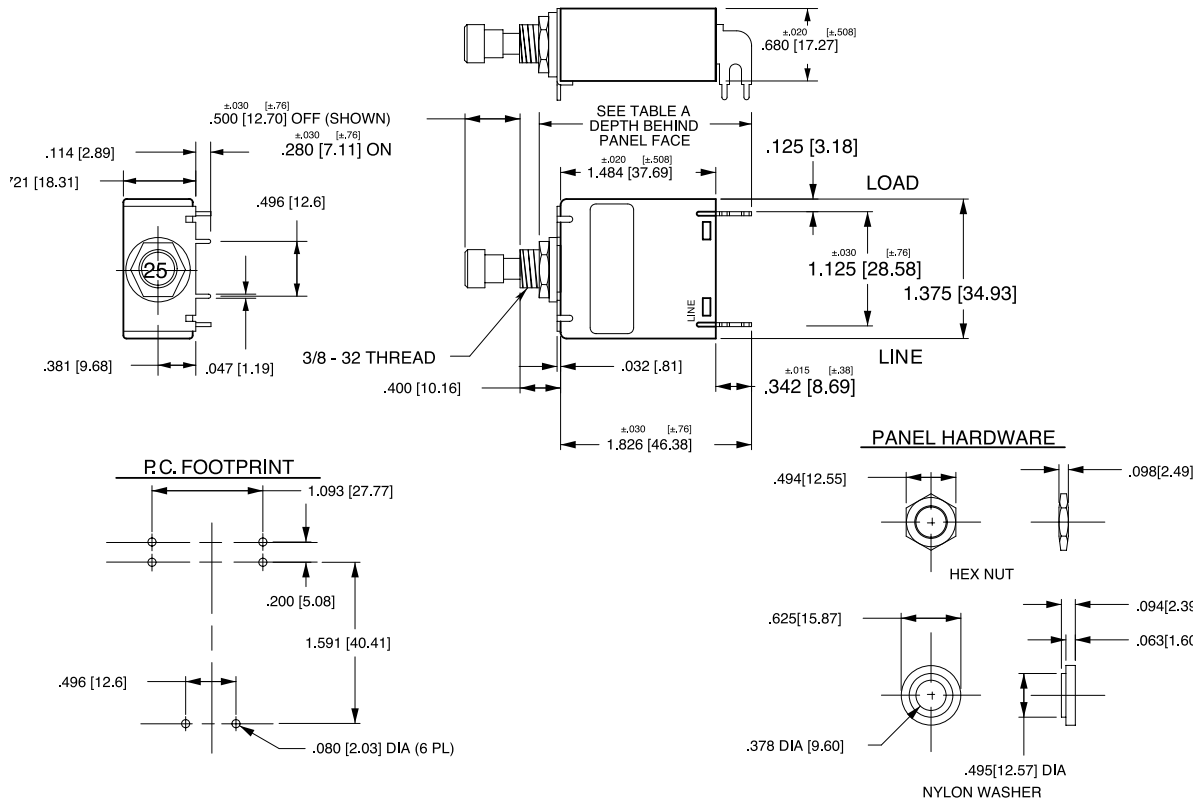

### PUSH-PULL TYPE SHOWN WITH AUX. SWITCH

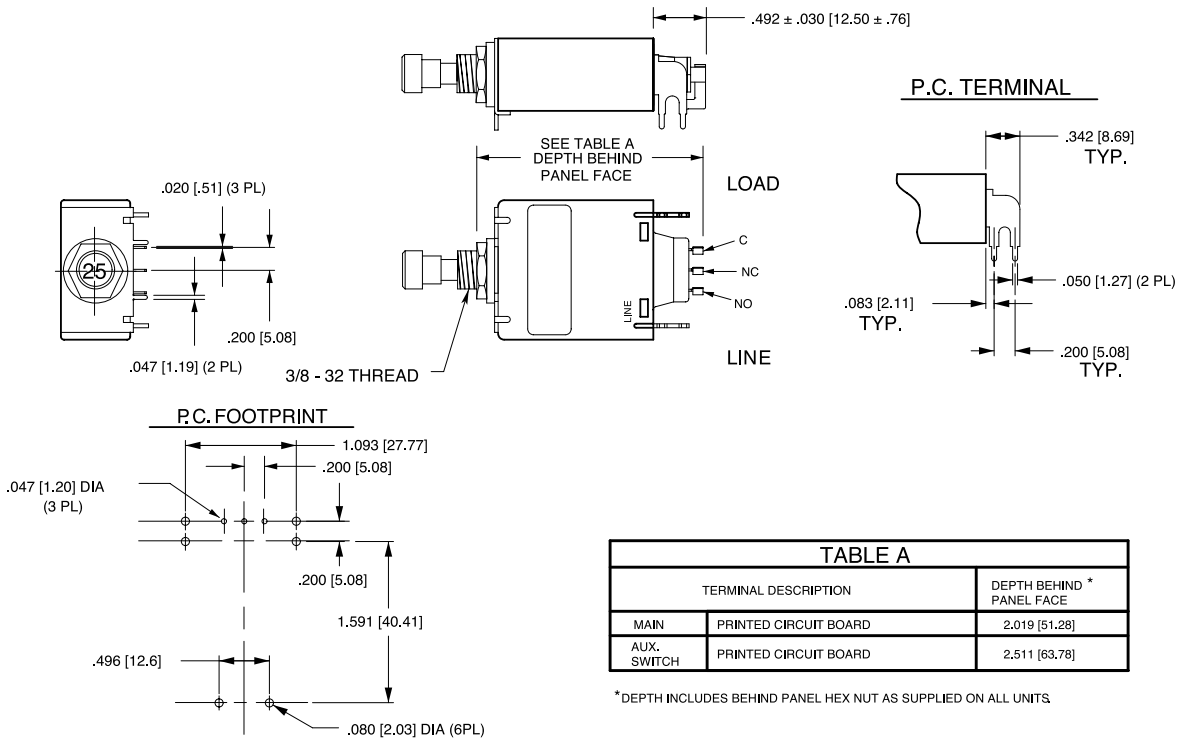

- Notes:
- 1 All dimensions are in inches [millimeters].
  - 2 Tolerance  $\pm 0.020$  [.51] unless otherwise specified.



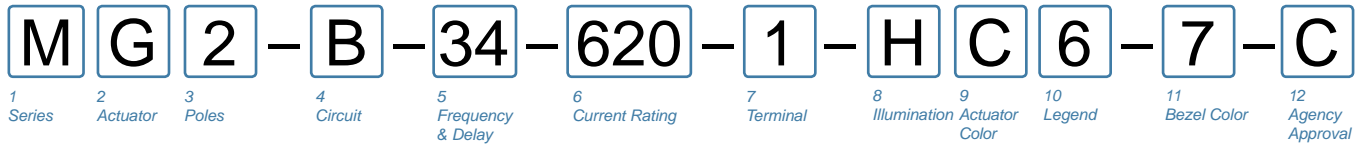

**1 SERIES**  
M

**2 ACTUATOR 1**  
**Non-Illuminated single color**  
**Two Color Visi-Rocker illuminated single color**  
**Angled D Indicate ON F Angled**  
**Flat E Indicate OFF G Flat**

STYLE	INDICATE "ON" (CODES B & G)	INDICATE "OFF" (CODES E & H)	FLAT (CODES B & G)	ANGLED (CODES E & H)
VERTICAL				
HORIZONTAL				

**3 POLES**  
 1 One                      2 Two

**4 CIRCUIT 2**  
**without Auxiliary Switch**  
**A** Switch Only (no coil), Maintained Contacts  
**B** Series Trip (Current)  
**with Auxiliary Switch, Silver Contacts Terminal Type:**  
**M** Series Trip (Current) Aux Switch .110 QC x .020 QC  
**P** 3 Switch Only, Maintained Contacts .060 Dia, Round Solder Turret  
**Q** 3,4 Switch Only, Maintained Contacts .058 Dia, Round Q.C.  
**R** 3,16 Switch Only, Maintained Contacts .080 Dia x .020 Flat Q.C.  
**S** 3 Series Trip (Current) .060 Dia, Round Solder Turret  
**T** 3,4 Series Trip (Current) .058 Dia, Round Q.C.  
**U** 3,16 Series Trip, Maintained Contacts .080 Dia x .020 Flat Q.C.  
**with Auxiliary Switch, Gold Contacts**  
**2** 3,4 Switch Only, Maintained Contacts .058 Dia, Round Q.C.  
**3** 3,16 Switch Only, Maintained Contacts .080 Dia x .020 Flat Q.C.  
**4** 3,4 Series Trip (Current) .058 Dia, Round Q.C.  
**5** 3,16 Series Trip, Maintained Contacts .080 Dia x .020 Flat Q.C.  
**9** Series Trip (Current) Aux Switch .110 QC x .020 QC

**5 FREQUENCY & DELAY**

<b>03</b> DC 50/60Hz, Switch Only	<b>32</b> DC, 50/60Hz Short
<b>10</b> DC Instantaneous	<b>34</b> DC, 50/60Hz Medium
<b>12</b> DC Short	<b>62</b> 50/60Hz Short, Hi-Inrush
<b>14</b> DC Medium	<b>64</b> 50/60Hz Medium, Hi-Inrush
<b>20</b> 50/60Hz Instantaneous	<b>72</b> DC, Short, Hi-Inrush
<b>22</b> 50/60Hz Short	<b>74</b> DC, Medium, Hi-Inrush
<b>24</b> 50/60Hz Medium	<b>92</b> DC, 50/60Hz Short, Hi-Inrush
<b>30</b> DC, 50/60Hz Instantaneous	<b>94</b> DC, 50/60Hz Medium, Hi-Inrush

VOLTAGE			FULL LOAD AMP RATING		GENERAL PURPOSE AMP RATING		TUNGSTEN LAMP RATING		POLES BREAKING
MAX. RATING	FREQUENCY	PHASE	MAX. AMPS	CHOOSE CURRENT COIL RATING CODE:	MAX. AMPS	CHOOSE CURRENT COIL RATING CODE:	MAX. AMPS	CHOOSE CURRENT COIL RATING CODE:	
32	DC	-	15	615	25	625	-	-	1
50	DC	-	-	-	7.5	Consult Factory	-	-	1
65	DC	-	15	615	25	625	-	-	2
125	50/60HZ	1	15	615	25	625	15	615	1
250	50/60HZ	1	12	612	-	-	-	-	1
250	50/60HZ	1	15	615	25	625	-	-	2

- Notes:
- One actuator is located in the center of each multi-pole breaker.
  - For Switch Only circuits, select Current Coil Rating from the above chart.
  - One Auxiliary Switch is supplied per breaker. On two-pole breakers, standard Auxiliary Switch mounting is in pole one. Auxiliary Switch option limited to Series Trip & Switch Only circuits, & is not available in single pole illuminated breakers, or Back Connected Screw or Push-in Stud terminals.
  - Mates with AMP .058" diameter pin receptacles: 60983-1 (gold plated) & 60983-2 (tin plated).
  - For neon bulb applications at 120VAC @ 47K, 1/4 WATT and for 250VAC applications @ 150K, 1/4 WATT, external resistors must be supplied by customer.
  - On Visi-Rocker breakers, Visi portion of rocker cannot be the same color as the bezel.
  - For LED (DC or rectified AC) applications, LED is mounted in the center of the rocker actuator with electrical characteristics: 100 millicandela at 20mA; Maximum power dissipation = 75mW at 25°C; Maximum forward current = 25mA; Typical forward voltage = 2.1V at 20mA; Typical reverse current = 100uA at 3V. Customer supplies the proper external resistor limiting current to these values.
  - Rocker color for LED's and green neon lamp must be clear, smoke gray, white translucent or match color of LED or neon lamp.
  - Other colors available. Consult factory.
  - TUV 20A, VDE 15A. UL Recognized and CSA Accepted to 30 amps. Screw Terminals or Push-in Stud recommended above 20 amps.
  - TUV or VDE Certified must have I-O or Dual Legends. Legend required on Visi-Rocker breakers.
  - 30 amp rating not available with delay's 30, 32, 34, 92 or 94.
  - Screw Terminals are VDE certified only with use of ring terminal attached to wire.
  - Terminal code A available with circuit codes A & B only.
  - Printed circuit board available with UL recognized approval only.
  - Auxiliary switch (flat Q.C.) available with UL recognized approvals only.

**6 CURRENT RATING (AMPERES)**

CODE	AMPERES						
020	0.020	225	0.250	420	2.000	710	10.500
025	0.025	230	0.300	522	2.250	611	11.000
030	0.030	235	0.350	425	2.500	711	11.500
035	0.035	240	0.400	527	2.750	612	12.000
040	0.040	245	0.450	430	3.000	712	12.500
045	0.045	250	0.500	435	3.500	613	13.000
050	0.050	255	0.550	440	4.000	614	14.000
055	0.055	260	0.600	445	4.500	615	15.000
060	0.060	265	0.650	450	5.000	616	16.000
065	0.065	270	0.700	455	5.500	617	17.000
070	0.070	275	0.750	460	6.000	618	18.000
075	0.075	280	0.800	465	6.500	620	20.000
080	0.080	285	0.850	470	7.000	622	22.000
085	0.085	290	0.900	475	7.500	624	24.000
090	0.090	295	0.950	480	8.000	625	25.000
090	0.095	410	1.000	485	8.500	630 <sup>12</sup>	30.000
210	0.100	512	1.250	490	9.000		
215	0.150	415	1.500	495	9.500		
220	0.200	517	1.750	610	10.000		

**7 TERMINAL**

1	Push-On 0.250 Tab (Q.C.)	A <sup>14</sup>	Push-In Stud
2	10 Screw 8-32 with Upturned Lugs	P <sup>15</sup>	Printed Circuit Board
3	10 Screw 8-32 (Bus Type)		

**8 ROCKER ILLUMINATION**  
**Non-illuminated**  
**Neon** 5  
 without resistor, 120VAC/250VAC  
**LED** 7, 8  
 without resistor  
 with resistor, 4-8 VDC  
 with resistor, 9-16 VDC

<b>A</b> Neon	Green Glow	<b>B</b>	Amber
<b>C</b> Neon	Green	<b>D</b>	K
<b>E</b> Neon	Amber	<b>F</b>	L
<b>G</b> Neon	White	<b>H</b>	M
<b>I</b> Neon	Black	<b>J</b>	

**9 ACTUATOR & LEGEND COLOR**

**Solid Color**

1	White	Legend
2	Black	Black
3	Red	White
4	Green	White
5	Blue	White
6	Yellow	Black
7	Gray	Black
8	Orange	Black

**Visi-Rocker** 6  
 Visi & Legend (remainder of rocker same color as bezel)

1	White	
2	Black	
3	Red	
4	Green	
5	Blue	
6	Yellow	
7	Gray	
8	Orange	

**Illuminated** 8  
 Actuator

<b>A</b>	Clear	Legend
<b>B</b>	Red Transparent	White
<b>C</b>	Green Transparent	White
<b>D</b>	Amber Transparent	White
<b>E</b>	Smoke Gray Transparent	White
<b>F</b>	White Translucent	Black

**10 LEGEND 11**

1	No Legend	4	I - O Vertical
2	ON - OFF Vertical	5	I - O Horizontal
3	ON - OFF Horizontal	6	Dual Vertical
		7	Dual Horizontal

**11 BEZEL COLOR / STYLE 9**

Color	without Rockerguard	with Rockerguard
White	A	1
Black	B	2
Gray	G	7

**12 AGENCY APPROVAL 10**

<b>C</b>	UL Recognized & CSA Accepted
<b>D</b>	VDE Certified, UL Recognized & CSA Accepted
<b>E</b>	TUV Certified, UL Recognized & CSA Accepted

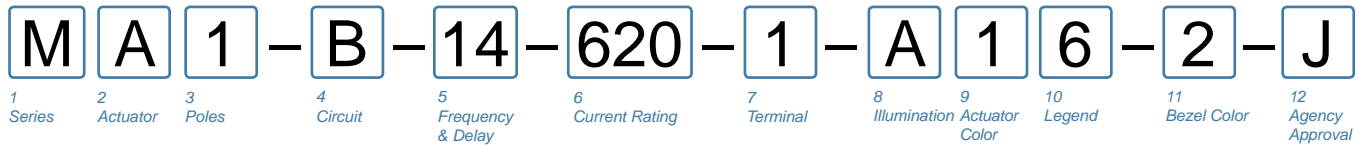

**1 SERIES**  
M

**2 ACTUATOR 1**  
**Non-Illuminated single color**  
**A** Angled  
**B** Flat  
**Two Color Visi-Rocker**  
**D** Indicate ON  
**E** Indicate OFF  
**Illuminated single color**  
**F** Angled  
**G** Flat

STYLE	INDICATE "ON" (00080)	INDICATE "OFF" (00082)	FLAT (00084 & 0)	ANGLED (00084 & 1)
VERTICAL				
HORIZONTAL				

**3 POLES**  
1 One

**4 CIRCUIT 2**  
**without Auxiliary Switch**  
**B** Series Trip (Current)  
**with Auxiliary Switch, Silver Contacts** **Terminal Type:**  
**M** Series Trip (Current) Aux Switch .110 QC x .020 QC  
**S** 3 Series Trip (Current) .060 Dia, Round Solder Turret  
**T** 3,4 Series Trip (Current) .058 Dia, Round Q.C.  
**U** 3,16 Series Trip, Maintained Contacts .080 Dia x .020 Flat Q.C.  
**with Auxiliary Switch, Gold Contacts**  
**4** 3,4 Series Trip (Current) .058 Dia, Round Q.C.  
**5** 3,16 Series Trip, Maintained Contacts .080 Dia x .020 Flat Q.C.  
**9** Series Trip (Current) Aux Switch .110 QC x .020 QC

**5 FREQUENCY & DELAY**  
**10** DC Instantaneous **14** DC Medium  
**12** DC Short **72** DC, Short, Hi-Inrush  
**74** DC, Medium, Hi-Inrush

**6 CURRENT RATING (AMPERES)**

CODE	AMPERES						
020	0.020	225	0.250	420	2.000	710	10.500
025	0.025	230	0.300	522	2.250	611	11.000
030	0.030	235	0.350	425	2.500	711	11.500
035	0.035	240	0.400	527	2.750	612	12.000
040	0.040	245	0.450	430	3.000	712	12.500
045	0.045	250	0.500	435	3.500	613	13.000
050	0.050	255	0.550	440	4.000	614	14.000
055	0.055	260	0.600	445	4.500	615	15.000
060	0.060	265	0.650	450	5.000	616	16.000
065	0.065	270	0.700	455	5.500	617	17.000
070	0.070	275	0.750	460	6.000	618	18.000
075	0.075	280	0.800	465	6.500	620	20.000
080	0.080	285	0.850	470	7.000	622	22.000
085	0.085	290	0.900	475	7.500	624	24.000
090	0.090	295	0.950	480	8.000	625	25.000
090	0.095	410	1.000	485	8.500	630	30.000
210	0.100	512	1.250	490	9.000		
215	0.150	415	1.500	495	9.500		
220	0.200	517	1.750	610	10.000		

- Notes:
- One actuator is located in the center of each multi-pole breaker.
  - One Auxiliary Switch is supplied per breaker. Auxiliary Switch option limited to Series Trip & Switch Only circuits, and is not available in single pole illuminated breakers, or with Back Connected Screw or Push-in Stud terminals.
  - Mates with AMP .058" diameter pin receptacles: 60983-1 (gold plated) & 60983-1 (tin plated).
  - For neon bulb applications at 120VAC @ 47K, 1/4 WATT and for 250VAC applications @ 150K, 1/4 WATT, external resistors must be supplied by customer.
  - For LED (DC or rectified AC) applications, LED is mounted in the center of the rocker actuator with electrical characteristics as follows: 100 millicandela at 20mA; Maximum power dissipation = 75mW at 25°C; Maximum forward current = 25mA; Typical forward voltage = 2.1V at 20mA; Typical reverse current = 100uA at 3V. Customer supplies the proper external resistor limiting current to these values.
  - On Visi-Rocker breakers, Visi portion of rocker cannot be the same color as the bezel.
  - Rocker color for LED's and green neon lamp must be clear, smoke gray, white translucent or match color of LED or neon lamp.
  - Other colors available. Consult factory.
  - TUV Certified to 25 amps. UL Recognized, CSA Accepted and UL489A Listed to 30 amps. Screw Terminals recommended above 20 amps.
  - UL489A Listed must have ON-OFF or Dual legends. TUV Certified approvals must have I - O or Dual legends.
  - Terminal code A available with circuit codes A & B only.
  - Printed circuit board available with UL recognized approval only.
  - Auxiliary switch (flat Q.C.) available with UL recognized approvals only.

**7 TERMINAL**  
**1** Push-On 0.250 Tab (Q.C.) **A** 11 Push-In Stud  
**2** Screw 8-32 with Upturned Lugs **P** 12 Printed Circuit Board  
**3** Screw 8-32 (Bus Type)

**8 ROCKER ILLUMINATION**  
**Non-Illuminated Neon** 4  
 without resistor, 120VAC/250VAC **A** Neon Green Glow 8  
**LED** 7, 8 **B** Red Green Amber  
 without resistor **D** G K  
 with resistor, 4-8 VDC **E** H L  
 with resistor, 9-16 VDC **F** J M

**9 ACTUATOR & LEGEND COLOR**  
**Solid Color**  
**1** White Legend Black  
**2** Black Legend White  
**3** Red Legend White  
**4** Green Legend White  
**5** Blue Legend White  
**6** Yellow Legend Black  
**7** Gray Legend Black  
**8** Orange Legend Black  
**Visi-Rocker** 6 Visi & Legend (remainder of rocker same color as bezel)  
**1** White  
**2** Black  
**3** Red  
**4** Green  
**5** Blue  
**6** Yellow  
**7** Gray  
**8** Orange  
**Illuminated** 7 Actuator Legend  
**A** Clear White  
**B** Red Transparent White  
**C** Green Transparent White  
**D** Amber Transparent White  
**E** Smoke Gray Transparent White  
**F** White Translucent Black

**10 LEGEND 10**  
**1** No Legend (Single Color or Illuminated Rocker Options Only)  
**2** ON - OFF Vertical  
**3** ON - OFF Horizontal  
**4** I - O Vertical  
**5** I - O Horizontal  
**6** Dual Vertical  
**7** Dual Horizontal

**11 BEZEL COLOR / STYLE 8**  
**Color** without Rockerguard with Rockerguard  
 White **A** 1  
 Black **B** 2  
 Gray **G** 7

**12 AGENCY APPROVAL 9**  
**J** UL489A Listed & TUV Certified  
**M** UL Recognized & CSA Accepted  
**N** TUV Certified, UL Recognized & CSA Accepted  
**T** UL489A Listed

## Circuit & Terminal Diagrams: in. [mm]

### SERIES TRIP

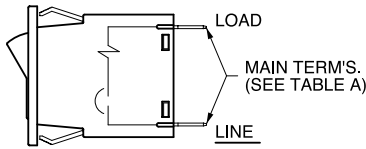

### SERIES TRIP W/ ILLUMINATED ROCKER

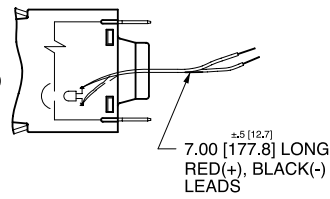

### SWITCH ONLY

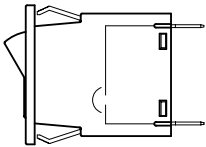

### SWITCH ONLY W/ ILLUMINATED ROCKER

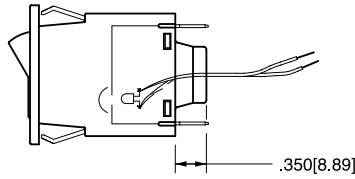

### SERIES TRIP W/ AUXILIARY SWITCH

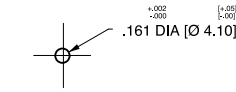
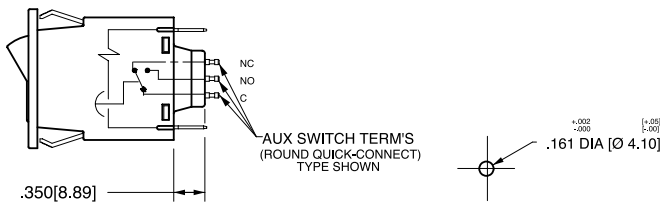

PUSH-IN STUD MATING HOLE

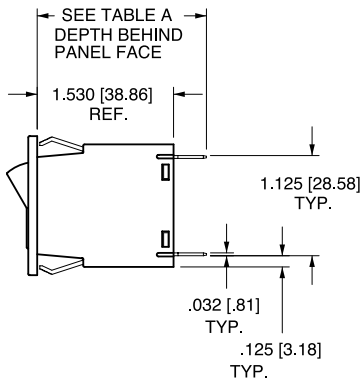

### TERMINAL DIMENSIONAL DETAIL

#### TAB (Q.C.) TERMINAL

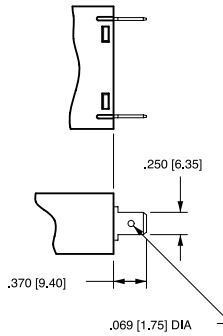

#### SCREW TERMINAL #8-32 WITH UPTURNED LUGS

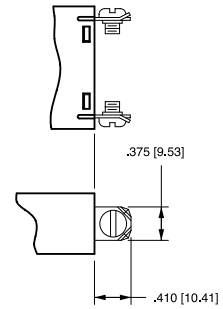

#### SCREW TERMINAL #8-32 BUS

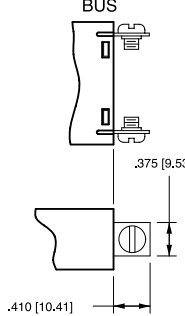

#### PUSH-IN STUD TERMINAL

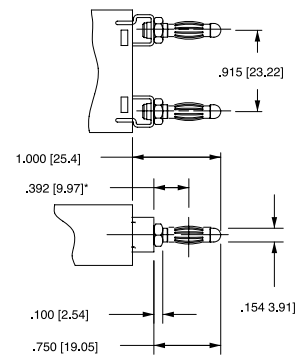

\*CENTERLINE OF PUSH-IN STUD CONTACT AREA

### AUXILIARY SWITCH TERMINALS

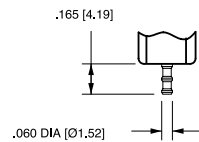

#### DOUBLE SOLDER TURRET TYPE

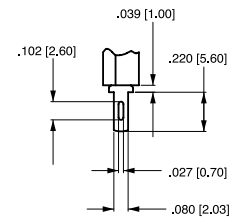

.080 [2.03] X .020 [.51] FLAT QUICK-CONNECT TYPE

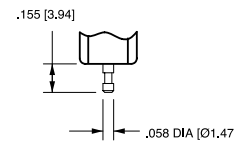

#### ROUND QUICK-CONNECT TYPE

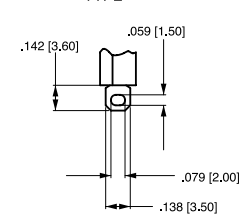

FLAT SOLDER LUG TYPE

\*AVAILABLE THROUGH SPECIAL CATALOG PART NUMBER

#### .110 QC

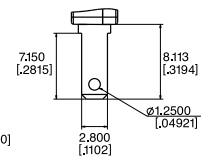

TABLE - A		
TERMINAL DESCRIPTION		DEPTH BEHIND PANEL FACE
MAIN	TAB (Q.C.)	1.900 [48.26]
	SCREW (#8-32)**	1.940 [49.28]
	PUSH-IN STUD	2.530 [64.26]
* AUX. SWITCH	DOUBLE SOLDER TURRET TYPE	2.045 [51.94]
	ROUND Q.C. TYPE	2.035 [51.69]
	FLAT QUICK CONNECT	2.139 [54.33]
	FLAT SOLDER LUG	2.022 [51.36]

\* AUX. SWITCH IS NOT AVAILABLE ON SINGLE POLE ILLUMINATED UNITS. WHEN CALLED FOR ON MULTI-POLE UNITS, ONLY ONE AUX. SWITCH IS NORMALLY SUPPLIED, MOUNTED AS SHOWN ON CLA-8003.

\*\* RECOMMENDED TIGHTENING TORQUE 12-15 IN LBS [1.4-2.7 NM]

Notes:

- All dimensions are in inches [millimeters].
- Tolerance  $\pm 0.020$  [.51] unless otherwise specified.
- Schematic shown represents current trip circuit.

## Dimensional Specifications: in. [mm]

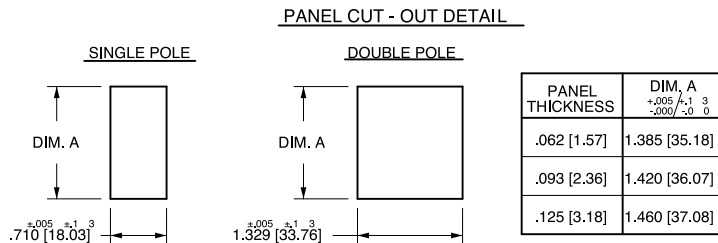
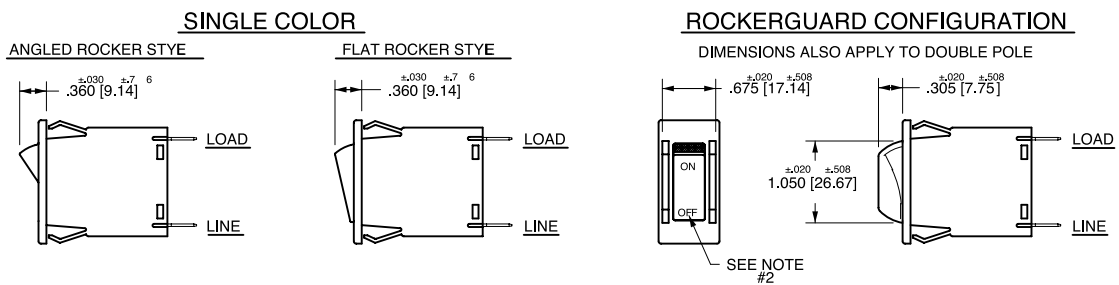
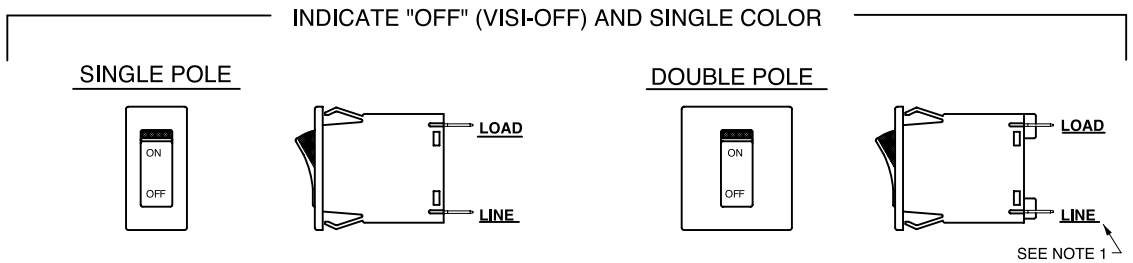
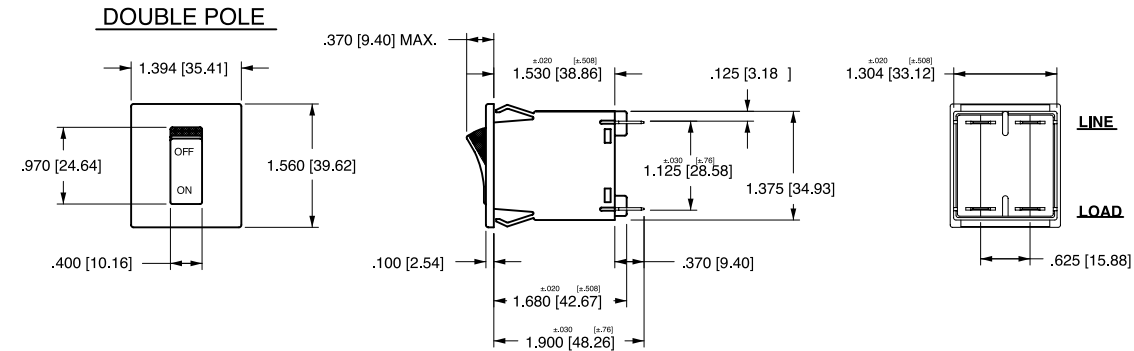
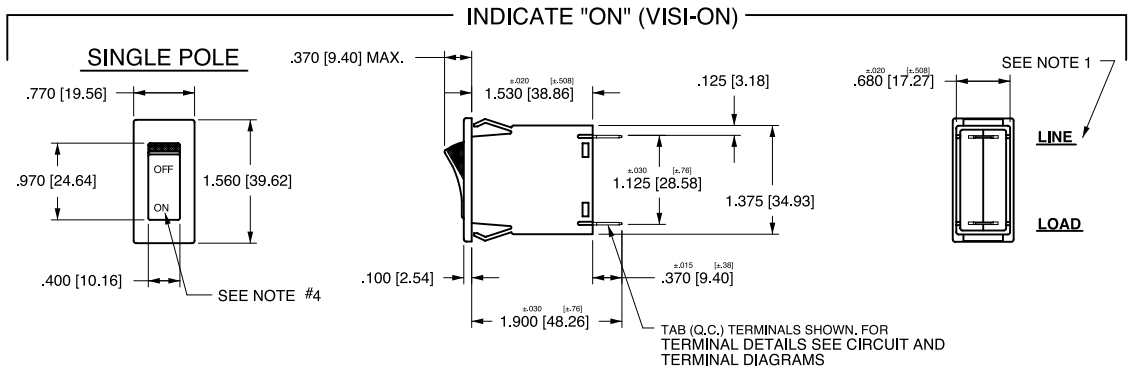

**Notes:**

- Dimensions apply to all variations shown. Notice that circuit breaker line & load terminal orientation on indicate OFF is opposite of indicate ON.
- I-O, ON-OFF or dual legends available for vertical or horizontal mounting. For pole orientation with horizontal legend, rotate front view clockwise 90°.
- All dimensions are in inches [millimeters].
- Tolerance ± 0.20 [51] unless otherwise specified.

**ONE POLE**

**SINGLE POLE / ROCKER BREAKERS SHOWN WITH DOUBLE SOLDER TURRET AND ROUND QC AUX. SWITCH TERMINALS**

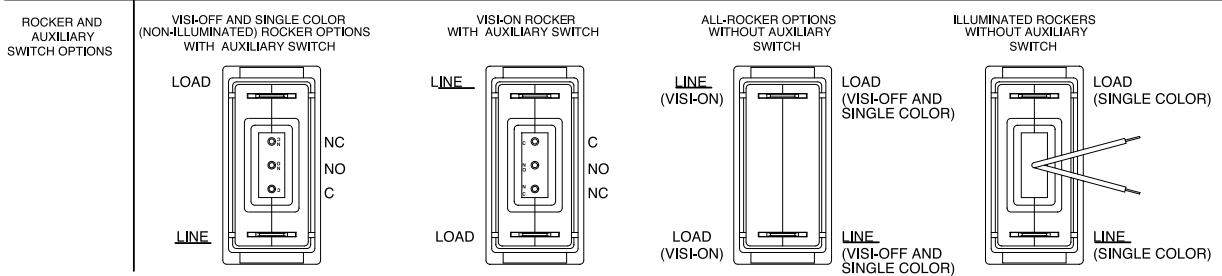

**SINGLE POLE / ROCKER BREAKERS SHOWN WITH FLAT QC AND FLAT SOLDER LUG AUX. SWITCH TERMINALS**

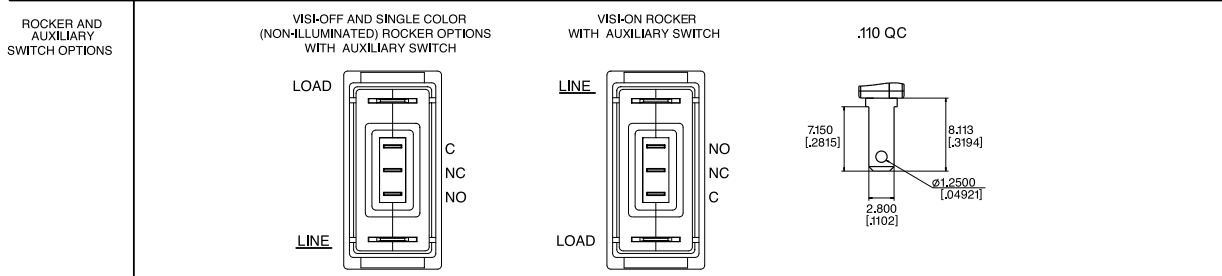

**TWO POLE**

**DOUBLE POLE / ROCKER BREAKERS SHOWN WITH DOUBLE SOLDER TURRET AND ROUND QC AUX. SWITCH TERMINALS**

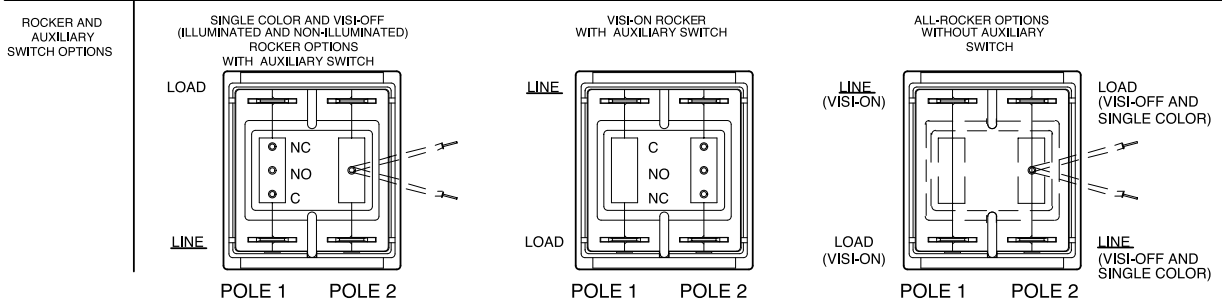

**DOUBLE POLE / ROCKER BREAKERS SHOWN WITH FLAT QC AND FLAT SOLDER LUG AUX. SWITCH TERMINALS**

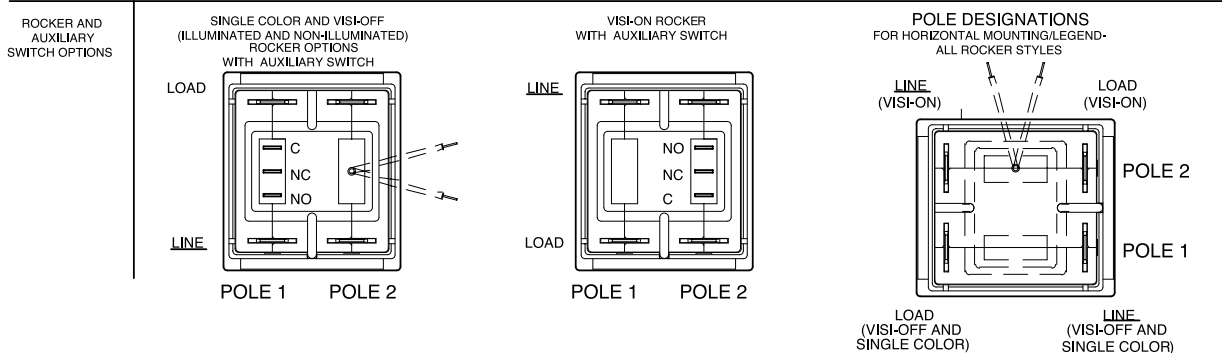

# A-Series

## CIRCUIT BREAKER

Well known for their proven reliability, Carling Technologies' A-Series hydraulic magnetic circuit breakers are compact, temperature stable and designed for precision operation in OEM markets requiring general purpose as well as full load amp applications. When front panel operation and aesthetics demand a clean, contemporary design, the visi-rocker or paddle actuators are ideally suitable. A sealed toggle actuator style is also available and ideal for harsh environment applications requiring additional sealing protection. Optional rocker-guard and push-to-reset bezels, which help prevent inadvertent actuation, are also available.

1-6 poles; ratings from 0.02 to 50 amps, up to 277VAC or 80VDC; UL Recognized, UL Listed, UL1500, UL1077, TUV, VDE & CSA



### Product Highlights:

- Up to 50 amps in a compact size
- Various actuator styles
- Sealed metal toggle option tested to MIL-PRF-55629C. Meets IP68 Requirements

Only Marine applicable ordering schemes and drawings are shown in this catalog. For complete product details, please visit [www.carlingtech.com](http://www.carlingtech.com)

**Electrical**

Maximum Voltage 277VAC 50/60 Hz, 80VDC  
 Current Ratings Standard current coils: 0.100, 0.250, 0.500, 0.750, 1.00, 2.50, 5.00, 7.50, 10.0, 15.0, 20.0, 25.0, 30.0, 35.0, 40.0, 50.0. Other ratings available - consult ordering scheme.  
 Standard Voltage Coils DC-6V, 12V; AC-120V, Other ratings available, consult ordering scheme.  
 Auxiliary Switch Rating SPDT; 10.1 A - 250VAC, 1.0 A-65VDC/0.5 A - 80 VDC, 0.1A - 125VAC (with gold contacts).  
 Insulation Resistance Minimum: 100 Megohms at 500 VDC  
 Dielectric Strength UL, CSA - 1500V 60 Hz for one minute between all electrically isolated terminals. A-Series rocker circuit breakers comply with the 8mm spacing & 3750V dielectric requirements from hazardous voltage to operator accessible surfaces per EN 60950 and VDE 0805.  
 Resistance, Impedance Values from Line to Load Terminal - based on Series Trip Circuit Breaker.

**Mechanical**

Endurance 10,000 ON-OFF operations @ 6 per minute; with rated Current & Voltage. All A-Series Circuit Breakers will trip on overload, even when the actuator is forcibly held in the ON position.  
 Trip Free The operating actuator moves positively to the OFF position when an overload causes the circuit breaker to trip. When mid-trip handle is specified, the handle moves to the mid position on electrical trip of the circuit breaker. When mid-trip handle with alarm switch is specified, the handle moves to the mid position & the alarm switch actuates when the circuit breaker is electrically tripped.

**Physical**

Number of Poles 1 - 6 Poles (handle) and 1-3 poles (rocker) at 30 Amps or less. 1 and 2 poles at 31 Amps thru 50 Amps.  
 Internal Circuit Config. Series, (with or without auxiliary switch), Shunt and Relay with current or voltage trip coils, Dual Coil, Switch Only with or without auxiliary switch.  
 Weight Approximately 65 grams/pole. (Approximately 2.32 ounces/pole)  
 Standard Colors Housing - Black; Actuator- See Ordering Scheme.

**Environmental**

Designed and tested in accordance with requirements of specification MIL-PRF-55629 & MIL-STD-202 as follows:  
 Shock Withstands 100 Gs, 6ms, sawtooth while carrying rated current per Method 213, Test Condition "I". Instantaneous and ultra-short curves tested @ 90% of rated current.  
 Vibration Withstands 0.060" excursion from 10-55 Hz, and 10 Gs 55-500 Hz, at rated current per Method 204C, Test Condition A. Instantaneous and ultrashort curves tested at 90% of rated current.  
 Moisture Resistance Method 106D; ten 24-hour cycles @ + 25°C to +65°C, 80-98% RH.56 days @ +85°C, 85% RH.  
 Salt Spray Method 101, Condition A (90-95% RH @ 5% NaCl Solution, 96 hrs).  
 Thermal Shock Method 107D, Condition A (Five cycles @ -55°C to +25°C to +85°C to +25°C).  
 Operating Temperature -40° C to +85° C

RESISTANCE PER POLE VALUES from Line to Load Terminals (Values Based on Series Trip Circuit Breaker)

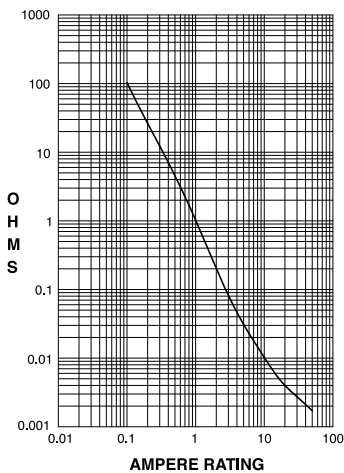

CURRENT (AMPS)	TOLERANCE (%)
0.10 - 5.0	15
5.1 - 20.0	25
20.1 - 50.0	35

**Pulse Tolerance Curves**

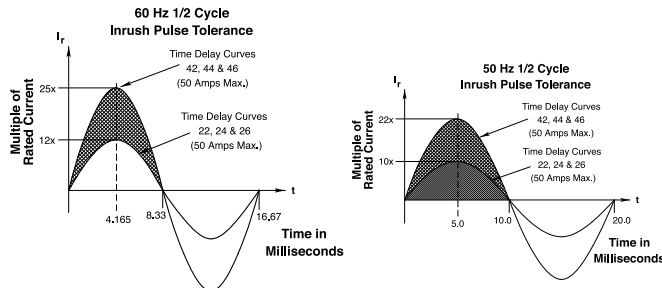

\*Manufacturer reserves the right to change product specification without prior notice.

## Electrical Tables

**Table A:** Lists UL Recognized & CSA Accepted configurations and performance capabilities as a Component Supplementary Protector.

A-SERIES TABLE A: COMPONENT SUPPLEMENTARY PROTECTORS											
Circuit Configuration	Voltage			Current Rating		Short Circuit Capacity (Amps)		Application Codes		Construction Notes	
	Max Rating	Frequency	Phase	Full Load Amps	General Purpose Amps	UL / CSA		UL	CSA		
						With Backup Fuse	Without Backup Fuse				
Series	32	DC	---	0.02 - 15	---	---	5000	TC1, OL1, U2	TC1, OL1, U2		
	65	DC	---	31 - 50	---	---	7500	TC1, 2, OL1, U1	TC1, 2, OL1, U1		
	80	DC	---	0.02 - 30	---	---	7500	TC1, 2, OL1, U1	TC1, 2, OL1, U1		
				---	31 - 50	---	7500	TC1, 2, OLO, U1	TC1, 2, OLO, U1		
	125	50 / 60	1	0.02 - 30	---	---	3000	TC1, OL1, U2	TC1, OL1, U2	Rocker Version	
	125	50 / 60	1	1 - 50	---	---	2000	TC1, OL1, U2	TC1, OL1, U2		
	125	50 / 60	1 <sup>4</sup>	1 - 50	---	---	1000	TC1, OL1, U2	TC3, OL1, U3		
	125 / 250	50 / 60	1 <sup>3</sup>	0.02 - 30	---	---	3000	TC1, 2, OL1, U2	TC1, 2, OL1, U2	Rocker Version	
	125 / 250	50 / 60	1 <sup>3</sup>	0.02 - 50	---	---	3000	TC1, 2, OL1, U2	TC1, 2, OL1, U2	Handle	
	250	50 / 60	1	0.02 - 30	---	---	1500	TC1, 2, OLO, U2	TC1, 2, OLO, U2	Single Pole Break	
				0.02 - 30	---	---	3000	TC1, OL1, U2	TC1, OL1, U2	Two Pole Break	
				---	---	---	3000	TC1, 2, OLO, U1	TC1, 2, OLO, U1		
				1 <sup>4</sup>	1 - 50	---	1000	TC1, OL1, U2	TC3, OL1, U3		
	3	0.02 - 30	---	5000 <sup>2</sup>	---	---	---	TC1, 2, OL1, C1	TC1, 2, OL1, C1		
31 - 50											---
277	50 / 60	1	0.02 - 30	---	---	5000 <sup>1</sup>	---	TC1, 2, OL1, C1	TC1, 2, OL1, C1		
Dual Coil	32	DC	---	0.02 - 50	---	---	5000	TC1, OL1, U2	TC1, OL1, U2		
	65	DC	---	0.02 - 50	---	---	7500	TC1, 2, OL1, U1	TC1, 2, OL1, U1		
	80	DC	---	0.02 - 30	---	---	7500	TC1, 2, OL1, U1	TC1, 2, OL1, U1		
				---	31 - 50	---	7500	TC1, 2, OLO, U1	TC1, 2, OLO, U1		
	125	50 / 60	1	0.02 - 30	---	---	3000	TC1, OL1, U2	TC1, OL1, U2	Rocker Version	
				1 - 50	---	---	2000	TC1, OL1, U2	TC1, OL1, U2		
	125	50 / 60	1 <sup>4</sup>	0.02 - 30	---	---	1000	TC1, OL1, U2	TC3, OL1, U3		
	125 / 250	50 / 60	1 <sup>3</sup>	0.02 - 30	---	---	3000	TC1, 2, OL1, U1	TC1, 2, OL1, U1	Rocker Version	
	125 / 250	50 / 60	1 <sup>3</sup>	0.02 - 50	---	---	3000	TC1, 2, OL1, U2	TC1, 2, OL1, U2		
	250	50 / 60	1	0.02 - 30	---	---	1500	TC1, OLO, U2	TC1, OLO, U2	Single Pole Break	
				0.02 - 30	---	---	3000	TC1, OL1, U2	TC1, OL1, U2	Two Pole Break	
				---	31 - 50	---	3000	TC1, 2, OLO, U1	TC1, 2, OLO, U1		
				1 <sup>4</sup>	1 - 50	---	1000	TC1, OL1, U2	TC3, OL1, U3		
	3	0.02 - 30	---	5000 <sup>2</sup>	---	---	---	TC1, 2, OL1, C1	TC1, 2, OL1, C1		
31 - 50											---
277	50 / 60	1	0.02 - 30	---	---	5000 <sup>1</sup>	---	TC1, 2, OL1, U1	TC1, 2, OL1, U1		
Shunt	80	DC	---	0.02 - 30	---	---	7500	TC1, 2, OL1, U1	TC1, 2, OL1, U1		
	125 / 250	50 / 60	1	0.02 - 30	---	---	3000	TC1, 2, OL1, U1	TC1, 2, OL1, U1		
				0.02 - 30	---	---	3000	TC1, 2, OL1, U1	TC1, 2, OL1, U1		
	250	50 / 60	3	0.02 - 30	---	---	5000 <sup>2</sup>	---	TC1, 2, OL1, C1	TC1, 2, OL1, C1	
				0.02 - 30	---	---	5000 <sup>2</sup>	---	---	---	---
277	50 / 60	1	0.02 - 30	---	---	5000 <sup>1</sup>	---	TC1, 2, OL1, C1	TC1, 2, OL1, C1		
Relay	80	DC	---	0.02 - 30	---	---	7500	TC1, 2, OL1, U1	TC1, 2, OL1, U1		
	125 / 250	50 / 60	1 <sup>3</sup>	0.02 - 30	---	---	3000	TC1, 2, OL1, U1	TC1, 2, OL1, U1		
				0.02 - 30	---	---	3000	TC1, 2, OL1, U1	TC1, 2, OL1, U1		
	250	50 / 60	3	0.02 - 30	---	---	5000 <sup>2</sup>	---	TC1, 2, OL1, C1	TC1, 2, OL1, C1	
				0.02 - 30	---	---	5000 <sup>2</sup>	---	---	---	---
277	50 / 60	1	0.02 - 30	---	---	5000 <sup>1</sup>	---	TC1, 2, OL1, C1	TC1, 2, OL1, C1		
Switch Only	65	DC	---	0.02 - 50	---	not applicable					
	80	DC	---	0.02 - 30	---	not applicable					
	250	50 / 60	1	---	31 - 50	not applicable					
				3	0.02 - 50	not applicable					
	277	50 / 60	1	0.02 - 30	31 - 50	not applicable					

Notes:  
 1 Requires branch circuit backup with a UL LISTED Type K5 or RK5 fuse (15A minimum) at no more than 4 times the rating of the protector.  
 2 Same as note 1, except that backup fuse is limited to 80 A maximum.  
 3 2 pole protector required (with one pole per power line) for: 125/250 VAC, 1 pole protector required for: 125 VAC, 1Ø Power System.  
 4 Satisfies the requirements of clause 11.2.8.2.5 of CSA STD C22.2 No 100 for the use of supplementary protectors with portable generators.



Electrical Tables

**Table B:** Lists UL Recognized, CSA Accepted, VDE & TUV Certified configurations & performance capabilities as a Component Supplementary Protector.

A-SERIES TABLE B: COMPONENT SUPPLEMENTARY PROTECTORS															
CIRCUIT CONFIGURATION	VOLTAGE			CURRENT RATING		SHORT CIRCUIT CAPACITY (AMPS)						APPLICATION CODES		VDE CONSTRUCTION NOTES	
	MAX. RATING	FREQUENCY	PHASE	FULL LOAD AMPS	GENERAL PURPOSE AMPS <sup>1</sup>	UL/CSA		VDE		TUV		UL	CSA		
						WITH BACKUP FUSE	WITHOUT BACKUP FUSE	(Inc) WITH BACKUP FUSE	(Inc) WITHOUT BACKUP FUSE	(Inc) WITH BACKUP FUSE	(Inc) WITHOUT BACKUP FUSE				
SERIES	65	DC	—	0.10 - 50	—	—	7500	—	—	5000	3000	TC1,2, OL1,U1	TC1,2, OL1,U1	World Market Breaker TUV Only	
	80	DC	—	0.10 - 30	—	—	7500	3000	1500	3000	1500	TC1,2, OL1,U1	TC1,2, OL1,U1	Handle Version 1 Pole Only	
				31 - 50	31 - 50	—	7500	3000	1500	3000	1500	TC1,2, OL0,U1	TC1,2, OL0,U1	Handle Version 1 Pole Only	
				0.10 - 30	—	—	7500	3000	1500	3000	1500	TC1,2, OL1,U1	TC1,2, OL1,U1	Rocker Version 1 - 3 Poles	
				31 - 32	—	—	7500	3000	1500	3000	1500	TC1,2, OL1,U1	TC1,2, OL1,U1	Rocker Version 2 Pole Only	
				31 - 50	31 - 50	—	7500	3000	1500	3000	1500	TC1,2, OL0,U1	TC1,2, OL0,U1	Rocker Version 1 Pole Only	
	250	50 / 60	1	0.10 - 30	—	—	3000	3000	1500	5000	1500	TC1,2, OL1,U1	TC1,2, OL1,U1	Rocker Version 1 - 3 Poles	
				31 - 50	31 - 50	—	3000	—	—	5000	1500	TC1,2, OL0,U1	TC1,2, OL0,U1	Rocker Version 1 - 3 Poles	
				31 - 32	—	—	3000	6000	1500	5000	1500	TC1,2, OL1,U1	TC1,2, OL1,U1	Rocker Version 2 Pole Only	
				0.10 - 30	—	—	3000	6000	1500	5000	1500	TC1, OL1,U2	TC1, OL1,U2	Rocker Version 2 Pole Only	
			1 <sup>4</sup>	1 - 50	—	—	1000	—	—	5000	1500	TC1, OL1,U2	TC3, OL1,U3	Rocker Version 1 - 3 Poles	
			3	0.10 - 30	—	—	5000 <sup>3</sup>	—	3000	1500	3000	1500	TC1,2, OL1,C1	TC1,2, OL1,C1	Rocker Version 1 - 3 Poles
				31 - 50	—	—	2000 <sup>2</sup>	—	3000	1500	3000	1500	TC1,2, OL1,C1	TC1,2, OL1,C1	Rocker Version 1 - 3 Poles
				0.10 - 30	—	—	—	—	—	3000	1500	TC1,2, OL1,C1	TC1,2, OL1,C1	Rocker Version 1 - 3 Poles	
DUAL COIL	80	DC	—	0.10 - 30	—	—	7500	3000	1500	3000	1500	TC1,2, OL1,U1	TC1,2, OL1,U1	Rocker Version 1 - 3 Poles	
	250	50 / 60	1	0.10 - 30	—	—	3000	3000	1500	5000	1500	TC1,2, OL1,U1	TC1,2, OL1,U1	Rocker Version 1 - 3 Poles	
				30 - 50	31 - 50	—	3000	—	—	5000	1500	TC1,2, OL0,U1	TC1,2, OL0,U1	Rocker Version 1 - 3 Poles	
			3	0.10 - 30	—	—	5000 <sup>3</sup>	—	3000	1500	3000	1500	TC1,2, OL1,C1	TC1,2, OL1,C1	Rocker Version 1 - 3 Poles
31 - 50	—	—	2000 <sup>2</sup>	—	—	3000	1500	TC1,2, OL1,C1	TC1,2, OL1,C1	Rocker Version 1 - 3 Poles					
SHUNT	80	DC	—	0.10 - 30	—	—	7500	3000	1500	3000	1500	TC1,2, OL1,U1	TC1,2, OL1,U1	Handle Version 1 Pole Only	
	250	50 / 60	1	0.10 - 30	—	—	7500	3000	1500	3000	1500	TC1,2, OL1,U1	TC1,2, OL1,U1	Rocker Version 1 - 3 Poles	
				0.10 - 30	—	—	3000	3000	1500	5000	1500	TC1,2, OL1,U1	TC1,2, OL1,U1	Rocker Version 1 - 3 Poles	
			3	0.10 - 30	—	—	5000 <sup>3</sup>	—	3000	1500	3000	1500	TC1,2, OL1,C1	TC1,2, OL1,C1	Rocker Version 1 - 3 Poles
			31 - 50	—	—	2000 <sup>2</sup>	—	—	3000	1500	TC1,2, OL1,C1	TC1,2, OL1,C1	Rocker Version 1 - 3 Poles		

Notes:

- 1 General Purpose Ratings for UL/CSA Only.
- 2 Requires branch circuit backup with a UL LISTED Type K5 or RK5 fuse (15A minimum) at no more than 4 times the rating of the protector.
- 3 Same as note 2, except that backup fuse is limited to 80 A maximum.
- 4 Satisfies the requirements of clause 11.2.8.2.5 of CSA STD C22.2 No 100 for the use of supplementary protectors with portable generators.

## Electrical Tables

**Table C:** Lists UL Recognized, CSA Accepted configurations and performance capabilities as Protectors, Supplementary for Marine Electrical and Fuel Systems (Guide PEQZ2, File E75596). Ignition Protected per UL 1500. UL Classified Small Craft Electrical Devices, Marine in accordance with ISO 8846 (Guide UZMK, File MQ1515) as Marine Supplementary Protectors.

A-SERIES TABLE C: UL1500 (Marine Ignition Protected)							
CIRCUIT CONFIGURATION	VOLTAGE			CURRENT RATING	SHORT CIRCUIT CAPACITY (AMPS)	APPLICATION CODES	
	MAX. RATING	FREQUENCY	PHASE	FULL LOAD AMPS	WITHOUT BACKUP FUSE	UL	CSA
SERIES	14 <sup>1</sup>	DC	---	0.02 - 50	5000	TC1,OL1,U1	TC1,OL1,U1
	32 <sup>1</sup>	DC	---	0.02 - 50	5000	TC1,OL1,U2	TC1,OL1,U2
	65	DC	---	0.02 - 50	3000	TC1,OL1,U1	TC1,OL1,U1
	125	50 / 60	1	0.02 - 50	3000	TC1,OL1,U2	TC1,OL1,U2
	125 / 250	50 / 60	1 <sup>2</sup>	0.02 - 50	3000	TC1,OL1,U2	TC1,OL1,U2
	250	50 / 60	1	0.02 - 30	1500	TC1,OL1,U1	TC1,OL1,U1

Notes:

1 Available with special catalog number only (consult factory).

2 2 pole protector required (with one per power line) for 125 / 250 VAC. 1 pole protector required for 125 VAC 1 phase power system

**Table D:** Lists UL Listed configurations and performance capabilities as Circuit Breakers for use in Communications Equipment (Guide DITT, File E189195), under UL489A.

A-SERIES TABLE D: UL489A (COMMUNICATIONS EQUIPMENT)				
CIRCUIT CONFIGURATION	VOLTAGE		CURRENT RATING	INTERRUPTING CAPACITY (AMPS)
	MAX. RATING	FREQUENCY	GENERAL PURPOSE AMPS	WITHOUT BACKUP FUSE
SERIES	80	DC	0.10 - 50	5000
	80	DC	60 - 90 <sup>1</sup>	5000

Notes:

1 Parallel Pole Construction

## Agency Certifications

### UL Recognized

UL Standard 1077



Component Recognition Program as Protectors Supplementary (Guide CCN/QVNU2, File E75596)

### CSA Accepted



Component Supplementary Protector under Class 3215 30, File 047848 0 000 CSA Standard C22.2 No. 235

UL Standard 508



Switches, Industrial Control (Guide CCN/NRNT2, File E148683)

### TUV Certified



EN60934, under License No. R72103448

UL Standard 1500



Protectors, Supplementary for Marine Electrical & Fuel Systems (Guide PEQZ2, File E75596) Ignition Protection

### VDE Certified



EN60934, VDE 0642 under File No. 10537

### UL Listed

UL Standard 489A



Communications Equipment (Guide CCN/DITT, File E189195)

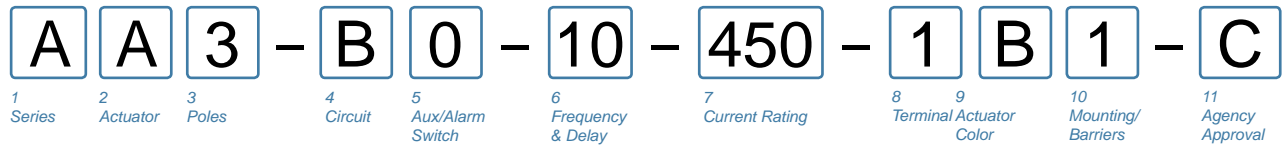

**1 SERIES**

**A**

**2 ACTUATOR <sup>1</sup>**

- A** Handle, one per pole
- B** Handle, one per multipole unit
- S** Mid-Trip Handle, one per pole
- T** Mid-Trip Handle, one per pole & Alarm Switch

**3 POLES**

- |              |                |               |
|--------------|----------------|---------------|
| <b>1</b> One | <b>3</b> Three | <b>5</b> Five |
| <b>2</b> Two | <b>4</b> Four  | <b>6</b> Six  |

**4 CIRCUIT**

- |   |  |
|---|--|
| <b>A</b> <sup>2</sup> Switch Only (No Coil) | <b>F</b> <sup>3</sup> Relay Trip (Current)                     |
| <b>B</b> Series Trip (Current)              | <b>G</b> <sup>3</sup> Relay Trip (Voltage)                     |
| <b>C</b> Series Trip (Voltage)              | <b>H</b> <sup>3,4</sup> Dual Coil with Shunt Trip Voltage Coil |
| <b>D</b> <sup>3</sup> Shunt Trip (Current)  | <b>K</b> <sup>3,4</sup> Dual Coil with Relay Trip Voltage Coil |
| <b>E</b> <sup>3</sup> Shunt Trip (Voltage)  |  |

**5 AUXILIARY / ALARM SWITCH <sup>5</sup>**

- |   |   |
|---|---|
| <b>0</b> without Aux Switch                         | <b>5</b> S.P.S.T., 0.093 Q.C. Term. (Gold Contacts) |
| <b>1</b> S.P.D.T., 0.093 Q.C. Term.                 | <b>7</b> S.P.S.T., 0.110 Q.C. Term. (Gold Contacts) |
| <b>2</b> S.P.D.T., 0.110 Q.C. Term.                 | <b>8</b> S.P.S.T., 0.187 Q.C. Term. (Gold Contacts) |
| <b>4</b> S.P.D.T., 0.110 Q.C. Term. (Gold Contacts) | <b>9</b> S.P.D.T., 0.187 Q.C. Term.                 |

**6 FREQUENCY & DELAY**

- |                                   |  |
|-----------------------------------|--|
| <b>03</b> DC 50/60Hz, Switch Only | <b>30</b> DC, 50/60Hz Instantaneous              |
| <b>10</b> DC Instantaneous        | <b>31</b> DC, 50/60Hz Ultra Short                |
| <b>11</b> DC Ultra Short          | <b>32</b> DC, 50/60Hz Short                      |
| <b>12</b> DC Short                | <b>34</b> DC, 50/60Hz Medium                     |
| <b>14</b> DC Medium               | <b>36</b> DC, 50/60Hz Long                       |
| <b>16</b> DC Long                 | <b>42</b> <sup>7</sup> 50/60Hz Short, Hi-Inrush  |
| <b>20</b> 50/60Hz Instantaneous   | <b>44</b> <sup>7</sup> 50/60Hz Medium, Hi-Inrush |
| <b>21</b> 50/60Hz Ultra Short     | <b>46</b> <sup>7</sup> 50/60Hz Long, Hi-Inrush   |
| <b>22</b> 50/60Hz Short           | <b>52</b> <sup>7</sup> DC, Short, Hi-Inrush      |
| <b>24</b> 50/60Hz Medium          | <b>54</b> <sup>7</sup> DC, Medium, Hi-Inrush     |
| <b>26</b> 50/60Hz Long            | <b>56</b> <sup>7</sup> DC, Long, Hi-Inrush       |

**Notes:**

- 1 Actuator Code:
  - A: Handle tie pin spacer(s) and retainers provided un-assembled with multi-pole units.
  - B: Handle location as viewed from front of breaker:
    - 2 pole - left pole    3 pole - center pole    4 pole - two handles at center poles
    - 5 pole - three handles at center poles    6 pole - four handles at center poles
  - S: Handle moves to mid-position only upon electrical trip of the breaker. Available with circuit codes B, C, D, E, F, G, H and K.
  - T: Handle moves to mid-position and alarm switch activates only upon electrical trip of the breaker. Available with circuit codes B & C.
- 2 Switch Only circuits, rated up to 50 amps and 6 poles, and only available when tied to a protected pole (Circuit Code B, C, D or H.). For .02 to 30 amps, select Current Code 630. For 35 - 50 amps, select Current Code 650.
- 3 Available with terminal Codes 1, 2 and 3. Current Rating limited to 50A amps maximum.
- 4 Consult factory for available Dual Coil options, as special catalog number is required. With Shunt construction, Dual Coils will trip instantaneously on line voltage. Dual coils require 30VA minimum power to trip and are rated for intermittent duty only.
- 5 Auxiliary Switch breakers with Series Trip & Switch Only circuits: ≤ 30A - supplied with standard half shells. 35-50A - supplied with extended boat (B-Style) half shells. On multi-pole breakers, one auxiliary switch is supplied, mounted in the extreme right pole.
- 6 Separate pole type voltage coils not rated for continuous duty. Available only with delay codes 10 and 20.
- 7 Available with Circuit Codes B & D only. VDE Certified to 30 amps. UL Recognized, CSA Accepted & TUV Certified to 50 amps.
- 8 VDE Certification available with single pole breakers with DC Delay only. UL Recognition and CSA Accepted available in one and two pole breakers.
- 9 Screw Terminals are recommended on ratings greater than 20 amps. Ratings over 30 amps are only available with Terminal Codes 5, 9, G, H, M and Q.
- 10 Terminal Code 1: VDE Certification up to 25 amps and UL Recognition and CSA Certification up to 30 amps, but not recommended over 20 amps.
- 11 Terminal Codes 3, 5, E and H (Bus Type) with VDE, are supplied with Lock Washers, and Terminal Code M (M6 Threaded Stud) with VDE is supplied with Lock and Flat Washers. These breakers are only VDE Certified when the washers are used.
- 12 Terminal Code L: VDE Certified available up to 12A. UL Recognized & CSA Accepted available up to 30A.
- 13 Single pole breakers with Terminal Code P (Printed Circuit Board) are available up to 30 amps with VDE Certification and 50 amps with UL Recognition and CSA Accepted, with Circuit Codes A, B and C. Two pole breakers with Terminal Code P (Printed Circuit Board) are available up to 40 amps with UL Recognition and CSA Accepted with Circuit Codes A, B and C.
- 14 Terminal Code Q not available with VDE certification.
- 15 Single pole only.

**7 CURRENT RATING (AMPERES)**

CODE	AMPERES	CODE	AMPERES	CODE	AMPERES	CODE	AMPERES
020	0.020	225	0.250	420	2.000	611	11.000
025	0.025	230	0.300	522	2.250	711	11.500
030	0.030	235	0.350	527	2.750	612	12.000
035	0.035	240	0.400	430	3.000	712	12.500
040	0.040	245	0.450	435	3.500	613	13.000
045	0.045	250	0.500	440	4.000	614	14.000
050	0.050	255	0.550	445	4.500	615	15.000
055	0.055	260	0.600	450	5.000	616	16.000
060	0.060	265	0.650	455	5.500	617	17.000
065	0.065	270	0.700	460	6.000	618	18.000
070	0.070	275	0.750	465	6.500	620	20.000
075	0.075	280	0.800	470	7.000	622	22.000
080	0.080	285	0.850	475	7.500	624	24.000
085	0.085	290	0.900	480	8.000	625	25.000
090	0.090	295	0.950	485	8.500	630	30.000
095	0.095	410	1.000	490	9.000	635	35.000
210	0.100	512	1.250	495	9.500	640	40.000
215	0.150	415	1.500	610	10.000	645	45.000
220	0.200	517	1.750	710	10.500	650	50.000

**OR VOLTAGE COIL (NORMAL RATED VOLTAGE) <sup>6</sup>**

CODE	AMPERES	CODE	AMPERES	CODE	AMPERES	CODE	AMPERES
A06	6 DC	A32	32 DC	J12	12 AC	J65	65 AC
A12	12 DC	A48	48 DC	J18	18 AC	K20	120 AC
A18	18 DC	A65	65 DC	J24	24 AC	L40	240 AC
A24	24 DC	J06	6 AC	J48	48 AC		

**8 TERMINAL <sup>9</sup>**

- |  |  |
|--|--|
| <b>1</b> <sup>10</sup> Push-On 0.250 Tab (Q.C.)    | <b>E</b> <sup>11</sup> Screw M4 (Bus Type)             |
| <b>2</b> Screw 8-32 with upturned lugs             | <b>F</b> Screw M5 with upturned lugs & 30° bend        |
| <b>3</b> <sup>11</sup> Screw 8-32 (Bus Type)       | <b>G</b> Screw M5 (Bus Type) & 30° bend                |
| <b>4</b> Screw 10-32 with upturned lugs            | <b>H</b> <sup>11</sup> Screw M5 (Bus Type)             |
| <b>5</b> <sup>11</sup> Screw 10-32 (Bus Type)      | <b>L</b> <sup>12</sup> 0.250 Q.C./ Solder Lug          |
| <b>6</b> Screw 8-32 with upturned lugs & 30° bend  | <b>M</b> <sup>11</sup> M6 Threaded Stud                |
| <b>7</b> Screw 8-32 (Bus Type) & 30° bend          | <b>Q</b> <sup>14</sup> Push-In Stud                    |
| <b>8</b> Screw 10-32 with upturned lugs & 30° bend | <b>R</b> Screw M4 with upturned lugs & 30° bend        |
| <b>9</b> Screw 10-32 (Bus Type) & 30° bend         | <b>T</b> <sup>11</sup> Screw M4 (Bus Type) & 30° bend  |
| <b>B</b> Screw M5 with upturned lugs               | <b>P</b> <sup>13</sup> Printed Circuit Board Terminals |
| <b>C</b> Screw M4 with upturned lugs               | <b>S</b> <sup>13</sup> Push-On 0.110 Tab (Q.C.)        |

**9 ACTUATOR COLOR & LEGEND**

Actuator Color	I-O	ON-OFF	Dual	Legend Color
White	A	B	1	Black
Black	C	D	2	White
Red	F	G	3	White
Green	H	J	4	White
Blue	K	L	5	White
Yellow	M	N	6	Black
Gray	P	Q	7	Black
Orange	R	S	8	Black
Black (short handle) <sup>15</sup>	T	U	9	White

**10 MOUNTING / BARRIERS**

MOUNTING STYLE	BARRIERS
<b>Threaded Insert, 2 per pole</b>	
<b>1</b> 6-32 x 0.195 inches	no
<b>A</b> 6-32 x 0.195 inches	yes
<b>2</b> ISO M3 x 5mm	no
<b>B</b> ISO M3 x 5mm (multipole only)	yes
<b>Front panel Snap-In, 0.75" wide bezel</b>	
<b>5</b> without Handleguard	no
<b>6</b> without Handleguard (multipole only)	yes
<b>Front panel Snap-In, 0.96" wide bezel</b>	
<b>7</b> without Handleguard, 1-pole 0.96" wide; multipole units have .105" bezel overhang on all sides	no
<b>8</b> without Handleguard, 1-pole 0.96" wide; (multipole only) .105" bezel overhang on all sides	yes

**11 AGENCY APPROVAL**

- D** UL Recognized & CSA Accepted
- C** VDE Certified, UL Recognized & CSA Accepted
- E** TUV Certified, UL Recognized & CSA Accepted
- I** UL Recognized STD 1077, UL Recognized 1500 (ignition protected), & CSA Accepted

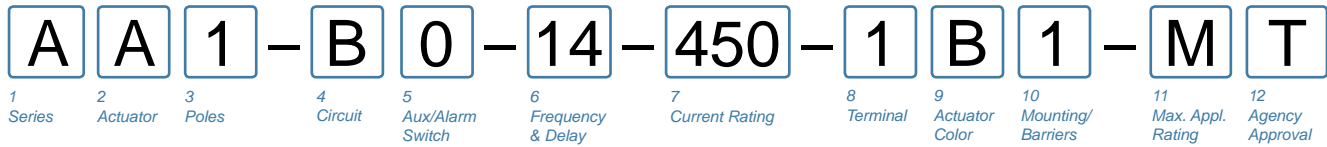

**1 SERIES**  
**A**

**2 ACTUATOR <sup>1</sup>**  
**A** Handle, one per pole  
**S** Mid-Trip Handle, one per pole  
**T** Mid-Trip Handle, one per pole & Alarm Switch

**3 POLES <sup>2</sup>**  
**1** One  
**2** Two  
**3** Three  
**4** Four

**4 CIRCUIT**  
**B** Series Trip (Current)

**5 AUXILIARY/ALARM SWITCH <sup>2</sup>**

<b>0</b> without Aux Switch	<b>7</b> S.P.S.T., 0.110 Q.C. Term. (Gold Contacts)
<b>1</b> S.P.D.T., 0.093 Q.C. Term.	<b>8</b> S.P.S.T., 0.187 Q.C. Term.
<b>2</b> S.P.D.T., 0.110 Q.C. Term.	<b>9</b> S.P.D.T., 0.187 Q.C. Term.

**6 FREQUENCY & DELAY**

<b>11</b> DC Ultra Short	<b>52<sup>3</sup></b> DC, Short, Hi-Inrush
<b>12</b> DC Short	<b>54<sup>3</sup></b> DC, Medium, Hi-Inrush
<b>14</b> DC Medium	<b>56<sup>3</sup></b> DC, Long, Hi-Inrush
<b>16</b> DC Long	

**7 CURRENT RATING (AMPERES)**

CODE	AMPERES				
210	0.100	285	0.850	455	5.500
215	0.150	290	0.900	460	6.000
220	0.200	295	0.950	465	6.500
225	0.250	410	1.000	470	7.000
230	0.300	512	1.250	475	7.500
235	0.350	415	1.500	480	8.000
240	0.400	517	1.750	485	8.500
245	0.450	420	2.000	490	9.000
250	0.500	522	2.250	495	9.500
255	0.550	527	2.750	610	10.000
260	0.600	430	3.000	710	10.500
265	0.650	435	3.500	611	11.000
270	0.700	440	4.000	711	11.500
275	0.750	445	4.500	612	12.000
280	0.800	450	5.000	712	12.500
				613	13.000
				614	14.000
				615	15.000
				616	16.000
				617	17.000
				618	18.000
				620	20.000
				622	22.000
				624	24.000
				625	25.000
				630	30.000
				635 <sup>3</sup>	35.000
				640 <sup>3</sup>	40.000
				645 <sup>3</sup>	45.000
				650 <sup>3</sup>	50.000

**8 TERMINAL <sup>5</sup>**

<b>1<sup>6</sup></b> Push-On 0.250 Tab (Q.C.)	<b>9</b> Screw 10-32 (Bus Type) & 30° bend
<b>2</b> Screw 8-32 with upturned lugs	<b>B</b> Screw M5 with upturned lugs
<b>3<sup>7</sup></b> Screw 8-32 (Bus Type)	<b>F</b> Screw M5 with upturned lugs & 30° bend
<b>4</b> Screw 10-32 with upturned lugs	<b>G</b> Screw M5 (Bus Type) & 30° bend
<b>5<sup>7</sup></b> Screw 10-32 (Bus Type)	<b>H</b> Screw M5 (Bus Type)
<b>6</b> Screw 8-32 with upturned lugs & 30° bend	<b>M<sup>7</sup></b> M6 Threaded Stud
<b>7</b> Screw 8-32 (Bus Type) & 30° bend	<b>P<sup>8</sup></b> Printed Circuit Board Terminals
<b>8</b> Screw 10-32 with upturned lugs & 30° bend	<b>Q<sup>9</sup></b> Push-In Stud

**9 ACTUATOR COLOR & LEGEND**

Actuator Color	ON-OFF	Dual	Legend Color
White	<b>B</b>	<b>1</b>	Black
Black	<b>D</b>	<b>2</b>	White
Red	<b>G</b>	<b>3</b>	White
Green	<b>J</b>	<b>4</b>	White
Blue	<b>L</b>	<b>5</b>	White
Yellow	<b>N</b>	<b>6</b>	Black
Gray	<b>Q</b>	<b>7</b>	Black
Orange	<b>S</b>	<b>8</b>	Black
Black (short handle) <sup>10</sup>	<b>U</b>	<b>9</b>	White

**10 MOUNTING / BARRIERS**

MOUNTING STYLE	BARRIERS
<b>Threaded Insert, 2 per pole</b>	
<b>1</b> 6-32 x 0.195 inches	no
<b>A</b> 6-32 x 0.195 inches	yes
<b>2</b> ISO M3 x 5mm	no
<b>B</b> ISO M3 x 5mm (multipole only)	yes
<b>Front panel Snap-In, 0.75" wide bezel</b>	
<b>5</b> without Handguard	no
<b>6</b> without Handguard (multipole only)	yes
<b>Front panel Snap-In, 0.96" wide bezel</b>	
<b>7</b> without Handguard, 1-pole 0.96" wide; multipole units have .105" bezel overhang on all sides	no
<b>8</b> without Handguard, 1-pole 0.96" wide; (multipole only) .105" bezel overhang on all sides	yes

**11 MAXIMUM APPLICATION RATING**  
**M** 80 DC

**12 AGENCY APPROVAL**  
**T** UL489A Listed  
**K** UL489A Listed, VDE Certified  
**J** UL489A Listed, TUV Certified

- Notes:
- 1 Actuator Code:  
 A: Handle tie pin spacer(s) and retainers provided un-assembled with multi-pole units.  
 S: Handle moves to mid-position only upon electrical trip of the breaker.  
 T: Handle moves to mid-position and alarm switch activates only upon electrical trip of the breaker.
  - 2 On multi-pole breakers, one auxiliary switch is supplied, mounted in the extreme right pole.
  - 3 VDE Certified to 30 amps. UL489A Listed to 50 amps.
  - 4 VDE Certification available with single pole breakers only. UL489A Listing available with one and two pole breakers.
  - 5 Screw Terminals are recommended on ratings greater than 20 amps. Ratings over 30 amps are only available with Terminal Codes 5, 9 G, H, M and Q.
  - 6 Terminal Code 1 (Push-On) available up to 25 amps with VDE Certification and 30 amps with UL489A Listing, but is not recommended over 20 amps.
  - 7 Terminal Codes 3, 5 and H (Bus Type) with VDE, are supplied with Lock Washers, and Terminal Code M (M6 Threaded Stud) with VDE is supplied with Lock and Flat Washers. These breakers are only VDE Certified when the washers are used.
  - 8 Single pole breakers with Terminal Code P (Printed Circuit Board) are available up to 30 amps with VDE Certification and 50 amps with UL489A Listing.
  - 9 Terminal Code Q not available with VDE certification.
  - 10 Single pole only.

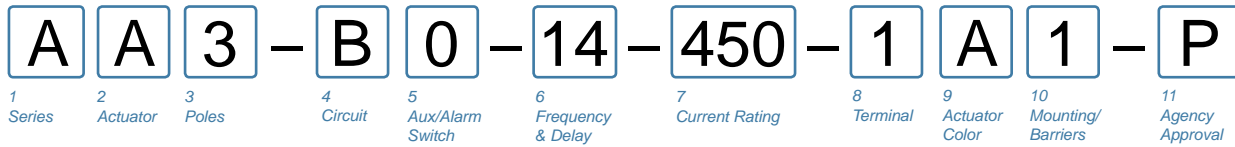

**1 SERIES**  
A

**2 ACTUATOR <sup>1</sup>**  
**A** Handle, one per pole  
**B** Handle, one per multipole unit  
**S** Mid-Trip Handle, one per pole  
**T** Mid-Trip Handle, one per pole & Alarm Switch

**3 POLES**  
**1** One                                **3** Three                                **5** Five  
**2** Two                                **4** Four                                **6** Six

**4 CIRCUIT**  
**A**<sup>2</sup> Switch Only (No Coil)                                **D**<sup>3</sup> Shunt Trip (Current)  
**B** Series Trip (Current)                                **E**<sup>3</sup> Shunt Trip (Voltage)  
**C** Series Trip (Voltage)                                **H**<sup>3,4</sup> Dual Coil with Shunt Trip Voltage Coil

**5 AUXILIARY / ALARM SWITCH <sup>5</sup>**  
**0** without Aux Switch  
**2** S.P.D.T., 0.110 Q.C. Term.  
**4** S.P.D.T., 0.110 Q.C. Term. (Gold Contacts)

**6 FREQUENCY & DELAY**  
**03** DC 50/60Hz, Switch Only                                **30** DC, 50/60Hz Instantaneous  
**10** DC Instantaneous                                **31** DC, 50/60Hz Ultra Short  
**11** DC Ultra Short                                **32** DC, 50/60Hz Short  
**12** DC Short                                **34** DC, 50/60Hz Medium  
**14** DC Medium                                **36** DC, 50/60Hz Long  
**16** DC Long                                **42**<sup>7</sup> 50/60Hz Short, Hi-Inrush  
**20** 50/60Hz Instantaneous                                **44**<sup>7</sup> 50/60Hz Medium, Hi-Inrush  
**21** 50/60Hz Ultra Short                                **46**<sup>7</sup> 50/60Hz Long, Hi-Inrush  
**22** 50/60Hz Short                                **52**<sup>7</sup> DC, Short, Hi-Inrush  
**24** 50/60Hz Medium                                **54**<sup>7</sup> DC, Medium, Hi-Inrush  
**26** 50/60Hz Long                                **56**<sup>7</sup> DC, Long, Hi-Inrush

**7 CURRENT RATING (AMPERES)**  

CODE	AMPERES				
210	0.100	285	0.850	455	5.500
215	0.150	290	0.900	460	6.000
220	0.200	295	0.950	465	6.500
225	0.250	410	1.000	470	7.000
230	0.300	512	1.250	475	7.500
235	0.350	415	1.500	480	8.000
240	0.400	517	1.750	485	8.500
245	0.450	420	2.000	490	9.000
250	0.500	522	2.250	495	9.500
255	0.550	527	2.750	610	10.000
260	0.600	430	3.000	710	10.500
265	0.650	435	3.500	611	11.000
270	0.700	440	4.000	711	11.500
275	0.750	445	4.500	612	12.000
280	0.800	450	5.000	712	12.500
613	13.000				
614	14.000				
615	15.000				
616	16.000				
617	17.000				
618	18.000				
620	20.000				
622	22.000				
624	24.000				
625	25.000				
630	30.000				
635	35.000				
640	40.000				
645	45.000				
650	50.000				

**OR VOLTAGE COIL (NORMAL RATED VOLTAGE) <sup>6</sup>**  

CODE	AMPERES				
A06	6 DC	A32	32 DC	J12	12 AC
A12	12 DC	A48	48 DC	J18	18 AC
A18	18 DC	A65	65 DC	J24	24 AC
A24	24 DC	J06	6 AC	J48	48 AC
J65	65 AC				
K20	120 AC				
L40	240 AC				

**8 TERMINAL <sup>9</sup>**  
**1**<sup>10</sup> Push-On 0.250 Tab (Q.C.)                                **B** Screw M5 with upturned lugs  
**2** Screw 8-32 with upturned lugs                                **C** Screw M4 with upturned lugs  
**3**<sup>11</sup> Screw 8-32 (Bus Type)                                **E**<sup>11</sup> Screw M4 (Bus Type)  
**4** Screw 10-32 with upturned lugs                                **F** Screw M5 with upturned lugs  
**5**<sup>11</sup> Screw 10-32 (Bus Type)                                & 30° bend  
**6** Screw 8-32 with upturned lugs                                **G** Screw M5 (Bus Type) & 30° bend  
 & 30° bend                                **H**<sup>11</sup> Screw M5 (Bus Type)  
**7** Screw 8-32 (Bus Type)                                **R** Screw M4 with upturned lugs  
 & 30° bend                                & 30° bend  
**8** Screw 10-32 with upturned lugs                                **T**<sup>11</sup> Screw M4 (Bus Type)  
 & 30° bend                                & 30° bend  
**9** Screw 10-32 (Bus Type)                                & 30° bend

**9 ACTUATOR COLOR & LEGEND**  

Actuator Color	I-O	Dual	Legend Color
White	A	1	Black
Black	C	2	White
Red	F	3	White
Green	H	4	White
Blue	K	5	White
Yellow	M	6	Black
Gray	P	7	Black
Orange	R	8	Black
Black (short handle) <sup>15</sup>	T	9	White

**10 MOUNTING / BARRIERS**  
**MOUNTING STYLE**  
**Threaded Insert, 2 per pole**  
**1** 6-32 x 0.195 inches                                no  
**A** 6-32 x 0.195 inches                                yes  
**2** ISO M3 x 5mm                                no  
**B** ISO M3 x 5mm (multipole only)                                yes  
**Front panel Snap-In, 0.75" wide bezel**  
**5** without Handleguard                                no  
**6** without Handleguard (multipole only)                                yes  
**Front panel Snap-In, 0.96" wide bezel**  
**7** without Handleguard, 1-pole 0.96" wide;                                no  
 multipole units have .105" bezel overhang on all sides  
**8** without Handleguard, 1-pole 0.96" wide;                                yes  
 (multipole only) .105" bezel overhang on all sides

**11 AGENCY APPROVAL**  
**P** TUV Certified, UL Recognized & CSA Accepted  
**Q** UL Recognized STD 1077, UL Recognized 1500 (ignition protected), & CSA Accepted

Notes:  
 1 Actuator Code:  
 A: Handle tie pin spacer(s) and retainers provided unassembled with multi-pole units.  
 S: Handle moves to mid-position only upon electrical trip of the breaker. Available with circuit codes B, C, D, E, and H.  
 T: Handle moves to mid-position and alarm switch activates only upon electrical trip of the breaker. Available with circuit codes B & C.  
 2 Switch Only circuits, rated up to 50 amps and 6 poles, and only available when tied to a protected pole (Circuit Code B, C, D or H). For .01 to 30 amps, select Current Code 630. For 35 - 50 amps, select Current Code 650.  
 3 Available with terminal Codes 1, 2 and 3. Current Rating limited to 30 amps maximum.  
 4 Consult factory for available Dual Coil options, as special catalog number is required. With Shunt construction, Dual Coils will trip instantaneously on line voltage. Dual coils require 30VA minimum power to trip and are rated for intermittent duty only.  
 5 On multi-pole breakers, one auxiliary switch is supplied, mounted in the extreme right pole.  
 6 Separate pole type voltage coils not rated for continuous duty. Available only with delay codes 10, 20 & 30.  
 7 Available with Circuit Codes B & D only. VDE Certified to 30 amps. UL Recognized, CSA Accepted & TUV Certified to 50 amps.  
 8 Available up to two poles with AC or DC delays.  
 9 Screw Terminals are recommended on ratings greater than 20 amps. Ratings over 30 amps are only available with Terminal Codes 5, 9, G and H.  
 10 Terminal Code 1: TUV Certification up to 30 amps, but not recommended over 20 amps.  
 11 Terminal Codes 3, 5, 7, 9, E, G and H (Bus Type) are supplied with Lock Washers. These breakers are only TUV Certified when the washers are used.  
 12 Single pole only.

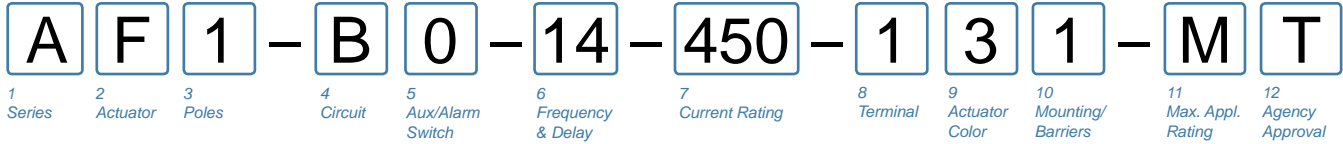

**1 SERIES**  
A

**2 ACTUATOR 1**  
**Two Color Visi-Rocker**  
**C** Indicate ON, vertical legend  
**D** Indicate ON, horizontal legend  
**F** Indicate OFF, vertical legend  
**G** Indicate OFF, horizontal legend  
**Single color**  
**J** Vertical legend  
**K** Horizontal legend  
**Push-To-Reset, Visi-Rocker**  
**N** Indicate OFF, vertical legend  
**O** Indicate OFF, horizontal legend  
**Push-To-Reset, Single color**  
**R** Vertical legend  
**U** Horizontal legend

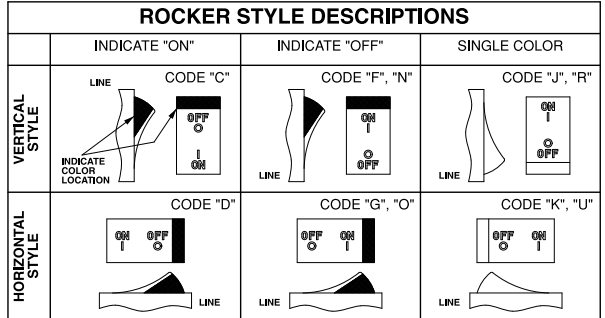

**3 POLES 2**  
**1** One  
**2** Two  
**3** Three

**4 CIRCUIT**  
**B** Series Trip (Current)

**5 AUXILIARY / ALARM SWITCH 2**  
**0** without Aux Switch  
**1** S.P.D.T., 0.093 Q.C. Term.  
**2** S.P.D.T., 0.110 Q.C. Term.  
**7** S.P.S.T., 0.110 Q.C. Term. (Gold Contacts)  
**8** S.P.S.T., 0.187 Q.C. Term.  
**9** S.P.D.T., 0.187 Q.C. Term.

**6 FREQUENCY & DELAY**  
**11** DC Ultra Short  
**12** DC Short  
**14** DC Medium  
**16** DC Long  
**52** DC, Short, Hi-Inrush  
**54** DC, Medium, Hi-Inrush  
**56** DC, Long, Hi-Inrush

**7 CURRENT RATING (AMPERES)**

CODE	AMPERES	285	0.850	455	5.500	613	13.000
210	0.100	285	0.850	455	5.500	613	13.000
215	0.150	290	0.900	460	6.000	614	14.000
220	0.200	295	0.950	465	6.500	615	15.000
225	0.250	410	1.000	470	7.000	616	16.000
230	0.300	512	1.250	475	7.500	617	17.000
235	0.350	415	1.500	480	8.000	618	18.000
240	0.400	517	1.750	485	8.500	620	20.000
245	0.450	420	2.000	490	9.000	622	22.000
250	0.500	522	2.250	495	9.500	624	24.000
255	0.550	527	2.750	610	10.000	625	25.000
260	0.600	430	3.000	710	10.500	630	30.000
265	0.650	435	3.500	611	11.000	635	35.000
270	0.700	440	4.000	711	11.500	640	40.000
275	0.750	445	4.500	612	12.000	645	45.000
280	0.800	450	5.000	712	12.500	650	50.000

**8 TERMINAL 5**  
**1**<sup>6</sup> Push-On 0.250 Tab (Q.C.)  
**2** Screw 8-32 with upturned lugs  
**3**<sup>7</sup> Screw 8-32 (Bus Type)  
**4**<sup>7</sup> Screw 10-32 with upturned lugs  
**5**<sup>7</sup> Screw 10-32 (Bus Type)  
**6** Screw 8-32 with upturned lugs & 30° bend  
**7** Screw 8-32 (Bus Type) & 30° bend  
**8** Screw 10-32 with upturned lugs & 30° bend  
**9** Screw 10-32 (Bus Type) & 30° bend  
**B** Screw M5 with upturned lugs  
**F** Screw M5 with upturned lugs & 30° bend  
**G** Screw M5 (Bus Type) & 30° bend  
**H** Screw M5 (Bus Type)  
**M**<sup>7</sup> M6 Threaded Stud  
**P**<sup>8</sup> Printed Circuit Board Terminals  
**Q**<sup>9</sup> Push-In Stud

**9 ACTUATOR COLOR & LEGEND**

Actuator or Visi-Color <sup>10</sup>	Marking:		Marking Color	
	ON-OFF	Dual <sup>10</sup>	Single Color	Visi-Rocker
White	B	1	Black	White
Black	D	2	White	n/a
Red	G	3	White	Red
Green	J	4	White	Green
Blue	L	5	White	Blue
Yellow	N	6	Black	Yellow
Gray	Q	7	Black	Gray
Orange	S	8	Black	Orange

**10 MOUNTING / BARRIERS 11**

	STANDARD ROCKER BEZEL Threaded Insert, 2 per pole	BARRIERS
<b>1</b>	6-32 x 0.195 inches	no
<b>A</b>	6-32 X 0.195 inches (multi-pole units only)	yes
<b>2</b>	ISO M3 x 5mm	no
<b>B</b>	ISO M3 x 5mm (multi-pole units only)	yes
	<b>ROCKERGUARD &amp; PUSH-TO-RESET BEZEL Threaded Insert, 2 per pole</b>	
<b>3</b>	6-32 x 0.195 inches	no
<b>C</b>	6-32 x 0.195 inches (multi-pole units only)	yes
<b>4</b>	ISO M3 x 5mm	no
<b>D</b>	ISO M3 x 5mm (multi-pole units only)	yes
	<b>FRONT PANEL SNAP-IN BRACKET, 0.744" [18.90mm] wide bezel</b>	
<b>8</b>	without Rockerguard (single pole units only)	no
<b>H</b>	with Rockerguard (single pole units only)	no
	<b>FRONT PANEL SNAP-IN BRACKET, 0.96" [24.48mm] wide bezel</b>	
<b>9</b>	without Rockerguard (single pole units only)	no
<b>J</b>	with Rockerguard (single pole units only)	no

**11 MAXIMUM APPLICATION RATING**  
**M** 80 DC

**12 AGENCY APPROVAL**  
**T** UL489A Listed  
**K** UL489A Listed, VDE Certified  
**J** UL489A Listed, TUV Certified

Notes:  
**1** Push-To-Reset actuators have OFF portion of rocker shrouded.  
**2** Multi-pole breakers have all breakers identical except when specifying Auxiliary switch and/or mixed poles, and have one rocker per breaker.  
**3** Auxiliary Switch breakers with Series Trip circuits: ≤30A, are supplied with standard half shells. 30-50A are supplied with extended boat (B-Style) half shells.  
**4** VDE Certification available with single pole breakers only. UL489A Listing available with one and two pole breakers.  
**5** Screw Terminals are recommended on ratings greater than 20 amps. Ratings over 30 amps are only available with Terminal Codes 5, 9, G, H, M and Q.  
**6** Terminal Code 1 (Push-On) available up to 25 amps with TUV or VDE Certification and 30 amps with UL489A Listing, but is not recommended over 20 amps.  
**7** Terminal Codes 3, 5 and H (Bus Type) with TUV or VDE, are supplied with Lock Washers, and Terminal Code M (M6 Threaded Stud) with VDE is supplied with Lock and Flat Washers. These breakers are only TUV or VDE Certified when the washers are used.  
**8** Single pole breakers with Terminal Code P (Printed Circuit Board) are available up to 30 amps with VDE Certification and 50 amps with UL489A Listing.  
**9** Terminal Code Q not available with VDE certification.  
**10** Color shown is Visi and Legend with remainder of rocker black. Dual = ON-OFF/I-O legend.  
**11** Legend on Push-to-reset bezel/shroud is white with single color actuator codes R & U. Legend on Push-To-Reset bezel/shroud matches Visi-Color of rocker with actuator codes N & O. Rockerguard available with actuator codes C through K

### Circuit & Terminal Diagrams: in. [mm]

CIRCUIT BREAKER PROFILE	CIRCUIT SCHEMATIC		CIRCUIT SCHEMATIC	
	ANSI	CIRCUIT CODE	ANSI	CIRCUIT CODE
<b>2 TERMINALS</b> 	<b>SWITCH ONLY (NO COIL)</b> 	<b>A</b> <b>0</b>	<b>SERIES TRIP</b> 	<b>BC</b> <b>0</b>
<b>5 TERMINALS</b> 	<b>SWITCH ONLY (NO COIL) WITH AUXILIARY SWITCH</b> 	<b>A</b> <b>1</b> <b>2</b> <b>3</b> <b>4</b>	<b>SERIES TRIP WITH (3) AUXILIARY/ALARM SWITCH</b> 	<b>BC</b> <b>1</b> <b>2</b> <b>3</b> <b>4</b>
<b>3 TERMINALS</b> 	<b>SHUNT TRIP</b> 	<b>DE</b> <b>0</b>	<b>DUAL COIL; SERIES TRIP CURRENT COIL, SHUNT TRIP VOLTAGE COIL</b> 	<b>H</b> <b>0</b>
<b>4 TERMINALS</b> 	<b>RELAY TRIP</b> 	<b>FG</b> <b>0</b>	<b>DUAL COIL; SERIES TRIP CURRENT COIL, RELAY TRIP VOLTAGE COIL</b> 	<b>K</b> <b>0</b>

#### AUXILIARY/ALARM SWITCH TERMINAL DETAIL

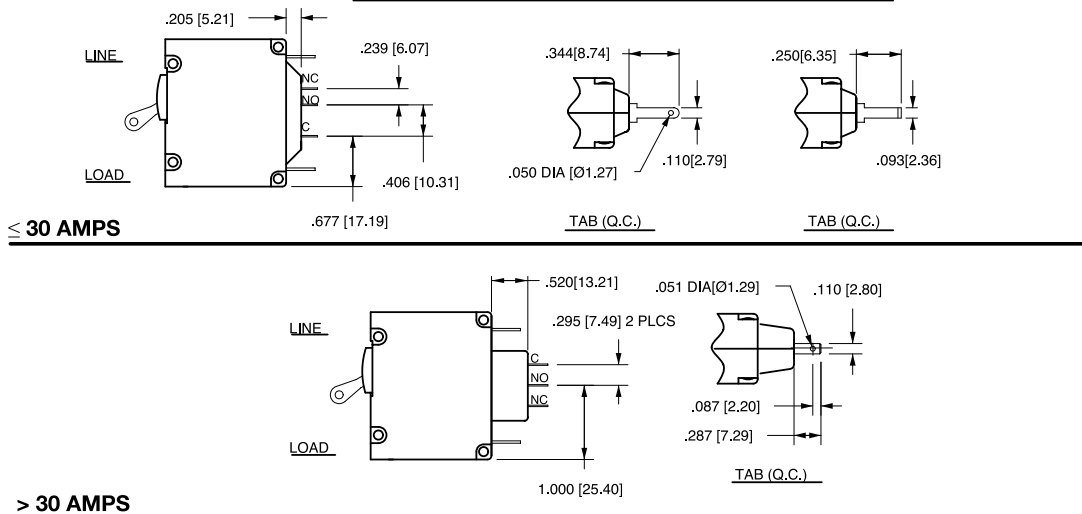

- Notes:
- 1 All dimensions are in inches [millimeters].
  - 2 Tolerance  $\pm .020$  [.51] unless otherwise specified.
  - 3 Alarm Switch available with .110 x .020 Q.C. & Solder Lug Terminals Only.

# Circuit & Terminal Diagrams: in. [mm]

HANDLE POSITION VS. AUX/ALARM SWITCH MODE						
CIRCUIT BREAKER MODE	STANDARD C/B		MID TRIP C/B		MID TRIP C/B	
	HANDLE POSITION	AUX. SWITCH MODE	HANDLE POSITION	ALARM SWITCH MODE	HANDLE POSITION	AUX. SWITCH MODE (w/o ALARM SWITCH)
OFF						
ON						
ELECTRICAL TRIP						

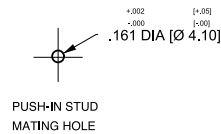
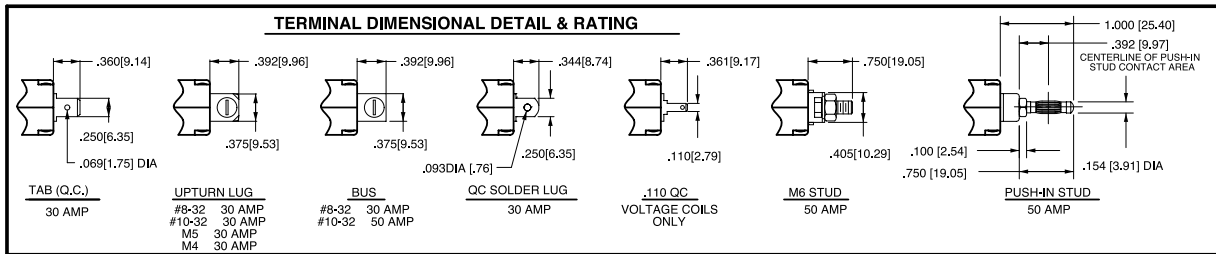

**TABLE A  
TIGHTENING TORQUE SPECIFICATIONS**

THREAD SIZE	TORQUE
#6-32 & M3 MOUNTING HARDWARE	7-9 IN-LBS [0.8-1.0 NM]
#8-32 & M4 THREAD TERMINAL SCREW	12-15 IN-LBS [1.4-1.7 NM]
#10-32 & M5 THREAD TERMINAL SCREW	15-20 IN-LBS [1.7-2.3 NM]

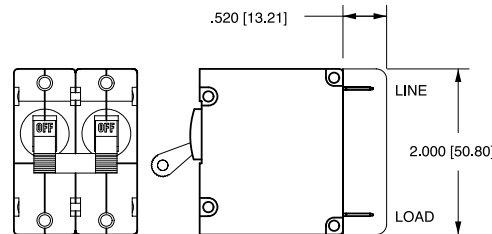

**TABLE B**

TERMINAL DESCRIPTION		DEPTH BEHIND PANEL
MAIN	TAB (Q.C.)	2.000 [50.80]
	SCREW TYPE	2.032 [51.60]
SHUNT, RELAY & DUAL COIL	TAB (Q.C.)	2.207 [56.10]
	SCREW #8-32 W/UPTURNED LUGS	2.364 [60.05]
AUX. SWITCH*	.093 TAB (Q.C.)	2.095 [53.20]
	.110 TAB (Q.C.)	2.189 [55.60]
	SOLDER TYPE	1.970 [50.00]

\* AVAILABLE ON SERIES TRIP AND SWITCH ONLY CIRCUITS. WHEN CALLED FOR ON MULTI-POLE UNITS, ONLY ONE AUX. SWITCH IS NORMALLY SUPPLIED, AS SHOWN IN MULTI-POLE IDENTIFICATION SCHEME.

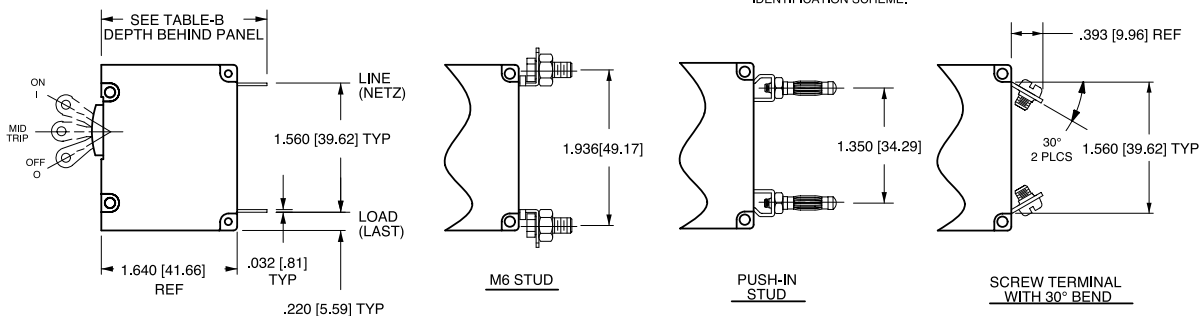

- Notes:
- All dimensions are in inches [millimeters].
  - Tolerance  $\pm 0.02$  [51] unless otherwise specified.
  - Alarm Switch available with .110 x .020 QC & solder lug terminals only.



# Dimensional Specifications: in. [mm]

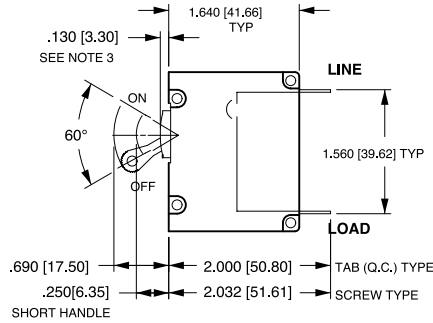
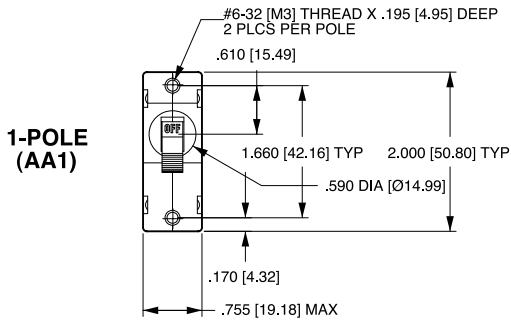

TAB (Q.C.) TYPE TERMINALS IN SERIES TRIP CIRCUIT CONFIGURATION SHOWN. FOR OTHER CONFIGURATIONS, SEE CIRCUIT AND TERMINAL DIAGRAMS.

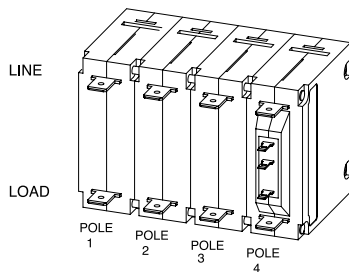
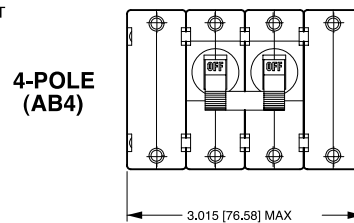
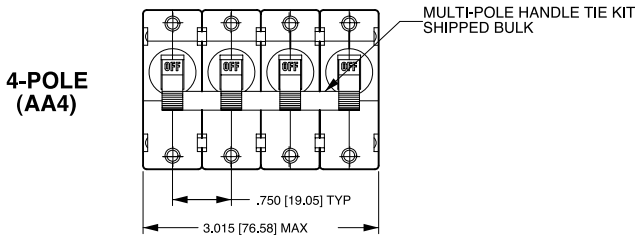
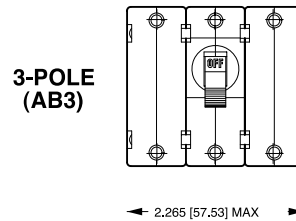
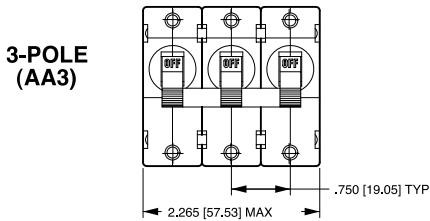
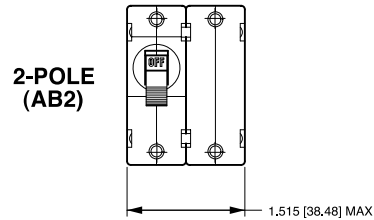
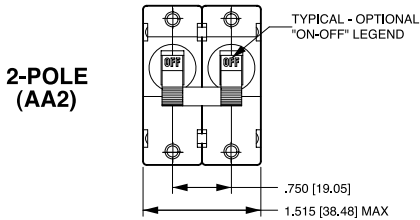

MULTI-POLE IDENTIFICATION SCHEME AS VIEWED FROM TERMINAL END OF BREAKER.

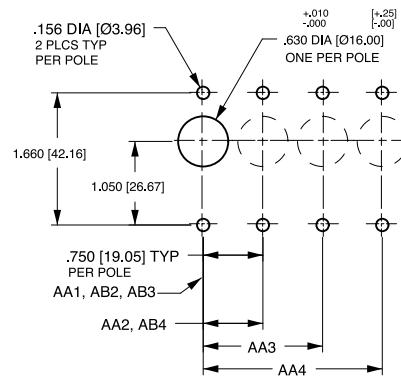

**PANEL CUTOUT DETAIL**  
TOLERANCES ±.005 [±.12] UNLESS OTHERWISE SPECIFIED

Notes:

- 1 All dimensions are in inches [millimeters].
- 2 Tolerance ± 0.20 [.51] unless otherwise specified.
- 3 For agency code P = .150 [3.81].

## Dimensional Specifications: in. [mm]

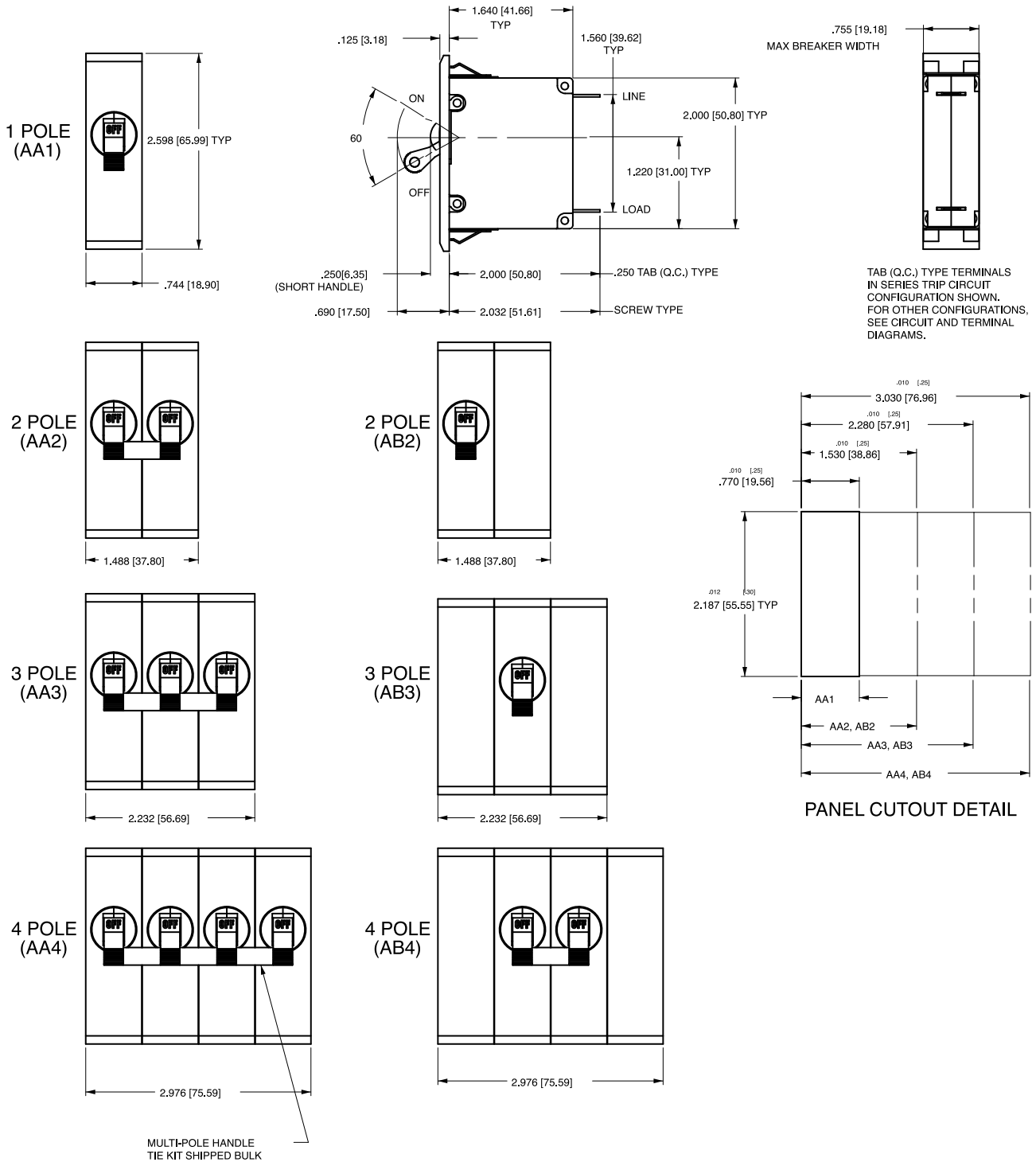

- Notes:  
 1 All dimensions are in inches [millimeters].  
 2 Recommended panel thickness: .040 [1.02] to .100 [2.54].  
 3 Tolerance  $\pm .020$  [.51] unless otherwise specified.

## Dimensional Specifications: in. [mm]

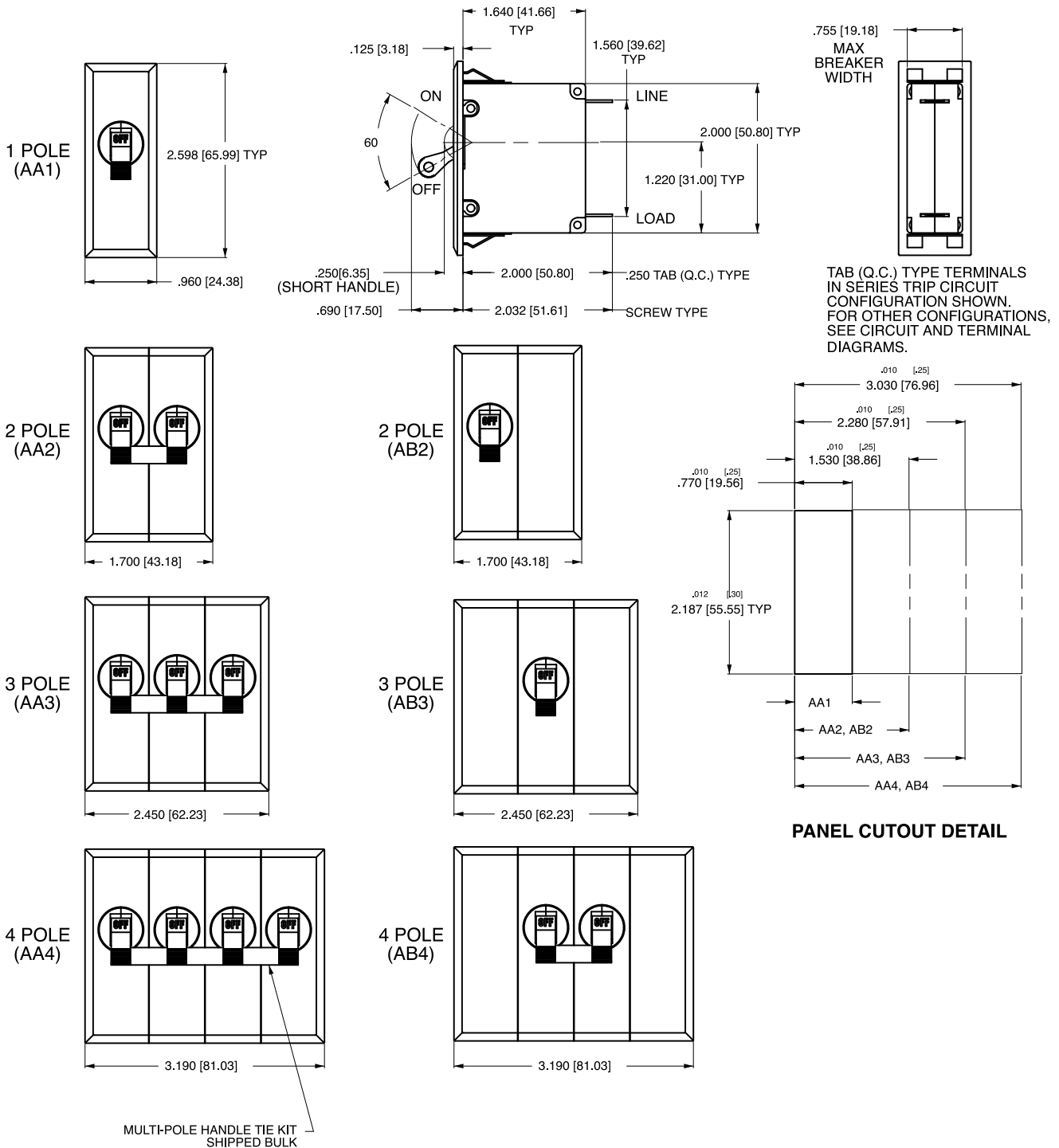

- Notes:
- 1 All dimensions are in inches [millimeters].
  - 2 Recommended panel thickness: .040 [1.02] to .100 [2.54].
  - 3 Tolerance  $\pm 0.020$  [.51] unless otherwise specified.

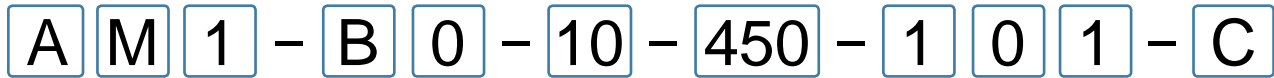

1 Series    2 Actuator    3 Poles    4 Circuit    5 Aux/Alarm Switch    6 Frequency & Delay    7 Current Rating    8 Terminal    9 Actuator Color    10 Mounting/Barriers    11 Agency Approval

**1 SERIES**  
A

**2 ACTUATOR <sup>1</sup>**

M Sealed Toggle, one per unit

**3 POLES**

1 One  
2 Two  
3 Three

**4 CIRCUIT**

A<sup>2</sup> Switch Only (No Coil)    F<sup>3</sup> Relay Trip (Current)  
B Series Trip (Current)    G<sup>3</sup> Relay Trip (Voltage)  
C Series Trip (Voltage)    H<sup>3,4</sup> Dual Coil with Shunt Trip Voltage Coil  
D<sup>3</sup> Shunt Trip (Current)    K<sup>3,4</sup> Dual Coil with Relay Trip Voltage Coil  
E<sup>3</sup> Shunt Trip (Voltage)

**5 AUXILIARY / ALARM SWITCH <sup>5</sup>**

0 without Aux Switch    5 S.P.S.T., 0.093 Q.C. Term. (Gold Contacts)  
1 S.P.D.T., 0.093 Q.C. Term.    7 S.P.S.T., 0.110 Q.C. Term. (Gold Contacts)  
2 S.P.D.T., 0.110 Q.C. Term.    8 S.P.S.T., 0.187 Q.C. Term. (Gold Contacts)  
4 S.P.D.T., 0.110 Q.C. Term. (Gold Contacts)    9 S.P.D.T., 0.187 Q.C. Term. (Gold Contacts)

**6 FREQUENCY & DELAY**

03 DC 50/60Hz, Switch Only    30 DC, 50/60Hz Instantaneous  
10 DC Instantaneous    31 DC, 50/60Hz Ultra Short  
11 DC Ultra Short    32 DC, 50/60Hz Short  
12 DC Short    34 DC, 50/60Hz Medium  
14 DC Medium    36 DC, 50/60Hz Long  
16 DC Long    42<sup>7</sup> 50/60Hz Short, Hi-Inrush  
20 50/60Hz Instantaneous    44<sup>7</sup> 50/60Hz Medium, Hi-Inrush  
21 50/60Hz Ultra Short    46<sup>7</sup> 50/60Hz Long, Hi-Inrush  
22 50/60Hz Short    52<sup>7</sup> DC, Short, Hi-Inrush  
24 50/60Hz Medium    54<sup>7</sup> DC, Medium, Hi-Inrush  
26 50/60Hz Long    56<sup>7</sup> DC, Long, Hi-Inrush

**7 CURRENT RATING (AMPERES)**

CODE	AMPERES				
020	0.020	230	0.300	425	2.500
025	0.025	235	0.350	527	2.750
030	0.030	240	0.400	430	3.000
035	0.035	245	0.450	435	3.500
040	0.040	250	0.500	440	4.000
045	0.045	255	0.550	445	4.500
050	0.050	260	0.600	450	5.000
055	0.055	265	0.650	455	5.500
060	0.060	270	0.700	460	6.000
065	0.065	275	0.750	465	6.500
070	0.070	280	0.800	470	7.000
075	0.075	285	0.850	475	7.500
080	0.080	290	0.900	480	8.000
085	0.085	295	0.950	485	8.500
090	0.090	410	1.000	490	9.000
095	0.095	512	1.250	495	9.500
210	0.100	415	1.500	610	10.000
215	0.150	517	1.750	710	10.500
220	0.200	420	2.000	611	11.000
225	0.250	522	2.250	711	11.500

**OR VOLTAGE COIL (NORMAL RATED VOLTAGE) <sup>6</sup>**

CODE	AMPERES				
A06	6 DC	A32	32 DC	J12	12 AC
A12	12 DC	A48	48 DC	J18	18 AC
A18	18 DC	A65	65 DC	J24	24 AC
A24	24 DC	J06	6 AC	J48	48 AC
				J65	65 AC
				K20	120 AC
				L40	240 AC

**8 TERMINAL <sup>9</sup>**

1<sup>10</sup> Push-On 0.250 Tab (Q.C.)    E Screw M4 (Bus Type)  
2 Screw 8-32 with upturned lugs    F Screw M5 with upturned lugs & 30° bend  
3 Screw 8-32 (Bus Type)    G Screw M5 (Bus Type) & 30° bend  
4 Screw 10-32 with upturned lugs    H Screw M5 (Bus Type)  
5 Screw 10-32 (Bus Type)    L<sup>12</sup> 0.250 Q.C./ Solder Lug  
6 Screw 8-32 with upturned lugs & 30° bend    M M6 Threaded Stud  
7 Screw 8-32 (Bus Type)    Q Push-In Stud  
8 Screw 10-32 with upturned lugs & 30° bend    R Screw M4 with upturned lugs & 30° bend  
9 Screw 10-32 (Bus Type)    T Screw M4 (Bus Type) & 30° bend  
B Screw M5 with upturned lugs    P<sup>12</sup> Printed Circuit Board Terminals  
C Screw M4 with upturned lugs    S Push-On 0.110 Tab (Q.C.)

**9 LEGEND PLATE**

0 No legend plate

**10 MOUNTING / BARRIERS**

	MOUNTING STYLE	BARRIERS
1	Standard Hex Nut	no
A	Standard Hex Nut (multipole only)	yes

**11 AGENCY APPROVAL**

C UL Recognized & CSA Accepted  
I UL Recognized STD 1077, UL Recognized 1500 (ignition protected), & CSA Accepted

Notes:

- Actuator Code M: Handle location as viewed from front of panel:  
2 pole - right pole    3 pole - center pole
- Switch Only circuits, rated up to 50 amps and 3 poles. Only available when tied to a protected pole. For .02 to 30 amps, select Current Code 630. For 35 - 50 amps, select Current Code 650.
- Available with terminal Codes 1, 2 and 3. Current Rating limited to 30 amps maximum.
- Consult factory for available Dual Coil options, as special catalog number is required. With Shunt construction, Dual Coils will trip instantaneously on line voltage. Dual coils require 30VA minimum power to trip and are rated for intermittent duty only.
- Auxiliary Switch available on Series Trip & Switch Only circuits, limited to 30 amps. On multi-pole breakers, one auxiliary switch is supplied, mounted in the extreme right pole.
- Voltage coils not rated for continuous duty. Available only with delay codes 10 and 20.
- Available with Circuit Codes B & D only. VDE Certified to 30 amps. UL Recognized, CSA Accepted & TUV Certified to 50 amps.
- UL Recognition and CSA Certification available on one and two pole breakers.
- Screw Terminals are recommended on ratings greater than 20 amps. Ratings over 30 amps are only available with Terminal Codes 5, 9, B, F, G, H, M and Q.
- Terminal Code 1: UL Recognition and CSA Certification up to 30 amps, but not recommended over 20 amps.
- Terminal Code L: available up to 30A.
- Single pole breakers with Terminal Code P (Printed Circuit Board) are available up to 50 amps, with Circuit Codes A, B and C. Two pole breakers with Terminal Code P (Printed Circuit Board) are available up to 40 amps with Circuit Codes A, B and C.

## Dimensional Specifications: in. [mm]

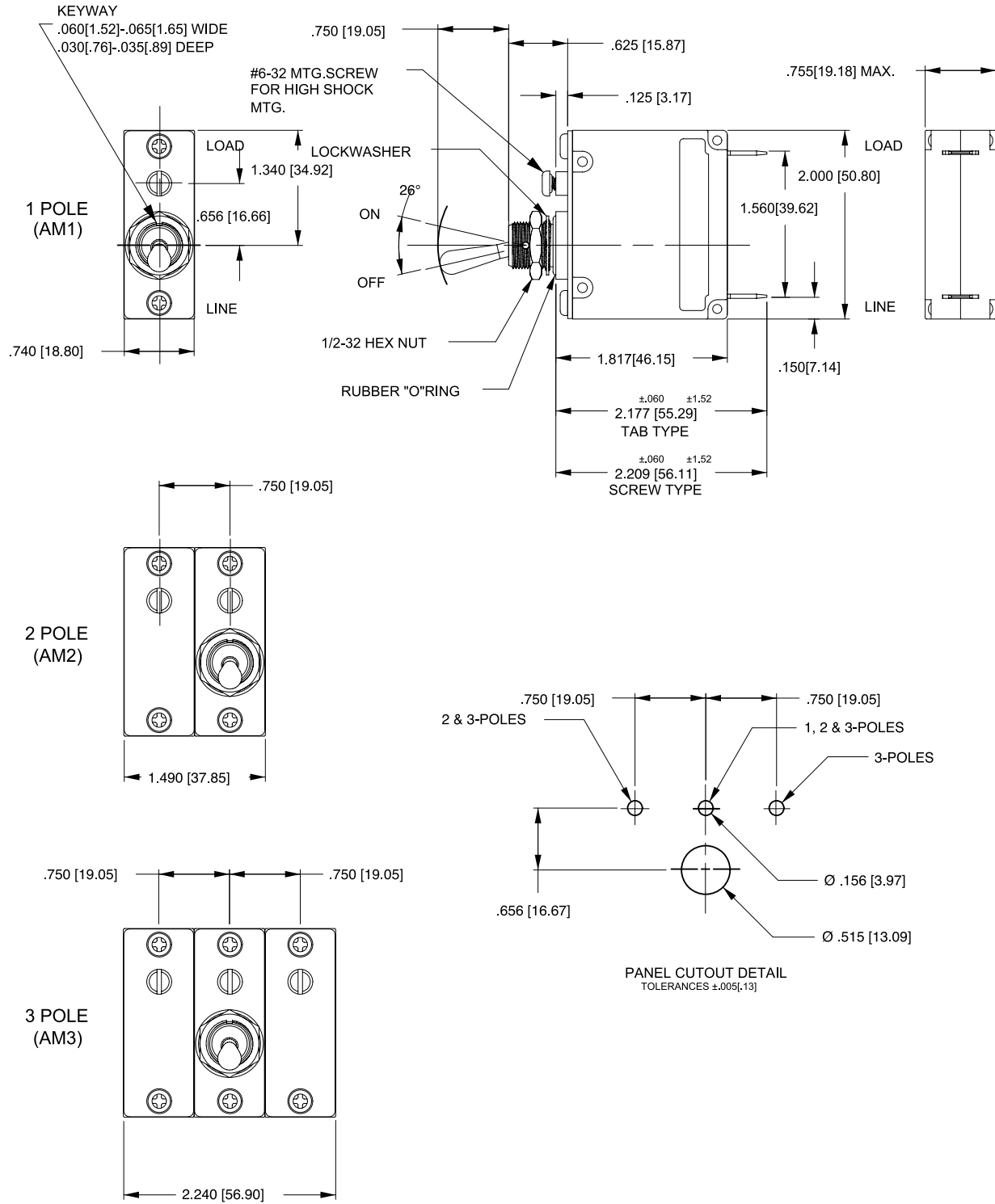

- Notes:
- All dimensions are in inches [millimeters].
  - Tolerance ±.020 [.51] unless otherwise specified.

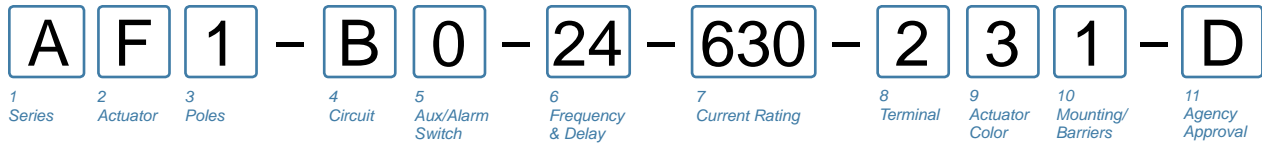

**1 SERIES**

**A**

**2 ACTUATOR 1**

**Two Color Visi-Rocker**

- C** Indicate ON, vertical legend
- D** Indicate ON, horizontal legend
- F** Indicate OFF, vertical legend
- G** Indicate OFF, horizontal legend
- H** Indicate OFF, no legend
- Push-To-Reset, Visi-Rocker**
- N** Indicate OFF, vertical legend
- O** Indicate OFF, horizontal legend
- P** Indicate OFF, no legend

**Single color**

- J** Vertical legend
- K** Horizontal legend
- L** No legend

**Push-To-Reset, Single color**

- R** Vertical legend
- U** Horizontal legend
- V** No legend

**ROCKER STYLE DESCRIPTIONS**

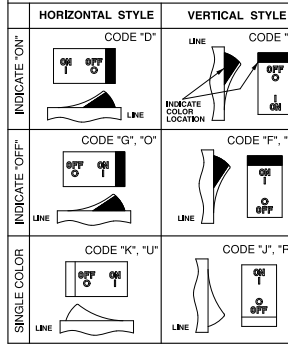

**3 POLES**

- 1** One
- 2** Two
- 3** Three

**4 CIRCUIT**

- A**<sup>3</sup> Switch Only (No Coil)
- B** Series Trip (Current)
- C** Series Trip (Voltage)
- D**<sup>4</sup> Shunt Trip (Current)
- E**<sup>4</sup> Shunt Trip (Voltage)
- F**<sup>4</sup> Relay Trip (Current)
- G**<sup>4</sup> Relay Trip (Voltage)
- H**<sup>4,5</sup> Dual Coil with Shunt Trip Voltage Coil
- K**<sup>4,5</sup> Dual Coil with Relay Trip Voltage Coil

**5 AUXILIARY / ALARM SWITCH 6,7**

- 0** without Aux Switch
- 1** S.P.D.T., 0.093 Q.C. Term.
- 2** S.P.D.T., 0.110 Q.C. Term.
- 4** S.P.D.T., 0.110 Q.C. Term. (Gold Contacts)
- 5** S.P.S.T., 0.093 Q.C. Term. (Gold Contacts)
- 7** S.P.S.T., 0.110 Q.C. Term. (Gold Contacts)
- 8** S.P.S.T., 0.187 Q.C. Term.
- 9** S.P.D.T., 0.187 Q.C. Term.

**6 FREQUENCY & DELAY**

- 03** DC 50/60Hz, Switch Only
- 10** DC Instantaneous
- 11** DC Ultra Short
- 12** DC Short
- 14** DC Medium
- 16** DC Long
- 20** 50/60Hz Instantaneous
- 21** 50/60Hz Ultra Short
- 22** 50/60Hz Short
- 24** 50/60Hz Medium
- 26** 50/60Hz Long
- 30** DC, 50/60Hz Instantaneous
- 31** DC, 50/60Hz Ultra Short
- 32** DC, 50/60Hz Short
- 34** DC, 50/60Hz Medium
- 36** DC, 50/60Hz Long
- 42**<sup>9</sup> 50/60Hz Short, Hi-Inrush
- 44**<sup>9</sup> 50/60Hz Medium, Hi-Inrush
- 46**<sup>9</sup> 50/60Hz Long, Hi-Inrush
- 52**<sup>9</sup> DC, Short, Hi-Inrush
- 54**<sup>9</sup> DC, Medium, Hi-Inrush
- 56**<sup>9</sup> DC, Long, Hi-Inrush

**Notes:**

- 1 Push-To-Reset actuators have OFF portion of rocker shrouded.
- 2 Multi-pole breakers have all breakers identical except when specifying Auxiliary switch and/or mixed poles, and have one rocker per breaker.
- 3 Switch Only circuits, rated up to 50 amps & 3 poles, are available only when tied to a protected pole (Circuit Code B, C, D or H.), For .02 to 30 amps, select Current Code 630. For 35 - 50 amps, select Current Code 650.
- 4 Available with terminal Codes 1, 2 and 3. Current Rating limited to 30 amps maximum.
- 5 Consult factory for Dual Coil options, as special catalog number is required. With Shunt construction, Dual Coils will trip instantaneously on line voltage. Dual coils require 30VA minimum power to trip and are rated for intermittent duty only.
- 6 Auxiliary Switch breakers with Series Trip & Switch Only circuits: ≤30A, are supplied with standard half shells. 30-50A are supplied with extended boat (B-Style) half shells.
- 7 On multi-pole breakers, one auxiliary switch is supplied, mounted in the extreme right pole.
- 8 Separate pole type voltage coils not rated for continuous duty. Available only with delay codes 10 & 20.
- 9 Available with Circuit Codes B & D only. VDE Certified to 30 amps. UL Recognized, CSA Accepted & TUV Certified to 50 amps.
- 10 Series Trip current ratings: VDE Certification available with single pole breakers with DC Delay only. UL Recognition & CSA Accepted available in one and two pole breakers.
- 11 Screw Terminals are recommended on ratings greater than 20 amps. Ratings over 30 amps are only available with Terminal Codes 5, 9, G, H, M and Q.
- 12 Terminal Code 1: VDE Certification up to 25 amps and UL Recognition and CSA Accepted up to 30 amps, but not recommended over 20 amps.
- 13 Terminal Codes 3, 5 E & H (Bus Type) with VDE, are supplied with Lock Washers; Terminal Code M (M6 Threaded Stud) with VDE is supplied with Lock and Flat Washers. These breakers are only VDE Certified when the washers are used.
- 14 VDE Cert. available up to 12 amps. UL Rec. & CSA Accepted available up to 30 amps.
- 15 Single pole breakers with Terminal Code P (Printed Circuit Board) are available up to 30 amps with VDE Certification and 50 amps with UL Recognition and CSA Accepted, with Circuit Codes A, B & C. Two pole breakers with Terminal Code P (Printed Circuit Board) are available up to 40 amps with UL Recognition and CSA Certification with Circuit Codes A, B and C.
- 16 Terminal Code Q not available with VDE.
- 17 Terminal Code S used on voltage coil circuit constructions only.
- 18 Color shown is visi and legend with remainder of rocker black.
- 19 Dual = ON-OFF/I-O legend with actuator. None = no legend on actuator
- 20 Legend on Push-to-reset bezel/shroud is white with single color actuator codes R, & U. Legend on Push-to-reset bezel/shroud matches Visi-color of rocker with actuator codes N & O. Rockerguard available with actuator codes C through L.

**7 CURRENT RATING (AMPERES)**

CODE	AMPERES	225	0.250	420	2.000	611	11.000
020	0.020	230	0.300	522	2.250	711	11.500
025	0.025	235	0.350	527	2.750	612	12.000
030	0.030	240	0.400	430	3.000	712	12.500
035	0.035	245	0.450	435	3.500	613	13.000
040	0.040	250	0.500	440	4.000	614	14.000
045	0.045	255	0.550	445	4.500	615	15.000
050	0.050	260	0.600	450	5.000	616	16.000
055	0.055	265	0.650	455	5.500	617	17.000
060	0.060	270	0.700	460	6.000	618	18.000
065	0.065	275	0.750	465	6.500	620	20.000
070	0.070	280	0.800	470	7.000	622	22.000
075	0.075	285	0.850	475	7.500	624	24.000
080	0.080	290	0.900	480	8.000	625	25.000
085	0.085	295	0.950	485	8.500	630	30.000
090	0.090	410	1.000	490	9.000	635	35.000
095	0.095	512	1.250	495	9.500	640	40.000
210	0.100	415	1.500	610	10.000	645	45.000
215	0.150	517	1.750	710	10.500	650	50.000
220	0.200						

**OR VOLTAGE COIL (NORMAL RATED VOLTAGE) 8**

CODE	AMPERES	A32	32 DC	J12	12 AC	J65	65 AC
A06	6 DC	A48	48 DC	J18	18 AC	K20	120 AC
A12	12 DC	A65	65 DC	J24	24 AC	L40	240 AC
A18	18 DC	J06	6 AC	J48	48 AC		
A24	24 DC						

**8 TERMINAL 11**

- 1**<sup>12</sup> Push-On 0.250 Tab (Q.C.)
- 2** Screw 8-32 with upturned lugs
- 3**<sup>13</sup> Screw 8-32 (Bus Type)
- 4** Screw 10-32 with upturned lugs
- 5**<sup>13</sup> Screw 10-32 (Bus Type)
- 6** Screw 8-32 with upturned lugs & 30° bend
- 7** Screw 8-32 (Bus Type) & 30° bend
- 8** Screw 10-32 with upturned lugs & 30° bend
- 9** Screw 10-32 (Bus Type) & 30° bend
- B** Screw M5 with upturned lugs
- C** Screw M4 with upturned lugs
- E**<sup>13</sup> Screw M4 (Bus Type)
- F** Screw M5 with upturned lugs & 30° bend
- G** Screw M5 (Bus Type) & 30° bend
- H**<sup>13</sup> Screw M5 (Bus Type)
- L**<sup>14</sup> 0.250 Q.C./ Solder Lug
- M**<sup>13</sup> M6 Threaded Stud
- P**<sup>15</sup> Printed Circuit Board Terminals
- Q**<sup>16</sup> Push-In Stud
- R** Screw M4 with upturned lugs & 30° bend
- S**<sup>17</sup> Push-On 0.110 Tab (Q.C.) & 30° bend
- T** Screw M4 (Bus Type) & 30° bend

**9 ACTUATOR COLOR & LEGEND**

Actuator or Visi-Color <sup>12</sup>	Marking:		Marking Color	
	ON-OFF	Dual <sup>12</sup>	Single Color	Visi-Rocker
White	B	1	Black	White
Black	D	2	White	n/a
Red	G	3	White	Red
Green	J	4	White	Green
Blue	L	5	White	Blue
Yellow	N	6	Black	Yellow
Gray	Q	7	Black	Gray
Orange	S	8	Black	Orange

**10 MOUNTING / BARRIERS 20**

	STANDARD ROCKER BEZEL	BARRIERS
	<b>Threaded Insert, 2 per pole</b>	
<b>1</b>	6-32 x 0.195 inches	no
<b>A</b>	6-32 X 0.195 inches (multi-pole units only)	yes
<b>2</b>	ISO M3 x 5mm	no
<b>B</b>	ISO M3 x 5mm (multi-pole units only)	yes
	<b>ROCKERGUARD &amp; PUSH-TO-RESET BEZEL</b>	
	<b>Threaded Insert, 2 per pole</b>	
<b>3</b>	6-32 x 0.195 inches	no
<b>C</b>	6-32 x 0.195 inches (multi-pole units only)	yes
<b>4</b>	ISO M3 x 5mm	no
<b>D</b>	ISO M3 x 5mm (multi-pole units only)	yes
	<b>FRONT PANEL SNAP-IN BRACKET, 0.744" [18.90mm] wide bezel</b>	
<b>8</b>	without Rockerguard (single pole units only)	no
<b>H</b>	with Rockerguard (single pole units only)	no
	<b>FRONT PANEL SNAP-IN BRACKET, 0.96" [24.48mm] wide bezel</b>	
<b>9</b>	without Rockerguard (single pole units only)	no
<b>J</b>	with Rockerguard (single pole units only)	no

**11 AGENCY APPROVAL**

- C** UL Recognized & CSA Accepted
- D** VDE Certified, UL Recognized & CSA Accepted
- E** TUV Certified, UL Recognized & CSA Accepted
- I** UL Recognized STD 1077, UL Recognized 1500 (ignition protected), & CSA Accepted

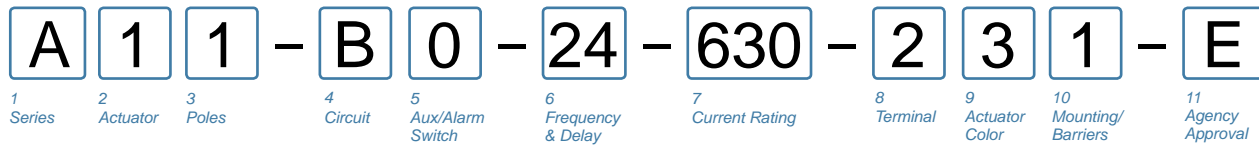

**1 SERIES**  
A

**2 ACTUATOR 1**

- Two Color Visi-Rocker**  
 1 Indicate OFF, vertical legend  
 2 Indicate OFF, horizontal legend  
**Single color**  
 3 Vertical legend  
 4 Horizontal legend  
**Push-To-Reset, Visi-Rocker**  
 5 Indicate OFF, vertical legend  
 6 Indicate OFF, horizontal legend  
**Push-To-Reset, Single color**  
 7 Vertical legend  
 8 Horizontal legend

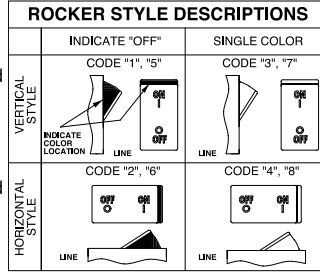

**3 POLES 2**

- 1 One                      2 Two                      3 Three

**4 CIRCUIT**

- A<sup>3</sup> Switch Only (No Coil)  
 B Series Trip (Current)  
 C Series Trip (Voltage)  
 D<sup>4</sup> Shunt Trip (Current)  
 E<sup>4</sup> Shunt Trip (Voltage)  
 F<sup>4</sup> Relay Trip (Current)  
 G<sup>4</sup> Relay Trip (Voltage)  
 H<sup>4,5</sup> Dual Coil with Shunt Trip Voltage Coil  
 K<sup>4,5</sup> Dual Coil with Relay Trip Voltage Coil

**5 AUXILIARY / ALARM SWITCH 6,7**

- 0 without Aux Switch  
 1 S.P.D.T., 0.093 Q.C. Term.  
 2 S.P.D.T., 0.110 Q.C. Term.  
 4 S.P.D.T., 0.110 Q.C. Term.  
 8 S.P.D.T., 0.187 Q.C. Term.  
 9 S.P.D.T., 0.187 Q.C. Term.  
 5 S.P.S.T., 0.093 Q.C. Term. (Gold Contacts)  
 7 S.P.S.T., 0.110 Q.C. Term. (Gold Contacts)  
 8 S.P.S.T., 0.187 Q.C. Term.  
 9 S.P.D.T., 0.187 Q.C. Term.

**6 FREQUENCY & DELAY**

- 03 DC 50/60Hz, Switch Only  
 10<sup>6</sup> DC Instantaneous  
 11 DC Ultra Short  
 12 DC Short  
 14 DC Medium  
 16 DC Long  
 20<sup>6</sup> 50/60Hz Instantaneous  
 21 50/60Hz Ultra Short  
 22 50/60Hz Short  
 24 50/60Hz Medium  
 26 50/60Hz Long  
 30 DC, 50/60Hz Instantaneous  
 31 DC, 50/60Hz Ultra Short  
 32 DC, 50/60Hz Short  
 34 DC, 50/60Hz Medium  
 36 DC, 50/60Hz Long  
 42<sup>9</sup> 50/60Hz Short, Hi-Inrush  
 44<sup>9</sup> 50/60Hz Medium, Hi-Inrush  
 46<sup>9</sup> 50/60Hz Long, Hi-Inrush  
 52<sup>9</sup> DC, Short, Hi-Inrush  
 54<sup>9</sup> DC, Medium, Hi-Inrush  
 56 DC, Long, Hi-Inrush

**7 CURRENT RATING (AMPERES)**

CODE	AMPERES						
020	0.020	225	0.250	420	2.000	611	11.000
025	0.025	230	0.300	522	2.250	711	11.500
030	0.030	235	0.350	527	2.750	612	12.000
035	0.035	240	0.400	430	3.000	712	12.500
040	0.040	245	0.450	435	3.500	613	13.000
045	0.045	250	0.500	440	4.000	614	14.000
050	0.050	255	0.550	445	4.500	615	15.000
055	0.055	260	0.600	450	5.000	616	16.000
060	0.060	265	0.650	455	5.500	617	17.000
065	0.065	270	0.700	460	6.000	618	18.000
070	0.070	275	0.750	465	6.500	620	20.000
075	0.075	280	0.800	470	7.000	622	22.000
080	0.080	285	0.850	475	7.500	624	24.000
085	0.085	290	0.900	480	8.000	625	25.000
090	0.090	295	0.950	485	8.500	630	30.000
095	0.095	410	1.000	490	9.000	635	35.000
210	0.100	512	1.250	495	9.500	640	40.000
215	0.150	415	1.500	610	10.000	645	45.000
220	0.200	517	1.750	710	10.500	650	50.000

**OR VOLTAGE COIL (NORMAL RATED VOLTAGE) 8**

CODE	AMPERES				
A06	6 DC	A32	32 DC	J12	12 AC
A12	12 DC	A48	48 DC	J18	18 AC
A18	18 DC	A65	65 DC	J24	24 AC
A24	24 DC	J06	6 AC	J48	48 AC
				J65	65 AC
				K20	120 AC
				L40	240 AC

**8 TERMINAL 11**

- 1<sup>12</sup> Push-On 0.250 Tab (Q.C.)  
 2 Screw 8-32 with upturned lugs  
 3<sup>13</sup> Screw 8-32 (Bus Type)  
 4 Screw 10-32 with upturned lugs  
 5<sup>13</sup> Screw 10-32 (Bus Type)  
 6 Screw 8-32 with upturned lugs & 30° bend  
 7 Screw 8-32 (Bus Type) & 30° bend  
 8 Screw 10-32 with upturned lugs & 30° bend  
 9 Screw 10-32 (Bus Type) & 30° bend  
 B Screw M5 with upturned lugs  
 C Screw M4 with upturned lugs  
 E<sup>13</sup> Screw M4 (Bus Type)  
 F Screw M5 with upturned lugs & 30° bend  
 G Screw M5 (Bus Type) & 30° bend  
 H<sup>13</sup> Screw M5 (Bus Type)  
 L<sup>14</sup> 0.250 Q.C./ Solder Lug  
 M<sup>13</sup> M6 Threaded Stud  
 P<sup>15</sup> Printed Circuit Board Terminals  
 Q Push-In Stud  
 R Screw M4 with upturned lugs & 30° bend  
 S<sup>16</sup> Push-On 0.110 Tab (Q.C.) & 30° bend  
 T Screw M4 (Bus Type) & 30° bend

**9 ACTUATOR COLOR & LEGEND**

Actuator or Visi-Color <sup>17</sup>	Marking:		Marking Color	
	ON-OFF	Dual <sup>17</sup>	Single Color	Visi-Rocker
White	B	1	Black	White
Black	D	2	White	n/a
Red	G	3	White	Red
Green	J	4	White	Green
Blue	L	5	White	Blue
Yellow	N	6	Black	Yellow
Gray	Q	7	Black	Gray
Orange	S	8	Black	Orange

**10 MOUNTING / BARRIERS 18**

	STANDARD ROCKER BEZEL Threaded Insert, 2 per pole	FLAT ROCKER ACTUATOR	BARRIERS
1	6-32 x 0.195 inches		no
A	6-32 X 0.195 inches (multi-pole units only)		yes
2	ISO M3 x 5mm		no
B	ISO M3 x 5mm (multi-pole units only)		yes
	<b>RECESSED OFF SIDE ROCKER ACTUATOR 19</b>		
5	6-32 x 0.195 inches		no
E	6-32 x 0.195 inches (multi-pole units only)		yes
6	ISO M3 x 5mm		no
F	ISO M3 x 5mm (multi-pole units only)		yes
	<b>PUSH-TO-RESET BEZEL, Threaded Insert, 2 per pole</b>		
3	6-32 x 0.195 inches		no
C	6-32 x 0.195 inches (multi-pole units only)		yes
4	ISO M3 x 5mm		no
D	ISO M3 x 5mm (multi-pole units only)		yes

**11 AGENCY APPROVAL**

- C UL Recognized & CSA Accepted  
 E TUV Certified, UL Recognized & CSA Accepted  
 I UL Recognized STD 1077, UL Recognized 1500 (ignition protected), & CSA Accepted

Notes:

- Push-To-Reset actuators have OFF portion of rocker shrouded.
- Multi-pole breakers have all breakers identical except when specifying Auxiliary switch and/or mixed poles, and have one rocker per breaker.
- Switch Only circuits, rated up to 50 amps & 3 poles. Only available when tied to a protected pole. For .02 to 30 amps, select Current Code 630. For 35 - 50 amps, select Current Code 650.
- Available with terminal Codes 1, 2 and 3. Current Rating limited to 30 amps maximum.
- Consult factory for Dual Coil options, as special catalog number is required. With Shunt construction, Dual Coils will trip instantaneously on line voltage. Dual coils require 30VA minimum power to trip and are rated for intermittent duty only.
- Auxiliary Switch breakers with Series Trip & Switch Only circuits: ≤ 30A, are supplied with standard half shells. 30-50A are supplied with extended boat (B-Style) half shells.
- On multi-pole breakers, one auxiliary switch is supplied, mounted in the extreme right pole.
- Separate pole type voltage coils not rated for continuous duty. Available only with delay codes 10 & 20.
- Available with Circuit Codes B & D only. UL Recognized, CSA Accepted & TUV Certified to 50 amps.
- UL Recognition, CSA Acceptance & TUV Certification available in one and two pole breakers.
- Screw Terminals are recommended on ratings greater than 20 amps. Ratings over 30 amps are only available with Terminal Codes 5, 9, G, H, M and Q.
- Terminal Code 1: Available up to 30 amps, but not recommended over 20 amps.
- Terminal Codes 3, 5 E & H (Bus Type) with TUV, are supplied with Lock Washers; Terminal Code M (M6 Threaded Stud) with TUV is supplied with Lock and Flat Washers. These breakers are only TUV Certified when the washers are used.
- TUV Cert. available up to 12 amps. UL Rec. & CSA Accepted available up to 30 amps.
- Single pole breakers with Terminal Code P (Printed Circuit Board) are available up to 50 amps with UL Recognition, CSA Accepted & TUV Certification, with Circuit Codes A, B and C. Two pole breakers with Terminal Code P (Printed Circuit Board) are available up to 40 amps with UL Recognition and CSA Accepted with Circuit Codes A, B and C.
- Terminal Code S used on voltage coil circuit constructions only.
- Color shown is visi and legend with remainder of rocker black, Dual = ON-OFF/I-O legend.
- Legend on Push-to-reset bezel/shroud is white with single color actuator codes 7 & 8. Legend on Push-To-Reset bezel/shroud matches Visi-Color of rocker with actuator codes 5 & 6.
- Recessed "off-side" available with actuator codes 1, 2, 3 & 4. Legends on rocker are available in ink stamping only.

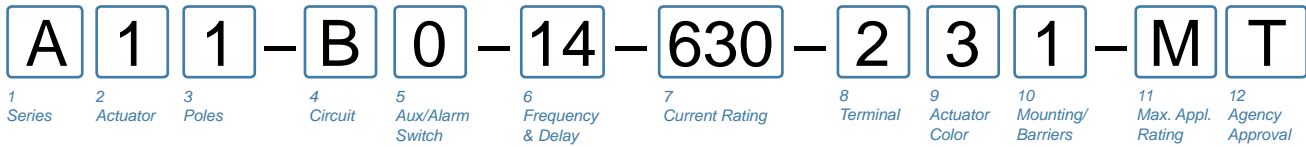

**1 SERIES**  
**A**

**2 ACTUATOR 1**

- Two Color Visi-Rocker**
- 1 Indicate OFF, vertical legend
- 2 Indicate OFF, horizontal legend
- Single color**
- 3 Vertical legend
- 4 Horizontal legend
- Push-To-Reset, Visi-Rocker**
- 5 Indicate OFF, vertical legend
- 6 Indicate OFF, horizontal legend
- Push-To-Reset, Single color**
- 7 Vertical legend
- 8 Horizontal legend

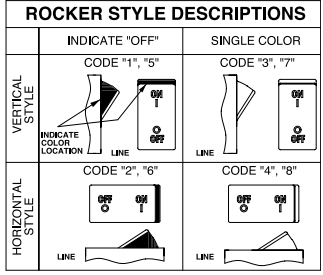

**3 POLES 2**

- 1 One
- 2 Two
- 3 Three

**4 CIRCUIT**

- B** Series Trip (Current)

**5 AUXILIARY / ALARM SWITCH 3**

- 0** without Aux Switch
- 1 S.P.D.T., 0.093 Q.C. Term.
- 2 S.P.D.T., 0.110 Q.C. Term.
- 7 S.P.S.T., 0.110 Q.C. Term. (Gold Contacts)
- 8 S.P.S.T., 0.187 Q.C. Term.
- 9 S.P.D.T., 0.187 Q.C. Term.

**6 FREQUENCY & DELAY**

- 11 DC Ultra Short
- 12 DC Short
- 14 DC Medium
- 16 DC Long
- 52 DC, Short, Hi-Inrush
- 54 DC, Medium, Hi-Inrush
- 56 DC, Long, Hi-Inrush

**7 CURRENT RATING (AMPERES)**

CODE	AMPERES	CODE	AMPERES	CODE	AMPERES	CODE	AMPERES
020	0.020	225	0.250	420	2.000	611	11.000
025	0.025	230	0.300	522	2.250	711	11.500
030	0.030	235	0.350	527	2.750	612	12.000
035	0.035	240	0.400	430	3.000	712	12.500
040	0.040	245	0.450	435	3.500	613	13.000
045	0.045	250	0.500	440	4.000	614	14.000
050	0.050	255	0.550	445	4.500	615	15.000
055	0.055	260	0.600	450	5.000	616	16.000
060	0.060	265	0.650	455	5.500	617	17.000
065	0.065	270	0.700	460	6.000	618	18.000
070	0.070	275	0.750	465	6.500	620	20.000
075	0.075	280	0.800	470	7.000	622	22.000
080	0.080	285	0.850	475	7.500	624	24.000
085	0.085	290	0.900	480	8.000	625	25.000
090	0.090	295	0.950	485	8.500	630	30.000
095	0.095	410	1.000	490	9.000	635	35.000
210	0.100	512	1.250	495	9.500	640	40.000
215	0.150	415	1.500	610	10.000	645	45.000
220	0.200	517	1.750	710	10.500	650	50.000

**8 TERMINAL 5**

- 1<sup>6</sup> Push-On 0.250 Tab (Q.C.)
- 2 Screw 8-32 with upturned lugs
- 3<sup>7</sup> Screw 8-32 (Bus Type)
- 4 Screw 10-32 with upturned lugs
- 5<sup>7</sup> Screw 10-32 (Bus Type)
- 6 Screw 8-32 with upturned lugs & 30° bend
- 7 Screw 8-32 (Bus Type) & 30° bend
- 8 Screw 10-32 with upturned lugs & 30° bend
- 9 Screw 10-32 (Bus Type) & 30° bend
- B** Screw M5 with upturned lugs
- F** Screw M5 with upturned lugs & 30° bend
- G** Screw M5 (Bus Type) & 30° bend
- H** Screw M5 (Bus Type)
- M**<sup>7</sup> M6 Threaded Stud
- P**<sup>8</sup> Printed Circuit Board Terminals
- Q**<sup>9</sup> Push-In Stud

**9 ACTUATOR COLOR & LEGEND**

Actuator or Visi-Color <sup>11</sup>	Marking:		Marking Color	
	ON-OFF	Dual <sup>11</sup>	Single Color	Visi-Rocker
White	<b>B</b>	<b>1</b>	Black	White
Black	<b>D</b>	<b>2</b>	White	n/a
Red	<b>G</b>	<b>3</b>	White	Red
Green	<b>J</b>	<b>4</b>	White	Green
Blue	<b>L</b>	<b>5</b>	White	Blue
Yellow	<b>N</b>	<b>6</b>	Black	Yellow
Gray	<b>Q</b>	<b>7</b>	Black	Gray
Orange	<b>S</b>	<b>8</b>	Black	Orange

**10 MOUNTING / BARRIERS 12**

	STANDARD ROCKER BEZEL	BARRIERS
<b>Threaded Insert, 2 per pole</b>		
<b>FLAT ROCKER ACTUATOR</b>		
<b>1</b>	6-32 x 0.195 inches	no
<b>A</b>	6-32 X 0.195 inches (multi-pole units only)	yes
<b>2</b>	ISO M3 x 5mm	no
<b>B</b>	ISO M3 x 5mm (multi-pole units only)	yes
<b>RECESSED OFF SIDE ROCKER ACTUATOR</b>		
<b>5</b>	6-32 x 0.195 inches	no
<b>E</b>	6-32 x 0.195 inches (multi-pole units only)	yes
<b>6</b>	ISO M3 x 5mm	no
<b>F</b>	ISO M3 x 5mm (multi-pole units only)	yes
<b>PUSH-TO-RESET BEZEL, Threaded Insert, 2 per pole</b>		
<b>3</b>	6-32 x 0.195 inches	no
<b>C</b>	6-32 x 0.195 inches (multi-pole units only)	yes
<b>4</b>	ISO M3 x 5mm	no
<b>D</b>	ISO M3 x 5mm (multi-pole units only)	yes

**11 MAXIMUM APPLICATION RATING**

- M** 80 DC

**12 AGENCY APPROVAL**

- T** UL489A Listed
- J** UL489A Listed, TUV Certified

Notes:

- 1 Push-To-Reset actuators have OFF portion of rocker shrouded.
- 2 Multi-pole breakers have all breakers identical except when specifying Auxiliary switch and/or mixed poles, and have one rocker per breaker.
- 3 Auxiliary Switch breakers with Series Trip circuits: ≤ 30A, are supplied with standard half shells. 30-50A are supplied with extended boat (B-Style) half shells.
- 4 VDE Certification available with single pole breakers only. UL489A Listing available with one and two pole breakers.
- 5 Screw Terminals are recommended on ratings greater than 20 amps. Ratings over 30 amps are only available with Terminal Codes 5, 9, G, H, M and Q.
- 6 Terminal Code 1 (Push-On) available up to 25 amps with TUV or VDE Certification and 30 amps with UL489A Listing, but is not recommended over 20 amps.
- 7 Terminal Codes 3, 5 and H (Bus Type) with TUV or VDE, are supplied with Lock Washers, and Terminal Code M (M6 Threaded Stud) with VDE is supplied with Lock and Flat Washers. These breakers are only TUV or VDE Certified when the washers are used.
- 8 Single pole breakers with Terminal Code P (Printed Circuit Board) are available up to 30 amps with VDE Certification and 50 amps with UL489A Listing.
- 9 Terminal Code Q not available with VDE certification.
- 10 Color shown is Visi and Legend with remainder of rocker black. Dual = ON-OFF/I-O legend.
- 11 Legend on Push-to-reset bezel/shroud is white with single color actuator codes R & U.
- 12 Legend on Push-To-Reset bezel/shroud matches Visi-Color of rocker with actuator codes N & O. Rockerguard available with actuator codes C through K



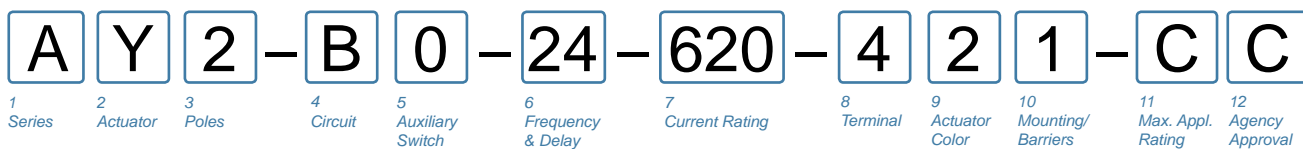

**1 SERIES**  
A

**2 ACTUATOR 1**  
Y Single Color Recessed Paddle Actuator with Vertical Legends

**3 POLES 2**  
1 One                                      2 Two                                      3 Three

**4 CIRCUIT**  
A Switch-Only (No Coil)                      F Relay Trip (Current)  
B Series Trip (Current)                      G Relay Trip (Voltage)  
C Series Trip (Voltage)                      H Dual Coil with Shunt Trip Voltage Coil  
D Shunt Trip (Current)                      K Dual Coil with Shunt Trip Current Coil  
E Shunt Trip (Voltage)

**5 AUXILIARY SWITCH**  
0 without Aux Switch  
1 S.P.D.T. with 0.093 Q.C. Terminals  
2 S.P.D.T. with 0.110 Q.C. Terminals  
3 S.P.D.T. with 0.139 Solder Lug Terminals  
4 S.P.D.T. with 0.110 Q.C. Terminals (Gold Contacts)  
5 S.P.D.T. with 0.093 Q.C. Terminals (Gold Contacts)  
6 S.P.S.T.-N.O. with 0.139 Solder Lug Terminals  
7 S.P.S.T.-N.O. with 0.110 Q.C. Terminals (Gold Contacts)  
8 S.P.S.T.-N.O. with 0.187 Q.C. Terminals  
9 S.P.D.T. with 0.187 Q.C. Terminals

**6 FREQUENCY & DELAY 3**

3	DC, 50/60 Hz Switch Only	22	50/60 Hz Short
10	DC Instantaneous	24	50/60 Hz Medium
11	DC Ultra Short	26	50/60 Hz Long
12	DC Short	42	50/60 Hz Short Hi-Inrush
14	DC Medium	44	50/60 Hz Medium Hi-Inrush
16	DC Long	46	50/60 Hz Long Hi-Inrush
20	50/60 Hz Instantaneous	52	DC, Short, Hi-Inrush
21	50/60 Hz Ultra Short	54	DC, Medium, Hi-Inrush
		56	DC, Long, Hi-Inrush

**7 CURRENT RATING (AMPERES) 4**

<b>CODE</b>	<b>AMPERES</b>				
220	0.200	295	0.950	460	6.000
225	0.250	410	1.000	465	6.500
230	0.300	512	1.250	470	7.000
235	0.350	415	1.500	475	7.500
240	0.400	517	1.750	480	8.000
245	0.450	420	2.000	485	8.500
250	0.500	522	2.250	490	9.000
255	0.550	425	2.500	495	9.500
260	0.600	527	2.750	610	10.000
265	0.650	430	3.000	710	10.500
270	0.700	435	3.500	611	11.000
275	0.750	440	4.000	711	11.500
280	0.800	445	4.500	612	12.000
285	0.850	450	5.000	712	12.500
290	0.900	455	5.500	613	13.000

**OR VOLTAGE COIL (NORMAL RATED VOLTAGE)**

<b>CODE</b>	<b>AMPERES</b>				
A06	6 DC	A32	32 DC	J12	12 AC
A12	12 DC	A48	48 DC	J18	18 AC
A18	18 DC	A65	65 DC	J24	24 AC
A24	24 DC	J06	6 AC	J48	48 AC
				J65	65 AC
				K20	120 AC
				L40	240 AC

**8 TERMINAL**

1	Push-On 0.250 Tab (Q.C.)	C	Screw, M4 with upturned lugs
2	Screw 8-32 with upturned lugs	E	Screw, M4 (Bus Type)
3	Screw 8-32 (Bus Type)	F	Screw M5 with upturned lugs & 30° bend
4	Screw 10-32 with upturned lugs	G	Screw M5 (Bus Type) & 30° bend
5	Screw 10-32 (Bus Type)	H	Screw M5 (Bus Type)
6	Screw 8-32 with upturned lugs & 30° bend	L	0.250 Q.C./Solder Lug
7	Screw 8-32 (Bus Type) & 30° bend	M	M6 Threaded Stud
8	Screw 10-32 with upturned lugs & 30° bend	P	Printed Circuit Board Terminals
9	Screw 10-32 (Bus Type) & 30° bend	Q	Push-In Stud
B	Screw M5 with upturned lugs	R	Screw, M4 with upturned lugs & 30° Bend
		S	Screw, M5 with upturned lugs
		T	Screw, M4 with upturned lugs

**9 ACTUATOR COLOR & LEGEND 5**

Actuator Color	I-O	ON-OFF	Dual	Legend Color
White	A	B	1	Black
Black	C	D	2	White
Red	F	G	3	White
Green	H	J	4	White
Blue	K	L	5	White
Yellow	M	N	6	Black
Gray	P	Q	7	Black
Orange	R	S	8	Black

**10 MOUNTING / BARRIERS**

	BARRIERS	
1	6-32 x 0.195 inches	no
A	6-32 X 0.195 inches (multi-pole units only)	yes
2	ISO M3 x 5mm	no
B	ISO M3 x 5mm (multi-pole units only)	yes

**11 MAXIMUM APPLICATION RATING 6**

A	65 VDC
C	120/240 VAC (Available only on 2 or 3-Pole units)
K	120 VAC
M	80 DC

**12 AGENCY APPROVAL 7**

A	Without Approvals
C	UL Recognized and CSA Accepted
T	UL 489A

Notes:

- All standard catalog numbers are supplied with Vertical Legends. For Horizontal or other non-standard legends, choose "X" and order as a special catalog number.
- For rating (T) 2 & 3 Pole not available.
- Frequency and Time Delay ratings of (03, 20, 21, 22, 24, 26, 42, 44, 46) not available with approval T.
- Voltage Coil Ratings starting with (J, K, or L) not available with approval T.
- "OFF and/or "O" Legends are on Bracket and are only visible when the Paddle Actuator is in the off position.
- Maximum Application Ratings (C & K) not available with approval T.
- Not all approvals are available in all constructions. Consult factory for details.

## Circuit & Terminal Diagrams: in. [mm]

CIRCUIT BREAKER PROFILE	CIRCUIT SCHEMATIC		CIRCUIT CODE	AUX. SWITCH CODE	CIRCUIT SCHEMATIC		CIRCUIT CODE	AUX. SWITCH CODE
	ANSI	IEC			ANSI	IEC		
<b>2 TERMINALS</b> 	<b>SWITCH ONLY (NO COIL)</b> 		A	0	<b>SERIES TRIP</b> 		B C	0
<b>5 TERMINALS</b> 	<b>SWITCH ONLY (NO COIL) WITH AUXILIARY SWITCH (4)</b> 		A	1 4 2 2	<b>SERIES TRIP WITH AUXILIARY SWITCH (4)</b> 		B C	1 4 2 2
<b>3 TERMINALS</b> 	<b>SHUNT TRIP</b> 		D E	0	<b>DUAL COIL; SERIES TRIP CURRENT COIL, SHUNT TRIP VOLTAGE COIL</b> 		H	0
<b>4 TERMINALS</b> 	<b>RELAY TRIP</b> 		F G	0	<b>DUAL COIL; SERIES TRIP CURRENT COIL, RELAY TRIP VOLTAGE COIL</b> 		K	0

TERMINAL DESCRIPTION		DEPTH BEHIND PANEL
MAIN	TAB (Q.C.)	2.370 [60.20]
	SCREW TYPE	2.402 [61.01]
SHUNT, RELAY & DUAL COIL	TAB (Q.C.)	2.577 [65.46]
	SCREW #8-32 W/UPTURNED LUGS	2.734 [69.44]
AUX. SWITCH*	.093 TAB (Q.C.)	2.465 [62.61]
	.110 TAB (Q.C.)	2.559 [65.00]
	SOLDER TYPE	2.340 [59.44]

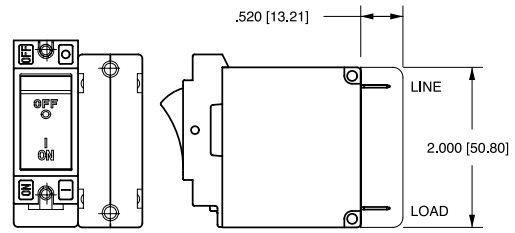

\* AVAILABLE ON SERIES TRIP AND SWITCH ONLY CIRCUITS. WHEN CALLED FOR ON MULTI-POLE UNITS, ONLY ONE AUX. SWITCH IS NORMALLY SUPPLIED, AS VIEWED IN MULTI-POLE IDENTIFICATION SCHEME.

**BARRIER FOR UL-RECOGNIZED MULTI-POLE BREAKERS**

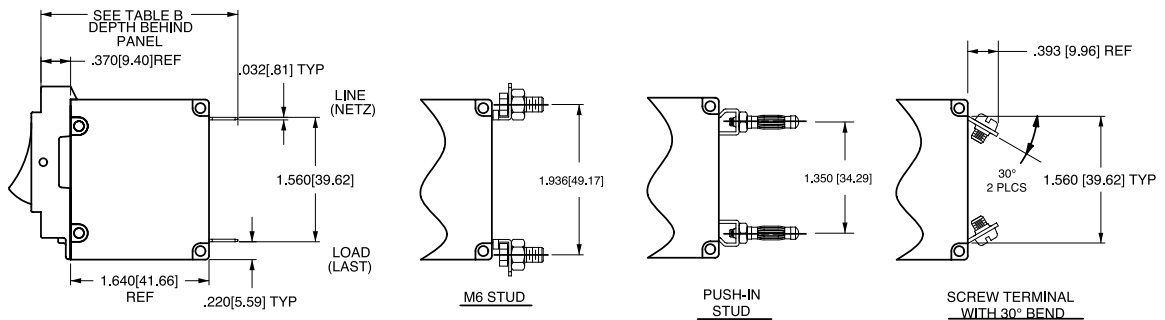

- Notes:
- 1 All dimensions are in inches [millimeters].
  - 2 Tolerance  $\pm .020$  [.51] unless otherwise specified.
  - 3 Schematic shown represents current trip circuit.
  - 4 Circuits shown for >30 amps / VDE.

# Dimensional Specifications: in. [mm]

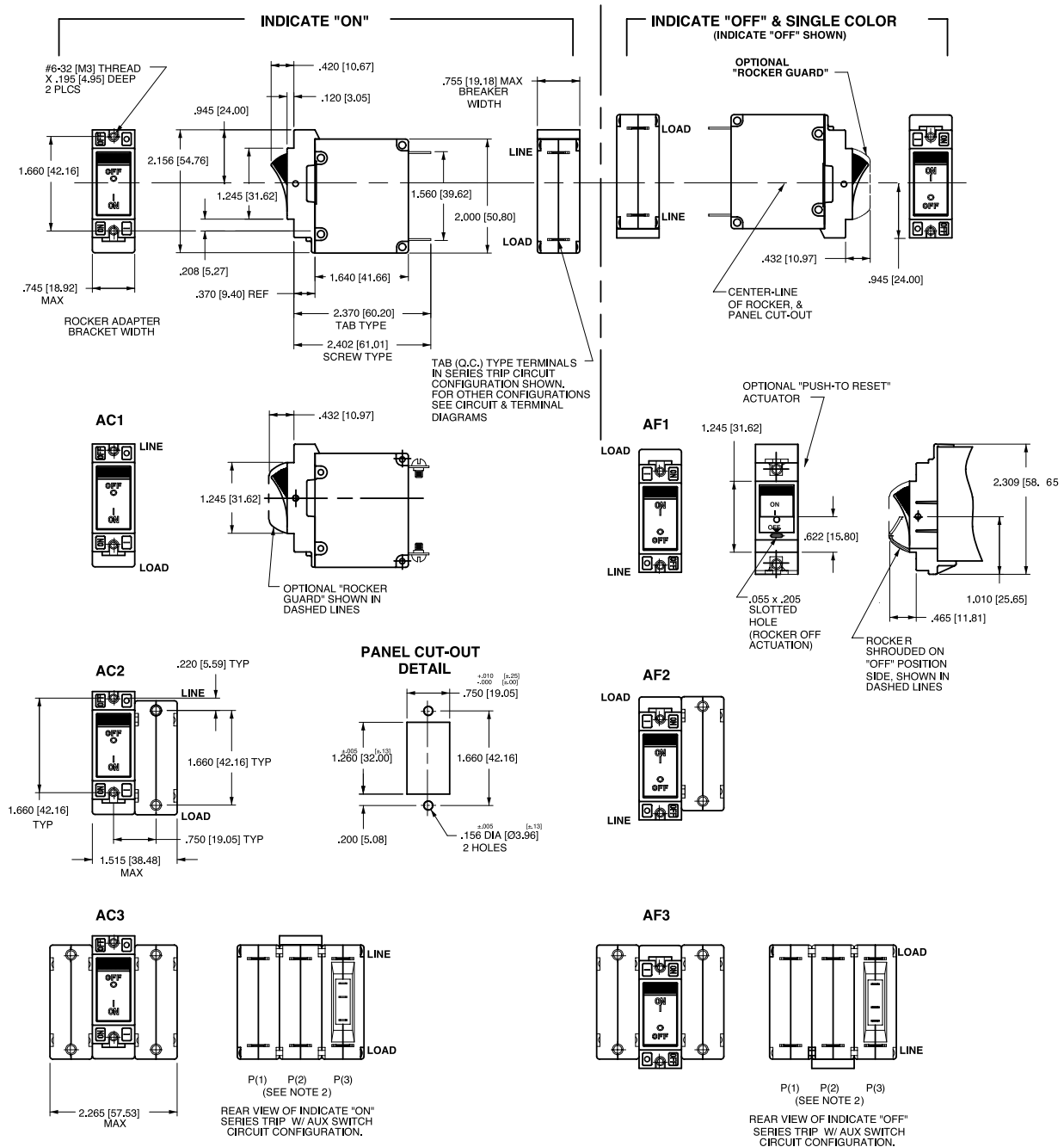

- Notes:
- 1 Dimensions apply to all variations shown. Notice that circuit breaker line & load terminal orientation on indicate OFF is opposite of indicate ON.
  - 2 For pole orientation with horizontal legend, rotate front view clockwise 90°.
  - 3 All dimensions are in inches [millimeters].
  - 4 Tolerance  $\pm 0.20$  [5.1] unless otherwise specified.

## Dimensional Specifications: in. [mm]

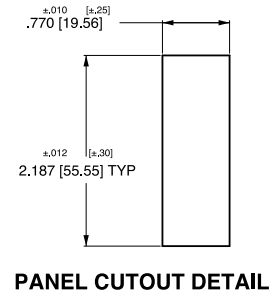
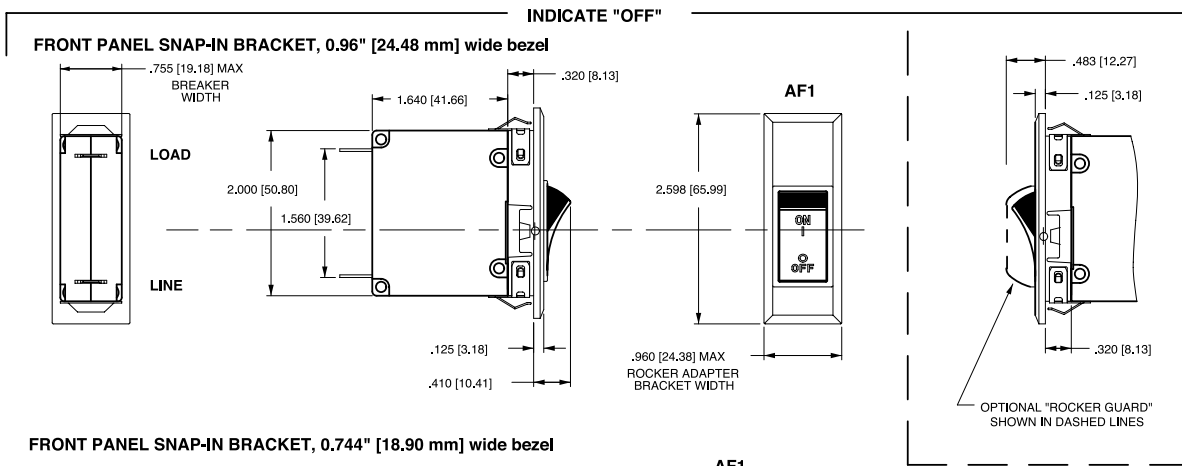
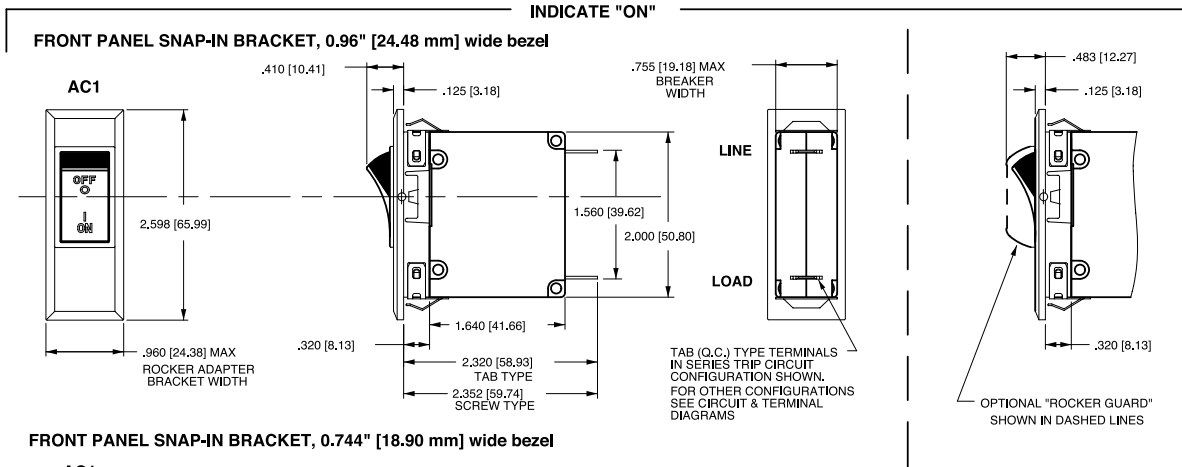

- Notes:
- 1 Dimensions apply to all variations shown. Notice that circuit breaker line & load terminal
  - 2 For pole orientation with horizontal legend, rotate front view clockwise 90°. Orientation on indicate "OFF" is opposite of indicate "ON"
  - 3 Recommended panel thickness: .040 [1.02] to .100 [2.54]
  - 4 All dimensions are in Inches [millimeters].
  - 5 Tolerance  $\pm 0.020$  [ .51] unless otherwise specified.

# Dimensional Specifications: in. [mm]

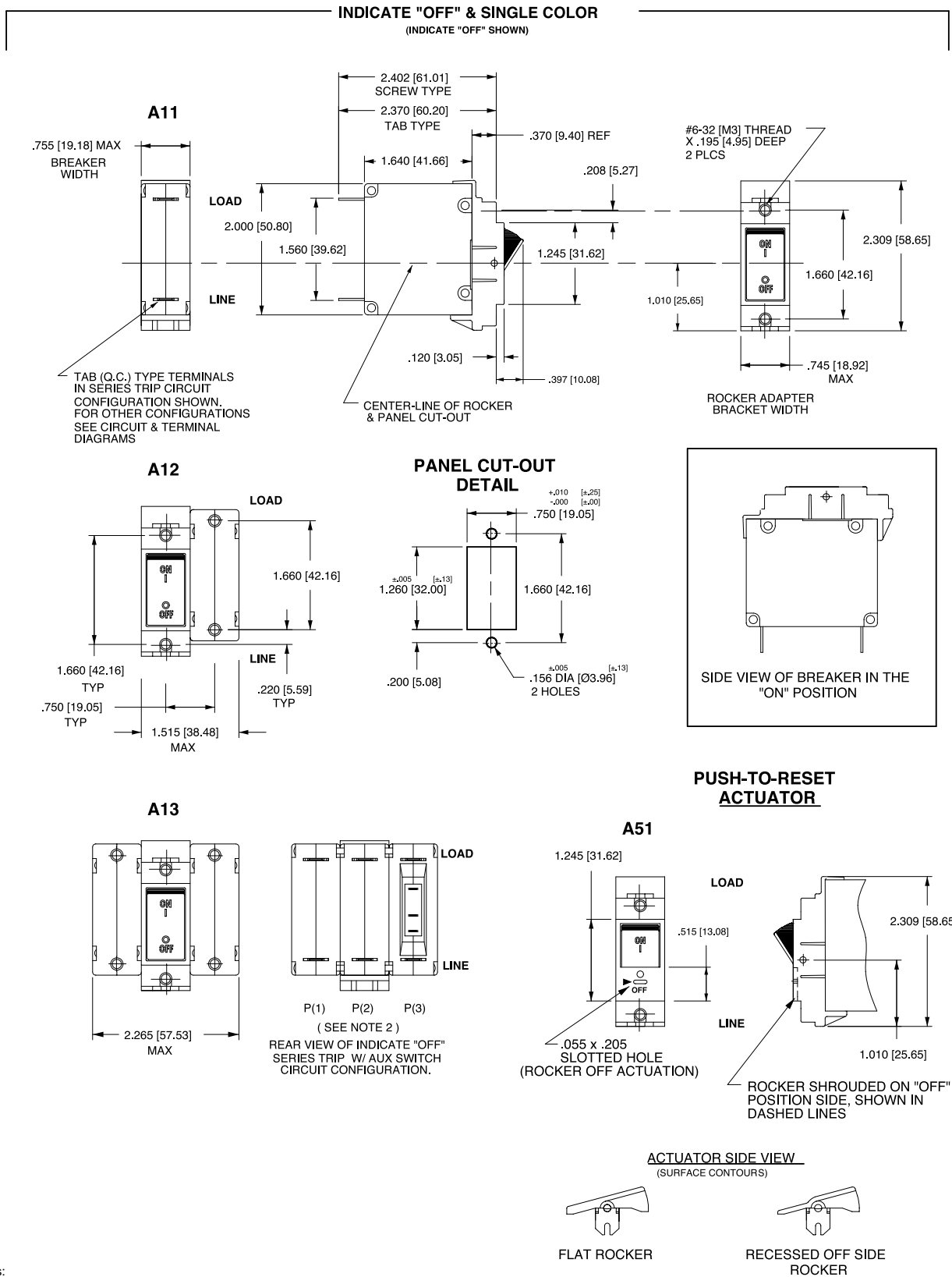

- Notes:  
 1 All dimensions are in inches [millimeters].  
 2 For pole orientation with horizontal legend, rotate front view clockwise 90°.  
 3 Tolerance ± 0.20 [51] unless otherwise specified.

## Dimensional Specifications: in. [mm]

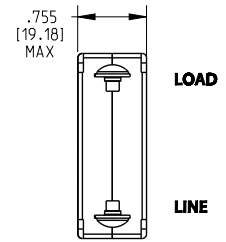
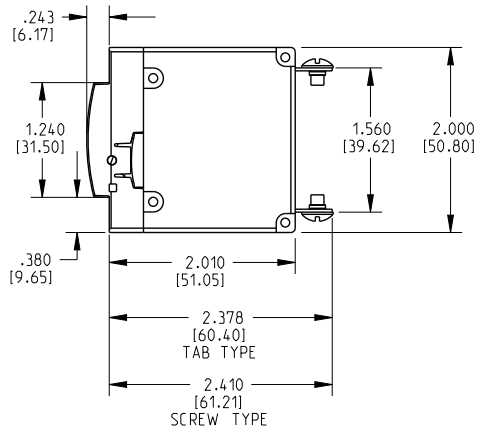
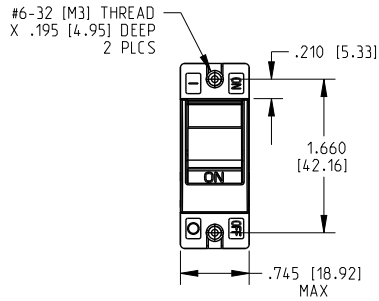

**BREAKER SHOWN IN THE OFF POSITION**

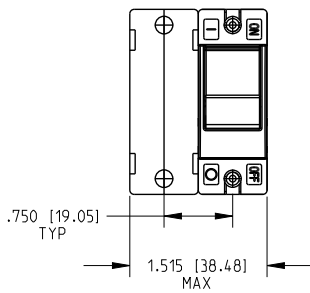

**BREAKER SHOWN IN THE OFF POSITION**

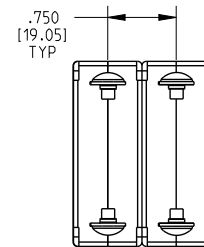
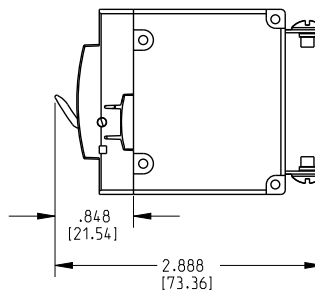

**PANEL CUT-OUT DETAIL**

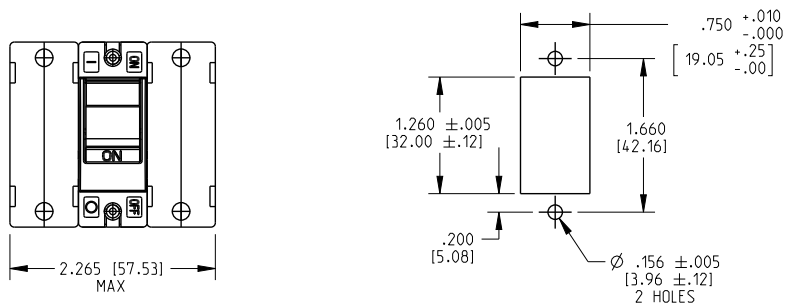

**Notes:**

- 1 All dimensions are in inches [millimeters].
- 2 Tolerance ± 0.20 [51] unless otherwise specified

# PC Terminal Diagrams: in. [mm]

## A-SERIES ROCKER

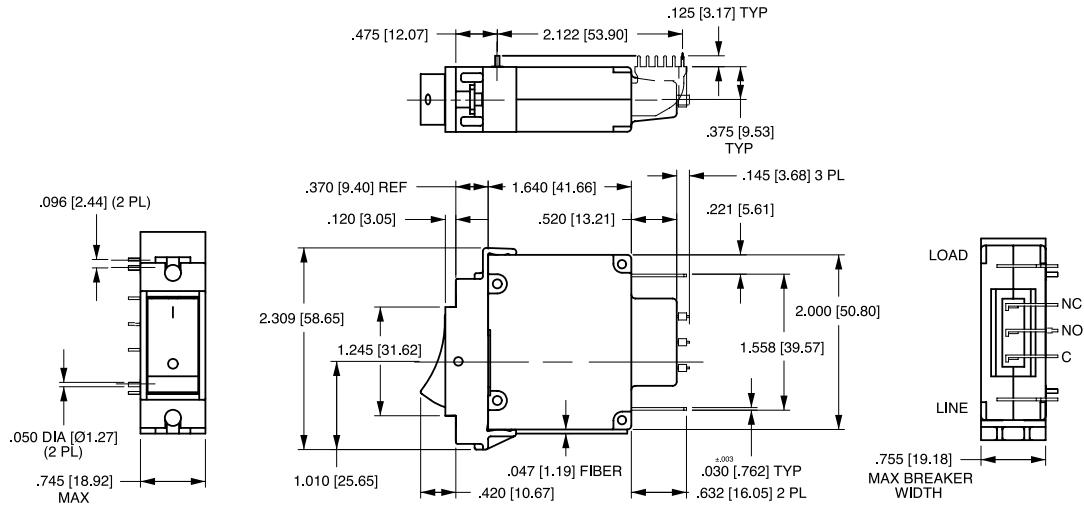

## A-SERIES HANDLE

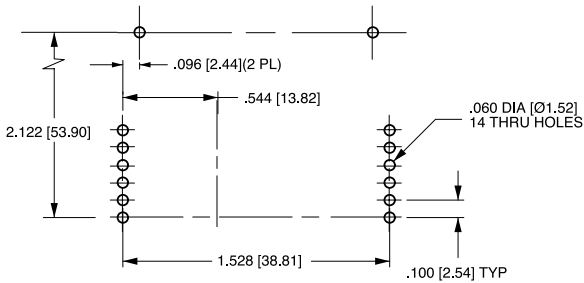
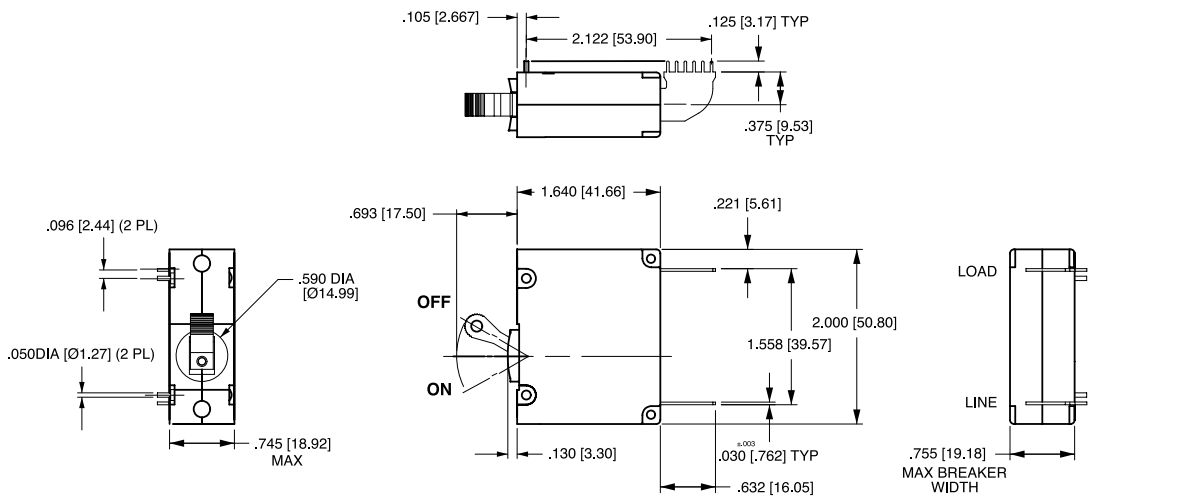

P.C. FOOT PRINT

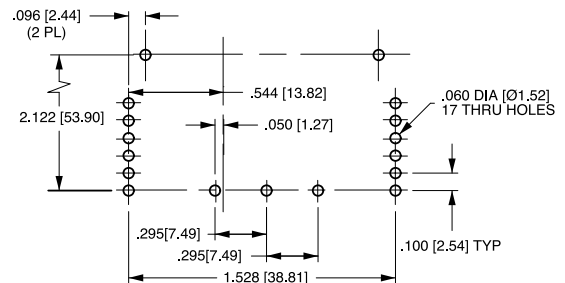

P.C. FOOT PRINT WITH AUX. SWITCH

- Notes:
- 1 Drawing illustrates A-Series with VDE certification.
  - 2 All dimensions are in inches [millimeters].
  - 3 Tolerance  $\pm 0.20$  [.51] unless otherwise specified

# B-Series

## CIRCUIT BREAKER

Carling Technologies' B-Series hydraulic magnetic circuit breakers are specifically designed for applications requiring extra insulation and tongue and groove half-shell constructions. The B-Series carries global regulatory safety approvals for spacing requirements and are ideal for use as general purpose as well as full load amp applications. Available with various choices of time delays, terminals, actuator styles, with a wide range of standard colors and imprinting.

1-6 poles; ratings from 0.02 to 50 amps, up to 277VAC or 80VDC; UL recognized, CSA, VDE -0642, TUV, UL-1500, UL489A Listed



### Product Highlights:

- Meet CSA Standard 22.2 No. 100 for the Generator & Welder markets
- Extra insulation and tongue & groove half-shell constructions
- UL Recognized - UL Standard 508, 1077, 1500
- UL Listed - UL Standard 489, 489A
- CSA Accepted
- TUV Certified
- VDE Certified

Only Marine applicable ordering schemes and drawings are shown in this catalog.  
For complete product details, please visit [www.carlingtech.com](http://www.carlingtech.com)



### Electrical

Maximum Voltage 277VAC 50/60 Hz, 80VDC  
 Current Ratings Standard current coils: 0.100, 0.250, 0.500, 0.750, 1.00, 2.50, 5.00, 7.50, 10.0, 15.0, 20.0, 25.0, 30.0, 35.0, 40.0 and 50.0 amps. Other ratings available, see ordering scheme.  
 Standard Voltage Coils DC - 6V, 12V; AC - 120V, other ratings available, see ordering scheme.  
 Auxiliary Switch Rating SPDT; 10.1 AMPS - 250VAC, 1.0A 65 VDC or 0.5A 80 VDC, 0.1 Amps - 125VAC (with gold contacts). VDE-1.0 Amp - 125VAC.  
 Insulation Resistance Minimum of 100 Megohms at 500 VDC.  
 Dielectric Strength UL, CSA-1500 V 50/60 Hz for one minute between all electrically isolated terminals. B-Series circuit breakers comply with the 8mm spacing and 3750V 50/60 Hz dielectric requirements from hazardous voltage to operator accessible surfaces, between adjacent poles and from main circuits to auxiliary circuits per Publications EN 60950 and VDE 0805.  
 Resistance, Impedance Values from Line to Load Terminal - based on Series Trip Circuit Breaker.

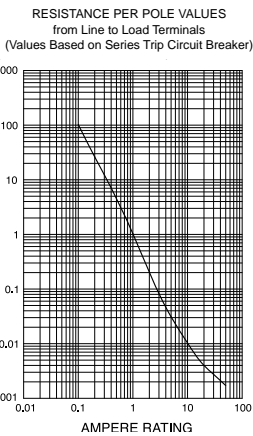

CURRENT (AMPS)	TOLERANCE (%)
0.10 - 5.0	15
5.1 - 20.0	25
20.1 - 50.0	35

### Pulse Tolerance Curves

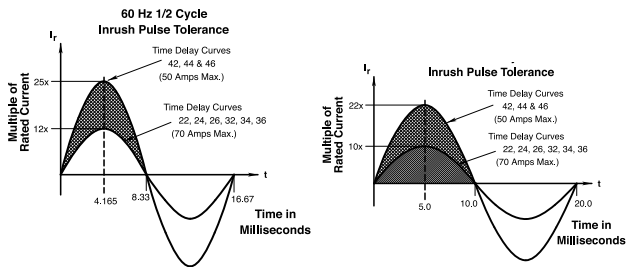

\*Manufacturer reserves the right to change product specification without prior notice.

### Mechanical

Endurance 10,000 ON-OFF operations @ 6 per minute; with rated Current and Voltage.  
 Trip Free All B-Series Circuit Breakers will trip on overload, even when Handle is forcibly held in the ON position.  
 Trip Indication The operating Handle moves positively to the OFF position when an overload causes the breaker to trip.  
 Physical  
 Number of Poles 1 - 6 poles at 30 Amps or less. 1 and 2 poles at 31 Amps thru 50 Amps.  
 Internal Circuit Config. Series, (with or without auxiliary switch), Shunt and Relay with current or voltage trip coils, Dual Coil, Switch Only (with or without auxiliary switch).  
 Weight Approximately 65 grams/pole. (Approximately 2.32 ounces/pole.)  
 Standard Colors Housing- Black; Actuator - See Ordering Scheme.

### Environmental

Designed and tested in accordance with requirements of specification MIL-PRF-55629 & MIL-STD-202 as follows:  
 Shock Withstands 100 Gs, 6ms, sawtooth while carrying rated current per Method 213, Test Condition "I". Instantaneous and ultra-short curves tested @ 90% of rated current.  
 Vibration Withstands 0.060" excursion from 10-55 Hz, and 10 Gs 55-500 Hz, at rated current per Method 204C, Test Condition A. Instantaneous and ultrashort curves tested at 90% of rated current.  
 Moisture Resistance Method 106D, i.e., ten 24-hour cycles @ + 25°C to +65°C, 80-98% RH.  
 Salt Spray Method 101, Condition A (90-95% RH @ 5% NaCl Solution, 96 hrs).  
 Thermal Shock Method 107D, Condition A (Five cycles @ -55°C to +25°C to +85°C to +25°C).  
 Operating Temperature -40° C to +85° C

Electrical Tables

Table A: Lists UL Recognized & CSA Certified configurations and performance capabilities as a Component Supplementary Protector.

B-SERIES TABLE A: COMPONENT SUPPLEMENTARY PROTECTORS										
CIRCUIT CONFIGURATION	VOLTAGE			CURRENT RATING		SHORT CIRCUIT CAPACITY (AMPS)		APPLICATION CODES		CONSTRUCTION NOTES
	MAX. RATING	FREQUENCY	PHASE	FULL LOAD AMPS	GENERAL PURPOSE AMPS	UL/CSA		UL	CSA	
						WITH BACKUP FUSE	WITHOUT BACKUP FUSE			
SERIES	65	DC	--	31 - 50	--	--	7500	TC1,2, OL1,U1	TC1,2, OL1,U1	
	80	DC	--	0.02 - 30	--	--	7500	TC1,2, OL1,U1	TC1,2, OL1,U1	
				---	31 - 50	--	7500	TC1,2, OL0,U1	TC1,2, OL0,U1	
	125	50 / 60	1	1 - 50	--	--	2000	TC1, OL1,U2	TC1, OL1,U2	
	125	50 / 60	1 <sup>4</sup>	1 - 50	--	--	1000	TC1, OL1,U2	TC3, OL1,U3	
	125 / 250	50 / 60	1 <sup>3</sup>	0.02 - 30	--	--	3000	TC1,2, OL1,U1	TC1,2, OL1,U1	
	250	50 / 60	1	0.02 - 30	--	--	1500	TC1, OL0,U2	TC1, OL0,U2	Single Pole Break
				0.02 - 30	--	--	3000	TC1, OL1,U2	TC1, OL1,U2	Two Pole Break
				---	31 - 50	--	3000	TC1,2, OL0,U1	TC1,2, OL0,U1	
			1 <sup>4</sup>	1 - 50	--	1000	TC1, OL1,U2	TC3, OL1,U3		
3			0.02 - 30	--	5000 <sup>2</sup>	--	TC1,2, OL1,C1	TC1,2, OL1,C1		
277	50 / 60	1	0.02 - 30	--	5000 <sup>1</sup>	--	TC1,2, OL1,C1	TC1,2, OL1,C1		
DUAL COIL	65	DC	--	0.02 - 50	--	--	7500	TC1,2, OL1,U1	TC1,2, OL1,U1	
	80	DC	--	0.02 - 30	--	--	7500	TC1,2, OL1,U1	TC1,2, OL1,U1	
				---	31 - 50	--	7500	TC1,2, OL0,U1	TC1,2, OL0,U1	
	125	50 / 60	1	1 - 50	--	--	2000	TC1, OL1,U2	TC1, OL1,U2	
	125 / 250	50 / 60	1 <sup>3</sup>	0.02 - 30	--	--	3000	TC1,2, OL1,U1	TC1,2, OL1,U1	
	250	50 / 60	1	0.02 - 30	--	--	1500	TC1, OL0,U2	TC1, OL0,U2	Single Pole Break
				0.02 - 30	--	--	3000	TC1, OL1,U2	TC1, OL1,U2	Two Pole Break
				---	31 - 50	--	3000	TC1,2, OL0,U1	TC1,2, OL0,U1	
			1 <sup>4</sup>	1 - 50	--	1000	TC1, OL1,U2	TC3, OL1,U3		
			3	0.02 - 30	--	5000 <sup>2</sup>	--	TC1,2, OL1,C1	TC1,2, OL1,C1	
277	50 / 60	1	0.02 - 30	--	5000 <sup>1</sup>	--	TC1,2, OL1,U1	TC1,2, OL1,U1		
SHUNT	80	DC	--	0.02 - 30	--	--	7500	TC1,2, OL1,U1	TC1,2, OL1,U1	
	125 / 250	50 / 60	1 <sup>3</sup>	0.02 - 30	--	--	3000	TC1,2, OL1,U1	TC1,2, OL1,U1	
				---	31 - 50	--	3000	TC1,2, OL1,U1	TC1,2, OL1,U1	
	250	50 / 60	1	0.02 - 30	--	--	3000	TC1,2, OL1,U1	TC1,2, OL1,U1	
	277	50 / 60	1	0.02 - 30	--	5000 <sup>2</sup>	--	TC1,2, OL1,C1	TC1,2, OL1,C1	
3				0.02 - 30	--	5000 <sup>2</sup>	--	TC1,2, OL1,C1	TC1,2, OL1,C1	
RELAY	80	DC	--	0.02 - 30	--	--	7500	TC1,2, OL1,U1	TC1,2, OL1,U1	
	125 / 250	50 / 60	1 <sup>3</sup>	0.02 - 30	--	--	3000	TC1,2, OL1,U1	TC1,2, OL1,U1	
				---	31 - 50	--	3000	TC1,2, OL1,U1	TC1,2, OL1,U1	
	250	50 / 60	1	0.02 - 30	--	--	3000	TC1,2, OL1,U1	TC1,2, OL1,U1	
	277	50 / 60	1	0.02 - 30	--	5000 <sup>2</sup>	--	TC1,2, OL1,C1	TC1,2, OL1,C1	
3				0.02 - 30	--	5000 <sup>2</sup>	--	TC1,2, OL1,C1	TC1,2, OL1,C1	
SWITCH ONLY	65	DC	--	0.02 - 50	--	--	--	--	--	
	80	DC	--	0.02 - 30	--	--	--	--	--	
				---	31 - 50	--	--	--	--	
	250	50 / 60	1	---	31 - 50	--	--	--	--	
3				0.02 - 50	--	--	--	--		
277	50 / 60	1	0.02 - 30	31 - 50	--	--	--	--		

Notes:

- 1 Requires branch circuit backup with a UL LISTED Type K5 or RK5 fuse (15A minimum) at no more than 4 times the rating of the protector.
- 2 Same as note 1, except that backup fuse is limited to 80A maximum.
- 3 2 pole protector required (with one pole per power line) for: 250/125 VAC, 125/250 VAC and 208Y/120 VAC Power Systems. 1 pole protector required for: 125 VAC, 1Ø Power System.
- 4 Satisfies the requirements of clause 11.2.8.2.5 of CSA STD C22.2 No 100 for the use of supplementary protectors with portable generators.

Electrical Tables

**Table B:** Lists UL Recognized, CSA, VDE & TUV Certified configurations & performance capabilities as a Component Supplementary Protector.

B-SERIES TABLE B: COMPONENT SUPPLEMENTARY PROTECTORS																
CIRCUIT CONFIGURATION	VOLTAGE			CURRENT RATING		SHORT CIRCUIT CAPACITY (AMPS)						APPLICATION CODES		CONSTRUCTION NOTES		
	MAX. RATING	FREQUENCY	PHASE	FULL LOAD AMPS	GENERAL PURPOSE AMPS <sup>1</sup>	UL/CSA		VDE		TUV		UL	CSA			
						WITH BACKUP FUSE	WITHOUT BACKUP FUSE	(Inc) WITH BACKUP FUSE	(Inc) WITHOUT BACKUP FUSE	(Inc) WITH BACKUP FUSE	(Inc) WITHOUT BACKUP FUSE					
SERIES	80	DC	---	0.10 - 30	—	—	7500	3000	1500	3000	1500	TC1,2, OL1,U1	TC1,2, OL1,U1			
				31 - 50	31 - 50	—	7500	3000	1500	3000	1500	TC1,2, OL0,U1	TC1,2, OL0,U1			
				0.10 - 30	—	—	7500	3000	1500	3000	1500	TC1,2, OL1,U1	TC1,2, OL1,U1			
				31 - 32	—	—	7500	3000	1500	3000	1500	TC1,2, OL1,U1	TC1,2, OL1,U1			
				31 - 50	31 - 50	—	7500	3000	1500	3000	1500	TC1,2, OL0,U1	TC1,2, OL0,U1			
				0.10 - 30	—	—	3000	3000	1500	5000	1500	TC1,2, OL1,U1	TC1,2, OL1,U1			
	250	50 / 60	1	0.10 - 30	—	—	3000	—	—	5000	1500	TC1,2, OL0,U1	TC1,2, OL0,U1			
				31 - 50	31 - 50	—	3000	—	—	5000	1500	TC1,2, OL0,U1	TC1,2, OL0,U1			
				31 - 32	—	—	3000	6000	1500	5000	1500	TC1,2, OL1,U1	TC1,2, OL1,U1			
				0.10 - 30	—	—	1500	3000	1500	5000	1500	TC1, OL0,U2	TC1, OL0,U2	Single Pole Break		
				0.10 - 30	—	—	3000	3000	1500	5000	1500	TC1, OL1,U2	TC1, OL1,U2	Two Pole Break		
				0.10 - 30	—	—	5000 <sup>3</sup>	—	3000	1500	3000	1500	TC1,2, OL1,C1	TC1,2, OL1,C1		
415	50 / 60	3	0.10 - 30	—	—	1000	3000	1500	3000	1500	TC1,2, OL1,C1	TC1,2, OL1,C1				
DUAL COIL	80	DC	---	0.10 - 30	—	—	7500	3000	1500	3000	1500	TC1,2, OL1,U1	TC1,2, OL1,U1			
				0.10 - 30	—	—	3000	3000	1500	5000	1500	TC1,2, OL1,U1	TC1,2, OL1,U1			
				30 - 50	31 - 50	—	3000	—	—	5000	1500	TC1,2, OL0,U1	TC1,2, OL0,U1			
	250	50 / 60	1	0.10 - 30	—	—	5000 <sup>3</sup>	—	3000	1500	3000	1500	TC1,2, OL1,C1	TC1,2, OL1,C1		
				31 - 50	—	—	2000 <sup>2</sup>	—	—	3000	1500	TC1,2, OL1,C1	TC1,2, OL1,C1			
				3	0.10 - 30	—	—	3000	3000	1500	5000	1500	TC1,2, OL1,U1	TC1,2, OL1,U1		
SHUNT	80	DC	---	0.10 - 30	—	—	7500	3000	1500	3000	1500	TC1,2, OL1,U1	TC1,2, OL1,U1			
				0.10 - 30	—	—	7500	3000	1500	3000	1500	TC1,2, OL1,U1	TC1,2, OL1,U1			
				1	0.10 - 30	—	—	3000	3000	1500	5000	1500	TC1,2, OL1,U1	TC1,2, OL1,U1		
	250	50 / 60	1	30 - 50	31 - 50	—	3000	—	—	5000	1500	TC1,2, OL0,U1	TC1,2, OL0,U1			
				3	0.10 - 30	—	—	5000 <sup>3</sup>	—	3000	1500	3000	1500	TC1,2, OL1,C1	TC1,2, OL1,C1	
				31 - 50	—	—	2000 <sup>2</sup>	—	—	3000	1500	TC1,2, OL1,C1	TC1,2, OL1,C1			

Notes:  
 1 General Purpose Ratings for UL/CSA Only.  
 2 Requires branch circuit backup with a UL LISTED Type K5 or RK5 fuse (15A minimum) at no more than 4 times the rating of the protector.  
 3 Same as note 1, except that backup fuse is limited to 80 A maximum.

**Table C:** Lists UL Recognized, CSA Certified configurations and performance capabilities as Protectors, Supplementary for Marine Electrical and Fuel Systems (CCN/Guide PEQZ2, File E75596). Ignition Protected per UL 1500. UL Classified Small Craft Electrical Devices, Marine in accordance with ISO 8846 (CCN/Guide UZMK, File MQ1515) as Marine Supplementary Protectors.

B-SERIES TABLE C: UL1500 (Marine Ignition Protected)							
CIRCUIT CONFIGURATION	VOLTAGE			CURRENT RATING	SHORT CIRCUIT CAPACITY (AMPS)	APPLICATION CODES	
	MAX. RATING	FREQUENCY	PHASE			UL	CSA
SERIES	14 <sup>1</sup>	DC	—	0.02 - 50	5000	TC1,2,OL1,U1	TC1,2,OL1,U1
	32 <sup>1</sup>	DC	—	0.02 - 50	5000	TC1,2,OL1,U2	TC1,2,OL1,U2
	65	DC	—	0.02 - 50	3000	TC1,2,OL1,U1	TC1,2,OL1,U1
	125 / 250	50 / 60	1 <sup>2</sup>	0.02 - 50	1500	TC1,2,OL1,U1	TC1,2,OL1,U1
	250	50 / 60	1	0.02 - 30	1000	TC1,2,OL1,U1	TC1,2,OL1,U1

Notes:  
 1 Available with special catalog number only (consult factory).  
 2 2 pole protector required (with one pole per power line) for: 250/125 VAC, 125/250 VAC and 208Y/120 VAC Power Systems. 1 pole protector required for: 125 VAC, 1Ø Power System.

**Table D:** Lists UL Listed configurations and performance capabilities as Circuit Breakers for use in Communications Equipment (CCN/ Guide DITT, File E189195), under UL489A

B-SERIES TABLE D: UL489A (COMMUNICATIONS EQUIPMENT)				
CIRCUIT CONFIGURATION	VOLTAGE		CURRENT RATING	INTERRUPTING CAPACITY (AMPS)
	MAX. RATING	FREQUENCY	GENERAL PURPOSE AMPS	WITHOUT BACKUP FUSE
SERIES	80	DC	0.10 - 50	5000
	80	DC	60 - 90 <sup>1</sup>	5000

Notes:  
<sup>1</sup> Parallel Pole Construction

**Table E:** Lists UL Listed (489) configuration and performance capabilities as a Molded Case Circuit Breaker.

B SERIES TABLE E : UL489 LISTED BRANCH CIRCUIT BREAKERS						
CIRCUIT CONFIGURATION	VOLTAGE			CURRENT RATING	INTERRUPTING CAPACITY (AMPS)	CONSTRUCTION NOTES
	MAX. RATING	FREQUENCY	PHASE	FULL LOAD AMPS	WITHOUT BACKUP FUSE	
SERIES	120	50 / 60	1	0.10 - 30	5,000	1 Pole
	120 / 240	50 / 60	1	0.10 - 30	5,000	2 Poles
	120 / 240	50 / 60	1	0.10 - 30	5,000	2 or 3 Poles (1 Pole of a 3 Pole Unit is for Neutral Break)
SHUNT TRIP DUAL COIL	120	50 / 60	1	0.10 - 30	5,000	1 Pole
	120 / 240	50 / 60	1	0.10 - 30	5,000	2 Poles
	120 / 240	50 / 60	1	0.10 - 30	5,000	2 or 3 Poles (1 Pole of a 3 Pole Unit is for Neutral Break)

### Agency Certifications

**UL Recognized**

UL Standard 1077



Component Recognition Program as Protectors Supplementary (Guide CCN/QVNU2, File E75596)

**CSA Accepted**



Component Supplementary Protector under Class 3215 30, File 047848 0 000 CSA Standard C22.2 No. 235

UL Standard 508



Switches, Industrial Control (Guide CCN/NRNT2, File E148683)

**TUV Certified**



EN60934, under License No. R72103448

UL Standard 1500



Protectors, Supplementary for Marine Electrical & Fuel Systems (Guide PEQZ2, File E75596) Ignition Protection

**VDE Certified**



EN60934, VDE 0642 under File No. 10537

**UL Listed**

UL Standard 489



Circuit Breakers, Molded Case, (Guide DIVQ, File E129899)

UL Standard 489A

Communications Equipment (Guide CCN/DITT, File E189195)

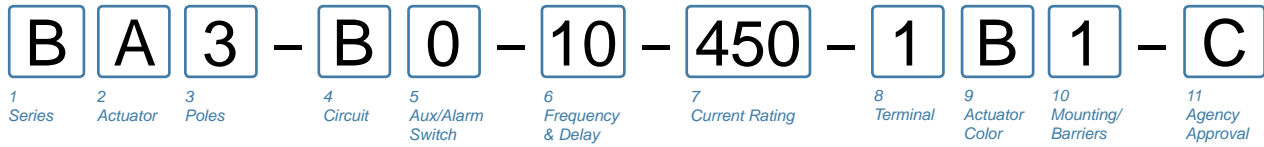

**1 SERIES**

**B**

**2 ACTUATOR**

- A** Handle, one per pole
- B** Handle, one per multipole unit
- S** Mid-Trip Handle, one per pole
- T** Mid-Trip Handle, one per pole & Alarm Switch

**3 POLES**

- 1** One
- 2** Two
- 3** Three
- 4** Four
- 5** Five
- 6** Six

**4 CIRCUIT**

- A**<sup>2</sup> Switch Only (No Coil)
- B** Series Trip (Current)
- C** Series Trip (Voltage)
- D**<sup>3</sup> Shunt Trip (Current)
- E**<sup>3</sup> Shunt Trip (Voltage)
- F**<sup>3</sup> Relay Trip (Current)
- G**<sup>3</sup> Relay Trip (Voltage)
- H**<sup>3,4</sup> Dual Coil with Shunt Trip Voltage Coil
- K**<sup>3,4</sup> Dual Coil with Relay Trip Voltage Coil

**5 AUXILIARY / ALARM SWITCH**<sup>5</sup>

- 0** without Aux Switch
- 1** S.P.D.T., 0.093 Q.C. Term.
- 2** S.P.D.T., 0.110 Q.C. Term.
- 4** S.P.D.T., 0.110 Q.C. Term. (Gold Contacts)
- 5** S.P.S.T., 0.093 Q.C. Term. (Gold Contacts)
- 7** S.P.S.T., 0.110 Q.C. Term. (Gold Contacts)
- 8** S.P.S.T., 0.187 Q.C. Term.
- 9** S.P.D.T., 0.187 Q.C. Term.

**6 FREQUENCY & DELAY**

- 03**<sup>2</sup> DC 50/60Hz, Switch Only
- 10**<sup>6</sup> DC Instantaneous
- 11** DC Ultra Short
- 12** DC Short
- 14** DC Medium
- 16** DC Long
- 20**<sup>6</sup> 50/60Hz Instantaneous
- 21** 50/60Hz Ultra Short
- 22** 50/60Hz Short
- 24** 50/60Hz Medium
- 26** 50/60Hz Long
- 30** DC, 50/60Hz Instantaneous
- 31** DC, 50/60Hz Ultra Short
- 32** DC, 50/60Hz Short
- 34** DC, 50/60Hz Medium
- 36** DC, 50/60Hz Long
- 42**<sup>7</sup> 50/60Hz Short, Hi-Inrush
- 44**<sup>7</sup> 50/60Hz Medium, Hi-Inrush
- 46**<sup>7</sup> 50/60Hz Long, Hi-Inrush
- 52**<sup>7</sup> DC, Short, Hi-Inrush
- 54**<sup>7</sup> DC, Medium, Hi-Inrush
- 56**<sup>7</sup> DC, Long, Hi-Inrush

**7 CURRENT RATING (AMPERES)**

CODE	AMPERES				
020	0.020	225	0.250	420	2.000
025	0.025	230	0.300	522	2.250
030	0.030	235	0.350	527	2.750
035	0.035	240	0.400	430	3.000
040	0.040	245	0.450	435	3.500
045	0.045	250	0.500	440	4.000
050	0.050	255	0.550	445	4.500
055	0.055	260	0.600	450	5.000
060	0.060	265	0.650	455	5.500
065	0.065	270	0.700	460	6.000
070	0.070	275	0.750	465	6.500
075	0.075	280	0.800	470	7.000
080	0.080	285	0.850	475	7.500
085	0.085	290	0.900	480	8.000
090	0.090	295	0.950	485	8.500
095	0.095	410	1.000	490	9.000
210	0.100	512	1.250	495	9.500
215	0.150	415	1.500	610	10.000
220	0.200	517	1.750	710	10.500

**OR VOLTAGE COIL (NORMAL RATED VOLTAGE)**<sup>6</sup>

CODE	AMPERES				
A06	6 DC	A32	32 DC	J12	12 AC
A12	12 DC	A48	48 DC	J18	18 AC
A18	18 DC	A65	65 DC	J24	24 AC
A24	24 DC	J06	6 AC	J48	48 AC
				J65	65 AC
				K20	120 AC
				L40	240 AC

**8 TERMINAL**<sup>9</sup>

- 1**<sup>10</sup> Push-On 0.250 Tab (Q.C.)
- 2** Screw 8-32 with upturned lugs
- 3**<sup>11</sup> Screw 8-32 (Bus Type)
- 4** Screw 10-32 with upturned lugs
- 5**<sup>11</sup> Screw 10-32 (Bus Type)
- 6** Screw 8-32 with upturned lugs & 30° bend
- 7** Screw 8-32 (Bus Type) & 30° bend
- 8** Screw 10-32 with upturned lugs & 30° bend
- 9** Screw 10-32 (Bus Type) & 30° bend
- B** Screw M5 with upturned lugs
- C** Screw M4 with upturned lugs
- E**<sup>11</sup> Screw M4 (Bus Type)
- F** Screw M5 with upturned lugs & 30° bend
- G** Screw M5 (Bus Type) & 30° bend
- H** Screw M5 (Bus Type)
- J** Screw M5 Back Connect
- K** Screw 10-32 Back Connect
- L**<sup>12</sup> 0.250 Q.C./ Solder Lug
- M**<sup>11</sup> M6 Threaded Stud
- N** Screw M4 Back Connect
- P**<sup>13</sup> Printed Circuit Board Terminals
- Q**<sup>16</sup> Push-In Stud
- R** Screw M4 with upturned lugs & 30° bend
- S**<sup>15</sup> Push-On 0.110 Tab (Q.C.) & 30° bend
- T** Screw M4 (Bus Type) & 30° bend
- Y** Screw 8-32 Back Connect

**9 ACTUATOR COLOR & LEGEND**

Actuator Color	I-O	ON-OFF	Dual	Legend Color
White	A	B	1	Black
Black	C	D	2	White
Red	F	G	3	White
Green	H	J	4	White
Blue	K	L	5	White
Yellow	M	N	6	Black
Gray	P	Q	7	Black
Orange	R	S	8	Black

**10 MOUNTING / BARRIERS**

MOUNTING STYLE	BARRIERS
<b>Threaded Insert, 2 per pole</b>	
<b>1</b> 6-32 x 0.195 inches	no
<b>A</b> 6-32 x 0.195 inches (multi-pole units only)	yes
<b>2</b> ISO M3 x 5mm	no
<b>B</b> ISO M3 x 5mm	yes
<b>Rectangular Adapter Plate with mounting centers of 2.062 inches [52.37mm] and Threaded insert, 2 per pole</b>	
<b>3</b> <sup>14</sup> 6-32 x 0.225 inches	no
<b>C</b> <sup>14</sup> 6-32 X 0.225 inches (multi-pole units only)	yes
<b>4</b> <sup>14</sup> ISO M3 x 6.5mm	no
<b>D</b> <sup>14</sup> ISO M3 x 6.5mm	yes
<b>Front panel Snap-In, 0.75" [19.05mm] wide bezel</b>	
<b>5</b> without Handleguard	no
<b>6</b> without Handleguard (multipole only)	yes
<b>Front panel Snap-In, 0.96" wide bezel</b>	
<b>7</b> without Handleguard, 1-pole 0.96" wide;	no
<b>8</b> multipole units have .105" bezel overhang on all sides without Handleguard, 1-pole 0.96" wide;	yes
(multipole only) .105" bezel overhang on all sides	

**11 AGENCY APPROVAL**

- C** UL Recognized & CSA Accepted
- D** VDE Certified, UL Recognized & CSA Accepted
- E** TUV Certified, UL Recognized & CSA Accepted
- I** UL Recognized STD 1077, UL Recognized 1500 (ignition protected), & CSA Accepted

Notes:

- 1 Actuator Code:
  - A: Handle tie pin spacer(s) and retainers provided unassembled with multi-pole units.
  - B: Handle location as viewed from front of breaker:
    - 2 pole - left pole
    - 3 pole - center pole
    - 4 pole - two handles at center poles
    - 5 pole - three handles at center poles
    - 6 pole - four handles at center poles
  - S: Handle moves to mid-position only upon electrical trip of the breaker. Available with circuit codes B, C, D, E, F, G, H and K.
  - T: Handle moves to mid-position and alarm switch activates only upon electrical trip of the breaker. Available with circuit codes B & C.
- 2 Switch Only circuits, rated up to 50 amps and 6 poles, and only available with VDE Certification when tied to a protected pole (Circuit Code B, C, D or H.). For .02 to 30 amps, select Current Code 630. For 35 - 50 amps, select Current Code 650.
- 3 Available with Terminal Codes 1, 2 and 3. Current Rating limited to 30 amps maximum.
- 4 Consult factory for available Dual Coil options, as special catalog number is required. With Shunt construction, Dual Coils will trip instantaneously on line voltage. Dual coils require 30VA minimum power to trip and are rated for intermittent duty only.
- 5 Auxiliary Switch breakers with Series Trip and Switch Only circuits. On multi-pole breakers, one auxiliary switch is supplied, mounted in the extreme right pole.
- 6 Separate pole type voltage coils not rated for continuous duty. Available only with delay codes 10 and 20.
- 7 Available with Circuit Codes B & D only. VDE Certified to 30 amps. UL Recognized and CSA Accepted to 50 amps.
- 8 VDE Certification available with single pole breakers with DC Delay only. UL Recognition and CSA Accepted available in one and two pole breakers.
- 9 Screw Terminals are recommended on ratings greater than 20 amps. Ratings over 30 amps are only available with Terminal Codes 5, 9, G, H, J, K, M and Q.
- 10 VDE Certification up to 25 amps and UL Recognition and CSA Acceptance up to 30 amps, but not recommended over 20 amps.
- 11 Terminal Codes 3, 5 E and H (Bus Type) with VDE, are supplied with Lock Washers, and Terminal Code M (M6 Threaded Stud) with VDE is supplied with Lock and Flat Washers. These breakers are only VDE Certified when the washers are used.
- 12 VDE Cert. available up to 12 amps. UL Rec. & CSA Acceptance available up to 30 amps.
- 13 Single pole breakers with Terminal Code P (Printed Circuit Board) are available up to 30 amps with VDE Certification and 50 amps with UL Recognition and CSA Acceptance, with Circuit Codes A, B and C. Two pole breakers with Terminal Code P (Printed Circuit Board) are available up to 40 amps with UL Recognition and CSA Acceptance with Circuit Codes A, B and C.
- 14 Available with Actuator Codes A, S and T.
- 15 Available with voltage coils only.
- 16 Terminal Code Q not available with VDE approvals.

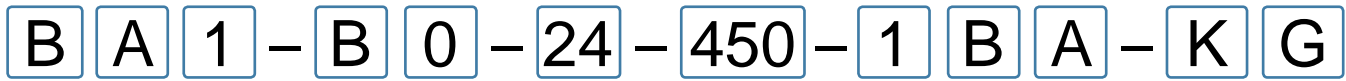

1 Series    2 Actuator    3 Poles    4 Circuit    5 Aux/Alarm Switch    6 Frequency & Delay    7 Current Rating    8 Terminal    9 Actuator Color    10 Mounting/Barriers    11 Max. Appl. Rating    12 Agency Approval

**1 SERIES**  
B

**2 ACTUATOR <sup>1</sup>**  
**A** Handle, one per pole  
**B** Handle, one per multipole unit  
**S** Mid-Trip Handle, one per pole  
**T** Mid-Trip Handle, one per pole & Alarm Switch

**3 POLES <sup>2</sup>**  
**1** One                      **2** Two                      **3** <sup>3</sup> Three

**4 CIRCUIT**  
**B** Series Trip (Current)

**5 AUXILIARY / ALARM SWITCH <sup>4</sup>**  
**0** without Aux Switch                      **3** S.P.D.T., 0.110 Solder Lug  
**1** S.P.D.T., 0.093 Q.C. Term.              **8** S.P.S.T., 0.187 Q.C. Term.  
**2** S.P.D.T., 0.110 Q.C. Term.              **9** S.P.D.T., 0.187 Q.C. Term.

**6 FREQUENCY & DELAY**  
**21** AC Ultra Short                      **42** AC, Short, Hi-Inrush  
**22** AC Short                              **44** AC, Medium, Hi-Inrush  
**24** AC Medium                          **46** AC, Long, Hi-Inrush  
**26** AC Long

**7 CURRENT RATING (AMPERES)**

CODE	AMPERES				
210	0.100	280	0.800	445	4.500
215	0.150	285	0.850	450	5.000
220	0.200	290	0.900	455	5.500
225	0.250	295	0.950	460	6.000
230	0.300	410	1.000	465	6.500
235	0.350	512	1.250	470	7.000
240	0.400	415	1.500	475	7.500
245	0.450	517	1.750	480	8.000
250	0.500	420	2.000	485	8.500
255	0.550	522	2.250	490	9.000
260	0.600	527	2.750	495	9.500
265	0.650	430	3.000	610	10.000
270	0.700	435	3.500	710	10.500
275	0.750	440	4.000	611	11.000
				630	30.000

**8 TERMINAL <sup>4</sup>**

<b>1</b>	Push-On 0.250 Tab (Q.C.)	<b>A</b>	Load Terminal #8 Screw with QC Combination (Special Catalog #)
<b>2</b>	Screw 8-32 with upturned lugs	<b>B</b>	Screw M5 with upturned lugs & 30° bend
<b>3</b>	Screw 8-32 (Bus Type)	<b>F</b>	Screw M5 with upturned lugs & 30° bend
<b>4</b>	Screw 10-32 with upturned lugs	<b>G</b>	Screw M5 (Bus Type) & 30° bend
<b>5</b>	Screw 10-32 (Bus Type)	<b>H</b>	Screw M5 (Bus Type)
<b>6</b>	Screw 8-32 with upturned lugs & 30° bend	<b>J</b>	Screw M5 Back Connect
<b>7</b>	Screw 8-32 (Bus Type) & 30° bend	<b>K</b>	Screw 10-32 Back Connect
<b>8</b>	Screw 10-32 with upturned lugs & 30° bend	<b>M</b>	M6 Threaded Stud
<b>9</b>	Screw 10-32 (Bus Type) & 30° bend	<b>N</b>	Screw M4 Back Connect
		<b>Q</b>	Push-In Stud
		<b>Y</b>	Screw 8-32 Back Connect

**9 ACTUATOR COLOR & LEGEND <sup>6</sup>**

Actuator Color	ON-OFF	Dual	Legend Color
White	<b>B</b>	<b>1</b>	Black
Black	<b>D</b>	<b>2</b>	White
Red	<b>G</b>	<b>3</b>	White
Green	<b>J</b>	<b>4</b>	White
Blue	<b>L</b>	<b>5</b>	White
Yellow	<b>N</b>	<b>6</b>	Black
Gray	<b>Q</b>	<b>7</b>	Black
Orange	<b>S</b>	<b>8</b>	Black

**10 MOUNTING / BARRIERS**

MOUNTING STYLE	BARRIERS
<b>A</b> 6-32 x 0.195 inches (multi-pole units only)	yes
<b>B</b> ISO M3 x 5mm	yes
<b>Rectangular Adapter Plate with mounting centers of 2.062 inches [52.37mm] and Threaded insert, 2 per pole <sup>7</sup></b>	
<b>C</b> 6-32 X 0.225 inches (multi-pole units only)	yes
<b>D</b> ISO M3 x 6.5mm	yes
<b>6</b> Front panel Snap-In, 0.75" [19.05mm] wide bezel without Handleguard (multipole only)	yes
<b>8</b> Front panel Snap-In, 0.96" wide bezel without Handleguard, 1-pole 0.96" wide; (multipole only) .105" bezel overhang on all sides	yes



**11 MAXIMUM APPLICATION RATING**  
**C** <sup>8</sup> 120/240VAC  
**K** 120VAC

**12 AGENCY APPROVAL**  
**G** UL489 Listed  
**3** UL489 Listed, TUV Certified

Notes:  
<sup>1</sup> Actuator Code:  
 A: Handle tie pin spacer(s) and retainers provided un-assembled with multi-pole units.  
 B: Handle location as viewed from front of breaker:  
     2 pole - left pole                      3 pole - center pole  
 S: Handle moves to mid-position only upon electrical trip of the breaker. Available with circuit codes B, C, D, E, F, G, H and K.  
 T: Handle moves to mid-position and alarm switch activates only upon electrical trip of the breaker. Available with circuit codes B & C.  
<sup>2</sup> All poles must be same polarity.  
<sup>3</sup> 3 pole units available only when 1 of 3 poles is neutral.  
<sup>4</sup> Auxiliary/Alarm Switch circuit must be same polarity as the main circuit. On multi-pole breakers, one auxiliary switch is supplied, mounted in the extreme right pole.  
<sup>5</sup> Screw Terminals are recommended on ratings greater than 20 amps.  
<sup>6</sup> Standard actuator colors are black and white.  
<sup>7</sup> Adapter plate with mounting centers of 2.082 inches. Available with Actuator Codes A, S and T.  
<sup>8</sup> Voltage Rating available with 2 and 3-pole breakers only.  
<sup>9</sup> Barriers supplied on multi-pole units only.

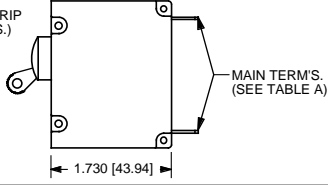
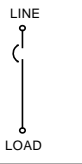
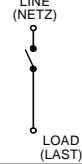
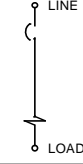
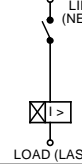
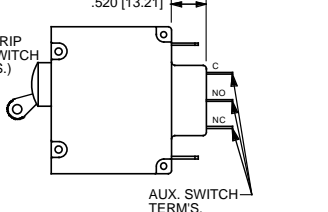
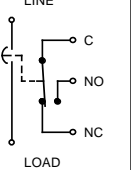
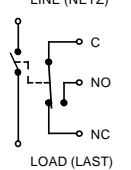
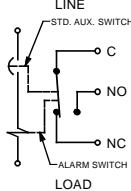
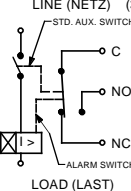
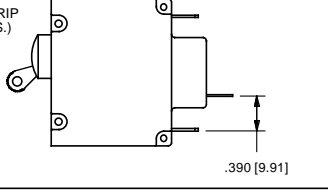
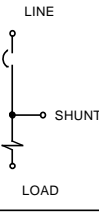
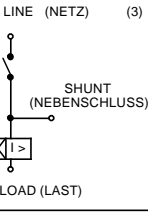
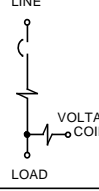
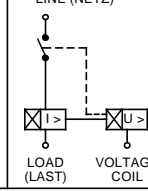
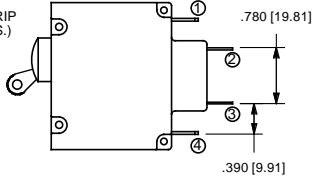
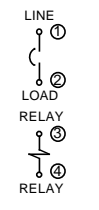
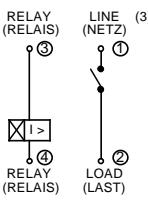
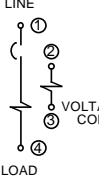
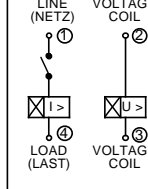
### Circuit & Terminal Diagrams: in. [mm]

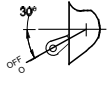
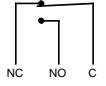
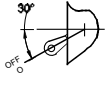
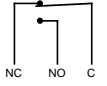
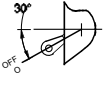
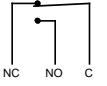
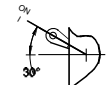
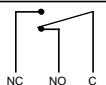
	CIRCUIT SCHEMATIC		CIRCUIT CODE	SWITCH CODE	CIRCUIT SCHEMATIC		CIRCUIT CODE	AUX. SWITCH CODE
	ANSI	IEC			ANSI	IEC		
<b>SERIES TRIP (2 TERM.S.)</b> 	<b>SWITCH ONLY (NO COIL)</b>  		A	O	<b>SERIES TRIP</b>  		B C	O
<b>SERIES TRIP W AUX SWITCH (5 TERM.S.)</b> 	<b>SWITCH ONLY (NO COIL) WITH AUXILIARY SWITCH</b>  		A	2 3 4	<b>SERIES TRIP WITH AUXILIARY / ALARM SWITCH</b>  		B C	2 3 4
<b>SHUNT TRIP (3 TERM.S.)</b> 	<b>SHUNT TRIP</b>  		D E	0	<b>DUAL COIL; SERIES TRIP CURRENT COIL, SHUNT TRIP VOLTAGE COIL</b>  		H	0
<b>RELAY TRIP (4 TERM.S.)</b> 	<b>RELAY TRIP</b>  		F G	0	<b>DUAL COIL; SERIES TRIP CURRENT COIL, RELAY TRIP VOLTAGE COIL</b>  		K	0

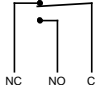
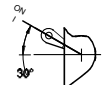
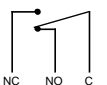
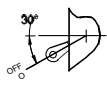
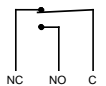
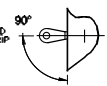
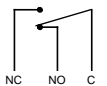
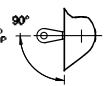
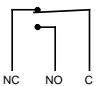
CIRCUIT BREAKER MODE	STANDARD C/B		MID TRIP C/B		MID TRIP C/B	
	HANDLE POSITION	AUX. SWITCH MODE	HANDLE POSITION	ALARM SWITCH MODE	HANDLE POSITION	AUX. SWITCH MODE (w/o ALARM SWITCH)
OFF						
ON						
ELECTRICAL TRIP						

Notes:  
 1 All dimensions are in inches [millimeters].  
 2 Tolerance ±.020 [.51] unless otherwise specified.  
 3 Alarm Switch available with .110 x .020 Q.C. & Solder Lug Terminals Only.

## Circuit & Terminal Diagrams: in. [mm]

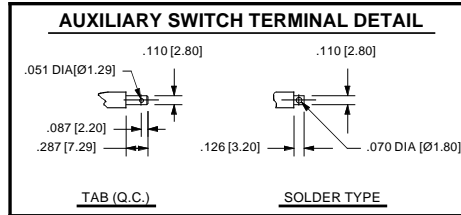
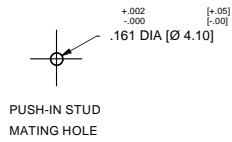
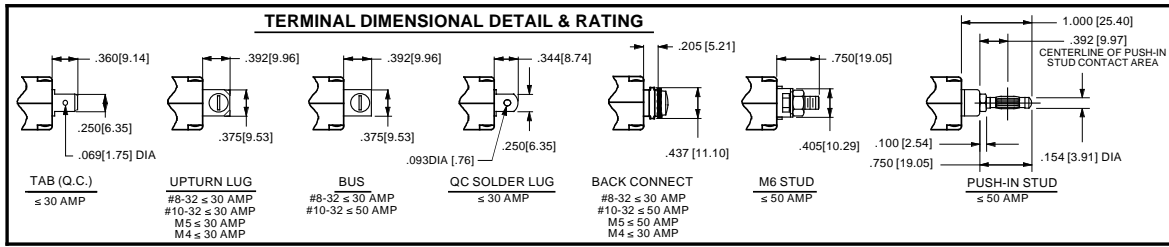

**TABLE A  
TIGHTENING TORQUE SPECIFICATIONS**

THREAD SIZE	TORQUE
#6-32 & M3 MOUNTING HARDWARE	7-9 IN-LBS [0.8-1.0 NM]
#8-32 & M4 THREAD TERMINAL SCREW	12-15 IN-LBS [1.4-1.7 NM]
#10-32 & M5 THREAD TERMINAL SCREW	15-20 IN-LBS [1.7-2.3 NM]

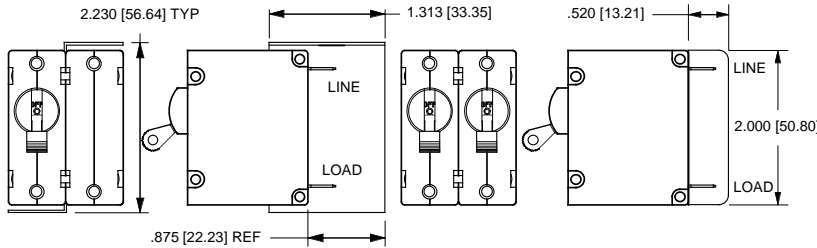

**BARRIER FOR UL-489 MULTI-POLE BREAKERS**

**BARRIER FOR UL-RECOGNIZED MULTI-POLE BREAKERS**

**TABLE B**

TERMINAL DESCRIPTION	DEPTH BEHIND PANEL
MAIN TAB (Q.C.)	2.090 [53.09]
MAIN SCREW TYPE	2.122 [53.90]
SHUNT, RELAY & DUAL COIL TAB (Q.C.)	2.612 [66.35]
SHUNT, RELAY & DUAL COIL SCREW #8-32 W/UPTURNED LUGS	2.644 [67.16]
AUX. SWITCH* TAB (Q.C.) .110 x .020	2.537 [64.44]
AUX. SWITCH* SOLDER TYPE	2.348 [59.64]

\* AVAILABLE ON SERIES TRIP AND SWITCH ONLY CIRCUITS. WHEN CALLED FOR ON MULTI-POLE UNITS, ONLY ONE AUX. SWITCH IS NORMALLY SUPPLIED, AS SHOWN IN MULTI-POLE IDENTIFICATION SCHEME.

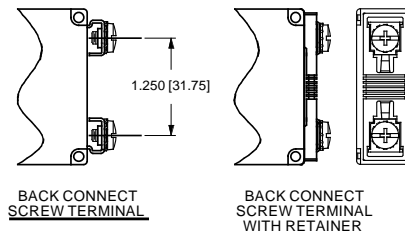
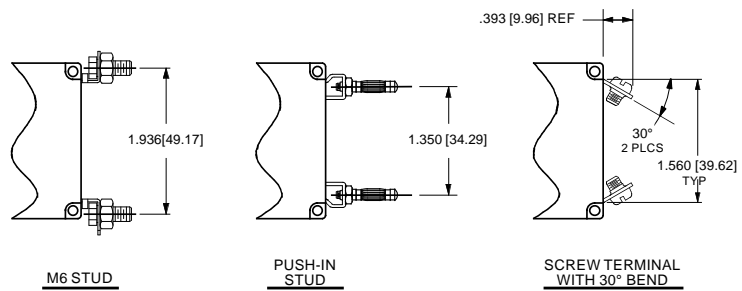
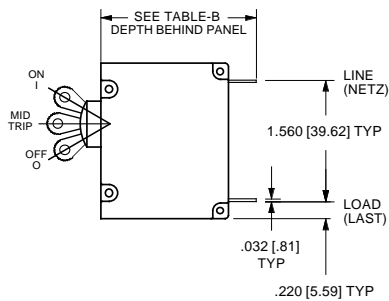

Notes:  
 1 All dimensions are in inches [millimeters].  
 2 Tolerance ±.020 [.51] unless otherwise specified.



## Dimensional Specifications: in. [mm]

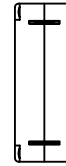
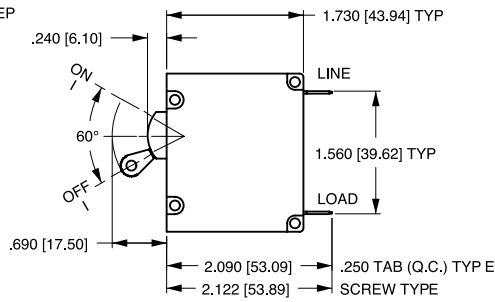
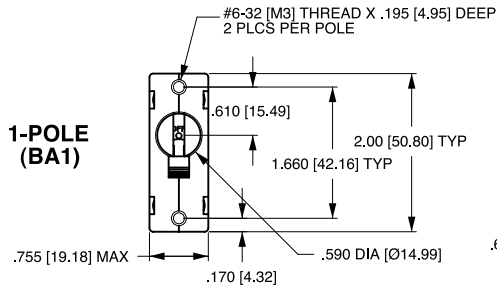

TAB (Q.C.) TYPE TERMINALS  
IN SERIES TRIP CIRCUIT  
CONFIGURATION SHOWN.  
FOR OTHER CONFIGURATIONS,  
SEE CIRCUIT AND TERMINAL  
DRAWINGS.

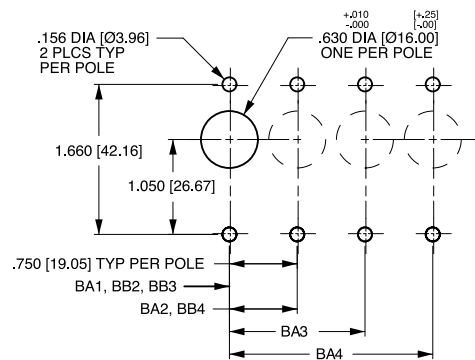
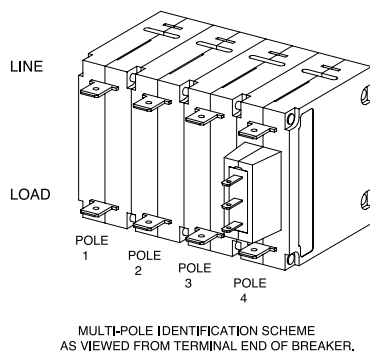
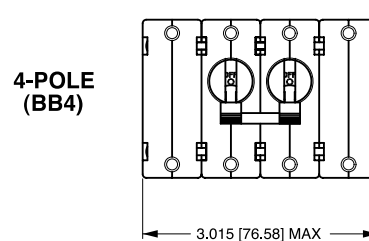
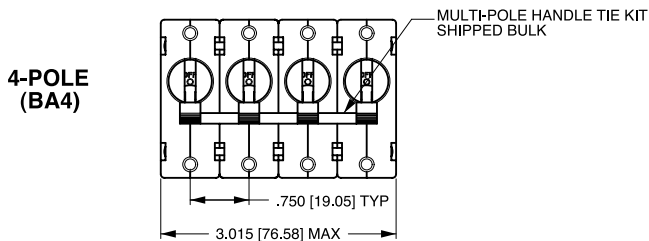
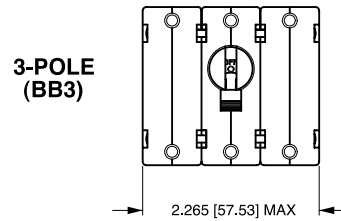
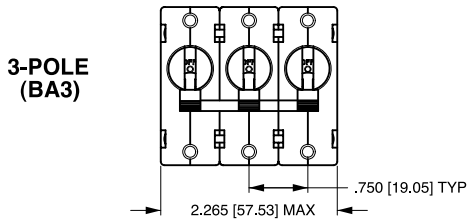
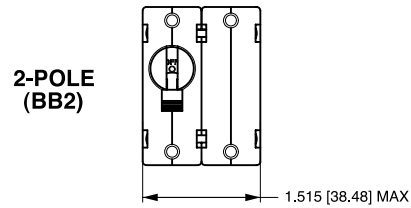
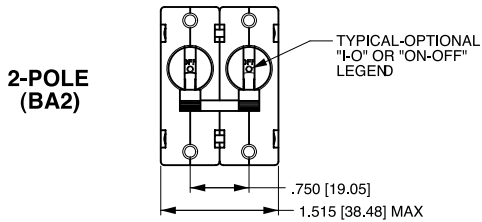

- Notes:
- 1 All dimensions are in inches [millimeters].
  - 2 Tolerance ± 0.20 [±.51] unless otherwise specified.

### Dimensional Specifications: in. [mm]

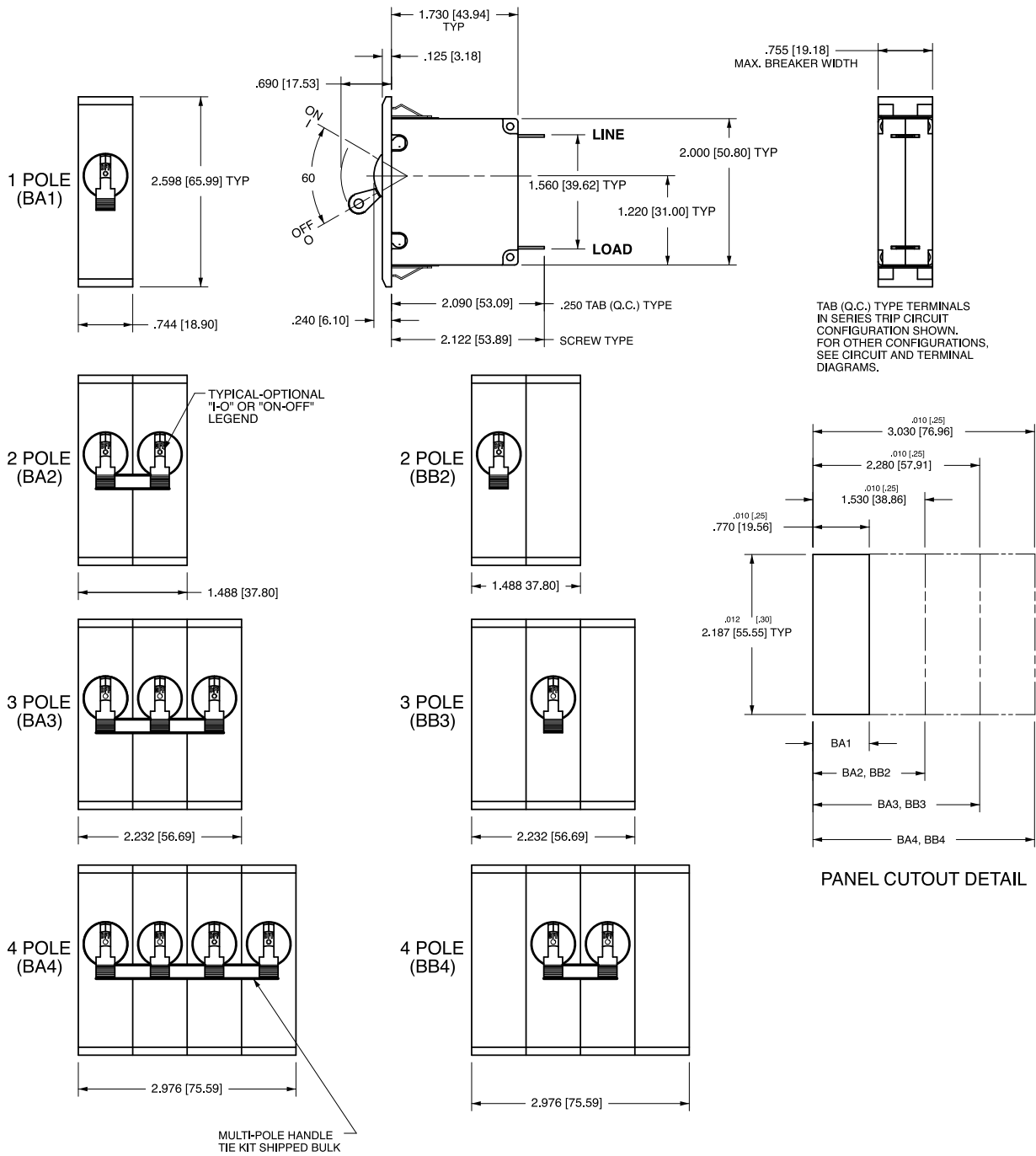

- Notes:  
 1 All dimensions are in inches [millimeters].  
 2 Recommended panel thickness: .040 [1.02] to .100 [2.54].  
 3 Tolerance ±.020 [.51] unless otherwise specified.

## Dimensional Specifications: in. [mm]

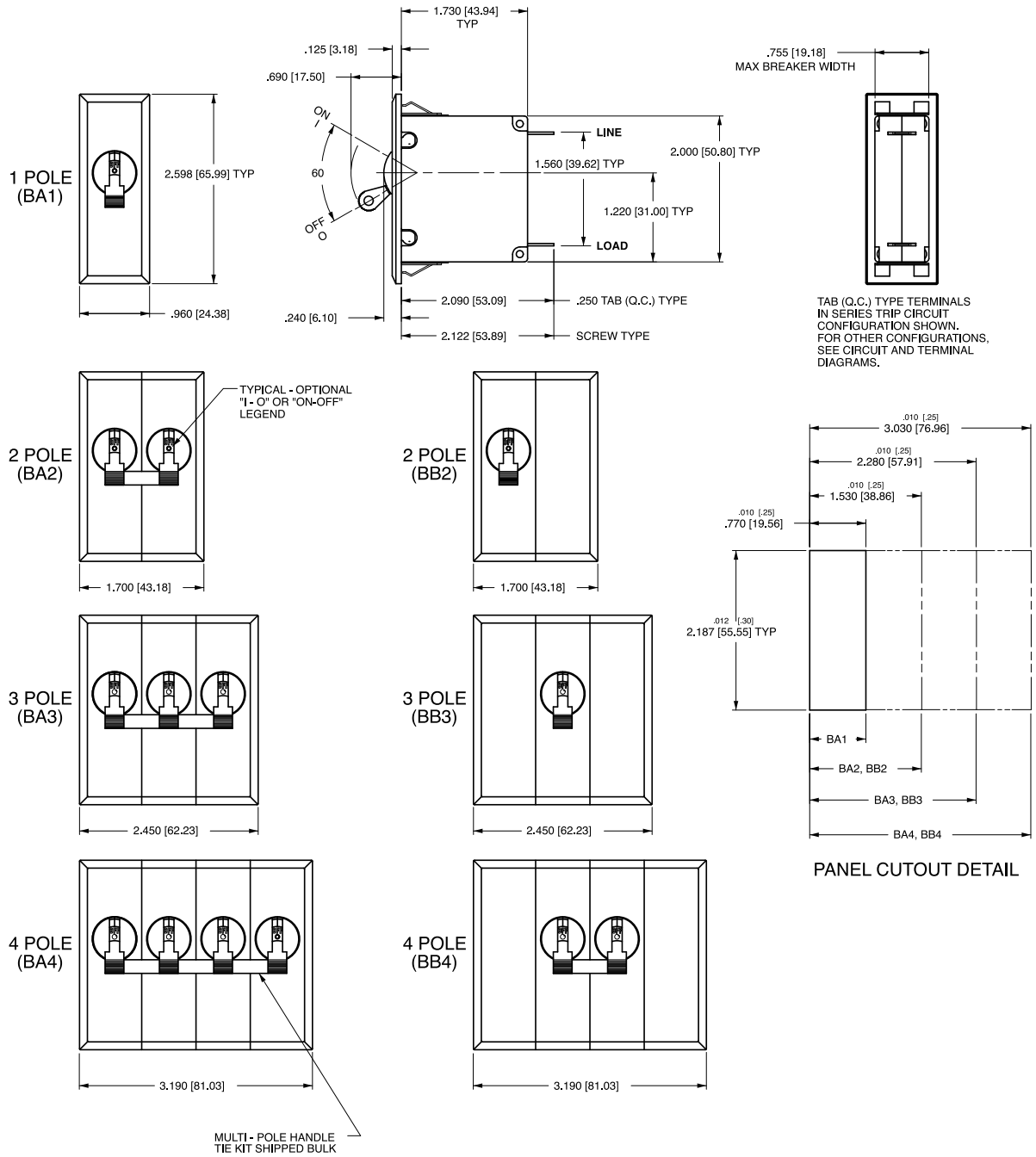

**Notes:**

- 1 All dimensions are in inches [millimeters].
- 2 Recommended panel thickness: .040 [1.02] to .100 [2.54].
- 3 Tolerance  $\pm 0.020$  [.51] unless otherwise specified.

**B** **F** **1** - **B** **0** - **24** - **630** - **2** **3** **A** - **K** **G**

1 Series    2 Actuator    3 Poles    4 Circuit    5 Aux/Alarm Switch    6 Frequency & Delay    7 Current Rating    8 Terminal    9 Actuator Color    10 Mounting/Barriers    11 Max. Appl. Rating    12 Agency Approval

**1 SERIES**

**B**

**2 ACTUATOR**

**Two Color Visi-Rocker**

- C** Indicate ON, vertical legend    **J** Vertical legend  
**D** Indicate ON, horizontal legend    **K** Horizontal legend  
**F** Indicate OFF, vertical legend  
**G** Indicate OFF, horizontal legend

**Single color**

**ROCKER STYLE DESCRIPTIONS**

	INDICATE "ON"	INDICATE "OFF"	SINGLE COLOR
<b>VERTICAL STYLE</b>	<p>CODE "C"</p>	<p>CODE "F"</p>	<p>CODE "J"</p>
<b>HORIZONTAL STYLE</b>	<p>CODE "D"</p>	<p>CODE "G"</p>	<p>CODE "K"</p>

**3 POLES 1,2**

**1** One    **2** Two    **3** Three

**4 CIRCUIT**

**B** Series Trip (Current)

**5 AUXILIARY / ALARM SWITCH 4**

- 0** without Aux Switch    **7** S.P.S.T., 0.110 Q.C. Term.  
**1** S.P.D.T., 0.093 Q.C. Term. (Gold Contacts)  
**2** S.P.D.T., 0.110 Q.C. Term.    **8** S.P.S.T., 0.187 Q.C. Term.  
**3** S.P.D.T., 0.110 Solder Lug    **9** S.P.D.T., 0.187 Q.C. Term.

**6 FREQUENCY & DELAY**

- 21** AC Ultra Short    **42** AC, Short, Hi-Inrush  
**22** AC Short    **44** AC, Medium, Hi-Inrush  
**24** AC Medium    **46** AC, Long, Hi-Inrush  
**26** AC Long

**7 CURRENT RATING (AMPERES)**

CODE	AMPERES	CODE	AMPERES	CODE	AMPERES	CODE	AMPERES
020	0.020	220	0.200	415	1.500	495	9.500
025	0.025	225	0.250	517	1.750	610	10.000
030	0.030	230	0.300	420	2.000	710	10.500
035	0.035	235	0.350	522	2.250	611	11.000
040	0.040	240	0.400	527	2.750	711	11.500
045	0.045	245	0.450	430	3.000	612	12.000
050	0.050	250	0.500	435	3.500	712	12.500
055	0.055	255	0.550	440	4.000	613	13.000
060	0.060	260	0.600	445	4.500	614	14.000
065	0.065	265	0.650	450	5.000	615	15.000
070	0.070	270	0.700	455	5.500	616	16.000
075	0.075	275	0.750	460	6.000	617	17.000
080	0.080	280	0.800	465	6.500	618	18.000
085	0.085	285	0.850	470	7.000	620	20.000
090	0.090	290	0.900	475	7.500	622	22.000
095	0.095	295	0.950	480	8.000	624	24.000
210	0.100	410	1.000	485	8.500	625	25.000
215	0.150	512	1.250	490	9.000	630	30.000

**8 TERMINAL 5**

- 1** <sup>6</sup> Push-On 0.250 Tab (Q.C.)    **B** Screw M5 with upturned lugs  
**2** Screw 8-32 with upturned lugs    **C** Screw M4 with upturned lugs  
**3** Screw 8-32 (Bus Type)    **F** Screw M5 with upturned lugs & 30° bend  
**4** Screw 10-32 with upturned lugs    **G** Screw M5 (Bus Type) & 30° bend  
**5** Screw 10-32 (Bus Type)    **H** Screw M5 (Bus Type)  
**6** Screw 8-32 with upturned lugs & 30° bend    **J** Screw M5 Back Connect  
**7** Screw 8-32 (Bus Type) & 30° bend    **K** Screw 10-32 Back Connect  
**8** Screw 10-32 with upturned lugs & 30° bend    **N** Screw M4 Back Connect  
**9** Screw 10-32 (Bus Type) & 30° bend    **Y** Screw 8-32 Back Connect

**9 ACTUATOR COLOR & LEGEND**

Actuator or Visi-Rocker 7	Marking:		Marking Color	
	ON-OFF	Dual 7	Single Color	Visi-Rocker
White	<b>B</b>	<b>1</b>	Black	White
Black	<b>D</b>	<b>2</b>	White	n/a
Red	<b>G</b>	<b>3</b>	White	Red
Green	<b>J</b>	<b>4</b>	White	Green
Blue	<b>L</b>	<b>5</b>	White	Blue
Yellow	<b>N</b>	<b>6</b>	Black	Yellow
Gray	<b>Q</b>	<b>7</b>	Black	Gray
Orange	<b>S</b>	<b>8</b>	Black	Orange

**10 MOUNTING / BARRIERS**

- MOUNTING STYLE**    **BARRIERS 9**  
**Threaded Insert, 2 per pole**  
**A** 6-32 x 0.195 inches (multi-pole units only)    yes  
**B** ISO M3 x 5mm    yes  
**ROCKERGUARD BEZEL**  
**Threaded Insert, 2 per pole**  
**C** 6-32 X 0.225 inches (multi-pole units only)    yes  
**D** ISO M3 x 6.5mm    yes

**11 MAXIMUM APPLICATION RATING**

- C** <sup>8</sup> 120/240 VAC  
**K** 120 VAC

**12 AGENCY APPROVAL**

- G** UL489 Listed  
**3** UL489 Listed, TUV Certified

Notes:

- Multi-pole breakers have all breakers identical except when specifying Auxiliary switch and/or mixed poles, and have one rocker per breaker.
- All poles must be same polarity.
- 3 pole units available only when 1 of 3 poles is neutral.
- On multi-pole breakers, one auxiliary switch is supplied, mounted in the extreme right pole.
- Screw Terminals are recommended on ratings greater than 20 amps.
- Terminal Code 1 (Push-On) available up to 30 amps, but are not recommended over 20 amps.
- Dual Legend = ON-OFF/I-O
- Voltage Rating available with 2 and 3-pole breakers only.
- Barriers supplied on multi-pole units only.

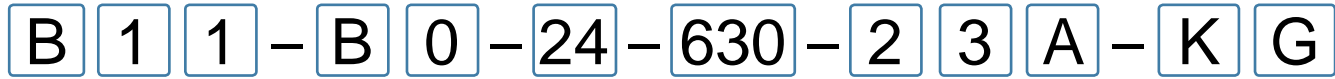

1 Series    2 Actuator    3 Poles    4 Circuit    5 Aux/Alarm Switch    6 Frequency & Delay    7 Current Rating    8 Terminal    9 Actuator Color    10 Mounting/Barriers    11 Max. Appl. Rating    12 Agency Approval

**1 SERIES**  
B

**2 ACTUATOR 1**  
**Two Color Visi-Rocker**  
 1 Indicate OFF, vertical legend  
 2 Indicate OFF, horizontal legend  
**Single color**  
 3 Vertical legend  
 4 Horizontal legend  
**Push-To-Reset, Visi-Rocker**  
 5 Indicate OFF, vertical legend  
 6 Indicate OFF, horizontal legend  
**Push-To-Reset , Single color**  
 7 Vertical legend  
 8 Horizontal legend

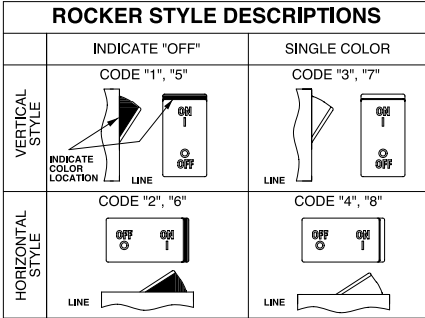

**3 POLES 2,3**  
 1 One                      2 Two                      3<sup>4</sup> Three

**4 CIRCUIT**  
 B Series Trip (Current)

**5 AUXILIARY / ALARM SWITCH 4**  
 0 without Aux Switch                      7 S.P.S.T., 0.110 Q.C. Term.  
 1 S.P.D.T., 0.093 Q.C. Term.                      (Gold Contacts)  
 2 S.P.D.T., 0.110 Q.C. Term.                      8 S.P.S.T., 0.187 Q.C. Term.  
 3 S.P.D.T., 0.110 Solder Lug                      9 S.P.D.T., 0.187 Q.C. Term.

**6 FREQUENCY & DELAY**  
 21 AC Ultra Short                      42 AC, Short, Hi-Inrush  
 22 AC Short                      44 AC, Medium, Hi-Inrush  
 24 AC Medium                      46 AC, Long, Hi-Inrush  
 26 AC Long

**7 CURRENT RATING (AMPERES)**

CODE	AMPERES				
020	0.020	220	0.200	415	1.500
025	0.025	225	0.250	517	1.750
030	0.030	230	0.300	420	2.000
035	0.035	235	0.350	522	2.250
040	0.040	240	0.400	527	2.750
045	0.045	245	0.450	430	3.000
050	0.050	250	0.500	435	3.500
055	0.055	255	0.550	440	4.000
060	0.060	260	0.600	445	4.500
065	0.065	265	0.650	450	5.000
070	0.070	270	0.700	455	5.500
075	0.075	275	0.750	460	6.000
080	0.080	280	0.800	465	6.500
085	0.085	285	0.850	470	7.000
090	0.090	290	0.900	475	7.500
095	0.095	295	0.950	480	8.000
100	0.100	300	1.000	485	8.500
110	0.110	310	1.100	490	9.000
120	0.120	320	1.200		
150	0.150	350	1.500		
200	0.200	400	2.000		
250	0.250	450	2.500		
300	0.300	500	3.000		
400	0.400	600	4.000		
500	0.500	700	5.000		
600	0.600	800	6.000		
700	0.700	900	7.000		
800	0.800	1000	8.000		
900	0.900	1100	9.000		

**8 TERMINAL 6**  
 1<sup>7</sup> Push-On 0.250 Tab (Q.C.)                      B Screw M5 with upturned lugs  
 2 Screw 8-32 with upturned lugs                      C Screw M4 with upturned lugs  
 3 Screw 8-32 (Bus Type)                      F Screw M5 with upturned lugs & 30° bend  
 4 Screw 10-32 with upturned lugs                      G Screw M5 (Bus Type) & 30° bend  
 5 Screw 10-32 (Bus Type)                      H Screw M5 (Bus Type)  
 6 Screw 8-32 with upturned lugs & 30° bend                      J Screw M5 Back Connect  
 7 Screw 8-32 (Bus Type) & 30° bend                      K Screw 10-32 Back Connect  
 8 Screw 10-32 with upturned lugs & 30° bend                      N Screw M4 Back Connect  
 9 Screw 10-32 (Bus Type) & 30° bend                      Y Screw 8-32 Back Connect

**9 ACTUATOR COLOR & LEGEND**

Actuator or Visi-Color <sup>8</sup>	Marking:		Marking Color	
	ON-OFF	Dual <sup>8</sup>	Single Color	Visi-Rocker
White	B	1	Black	White
Black	D	2	White	n/a
Red	G	3	White	Red
Green	J	4	White	Green
Blue	L	5	White	Blue
Yellow	N	6	Black	Yellow
Gray	Q	7	Black	Gray
Orange	S	8	Black	Orange

**10 MOUNTING / BARRIERS 9**  
**STANDARD ROCKER BEZEL**                      BARRIERS<sup>12</sup>  
**Threaded Insert, 2 per pole**  
**FLAT ROCKER ACTUATOR**  
 A 6-32 x 0.195 inches (*multi-pole units only*)                      yes  
 B ISO M3 x 5mm                      yes  
**RECESSED OFF SIDE ROCKER ACTUATOR<sup>10</sup>**  
 E 6-32 X 0.225 inches (*multi-pole units only*)                      yes  
 F ISO M3 x 6.5mm                      yes  
**PUSH-TO-RESET BEZEL, Threaded Insert, 2 per pole**  
 C 6-32 x 0.195 inches                      yes  
 D ISO M3 x 5mm                      yes

**11 MAXIMUM APPLICATION RATING**  
 C<sup>11</sup> 120/240 VAC  
 K 120 VAC

**12 AGENCY APPROVAL**  
 G UL489 Listed  
 3 UL489 Listed, TUV Certified

- Notes:
- 1 Push-To-Reset actuators have OFF portion of rocker shrouded.
  - 2 Multi-pole breakers have all breakers identical except when specifying Auxiliary switch and/or mixed poles, and have one rocker per breaker.
  - 3 All poles must be same polarity.
  - 4 3 pole units available only when 1 of 3 poles is neutral.
  - 5 On multi-pole breakers, one auxiliary switch is supplied, mounted in the extreme right pole.
  - 6 Screw Terminals are recommended on ratings greater than 20 amps.
  - 7 Terminal Code 1 (Push-On) available up to 30 amps, but are not recommended over 20 amps.
  - 8 Color shown is visi and legend with remainder of rocker black. Dual = ON-OFF/I-O legend.
  - 9 Legend on Push-to-reset bezel/shroud is white with single color actuator codes 7 & 8. Legend on Push-To-Reset bezel/shroud matches Visi-Color of rocker with actuator codes 5 & 6.
  - 10 Recessed "off-side" available with actuator codes 1, 2, 3 & 4. Legends on rocker are available in ink stamping only.
  - 11 Voltage rating available with 2 & 3-pole breakers only.
  - 12 Barriers supplied on multi-pole units only.

# Dimensional Specifications: in. [mm]

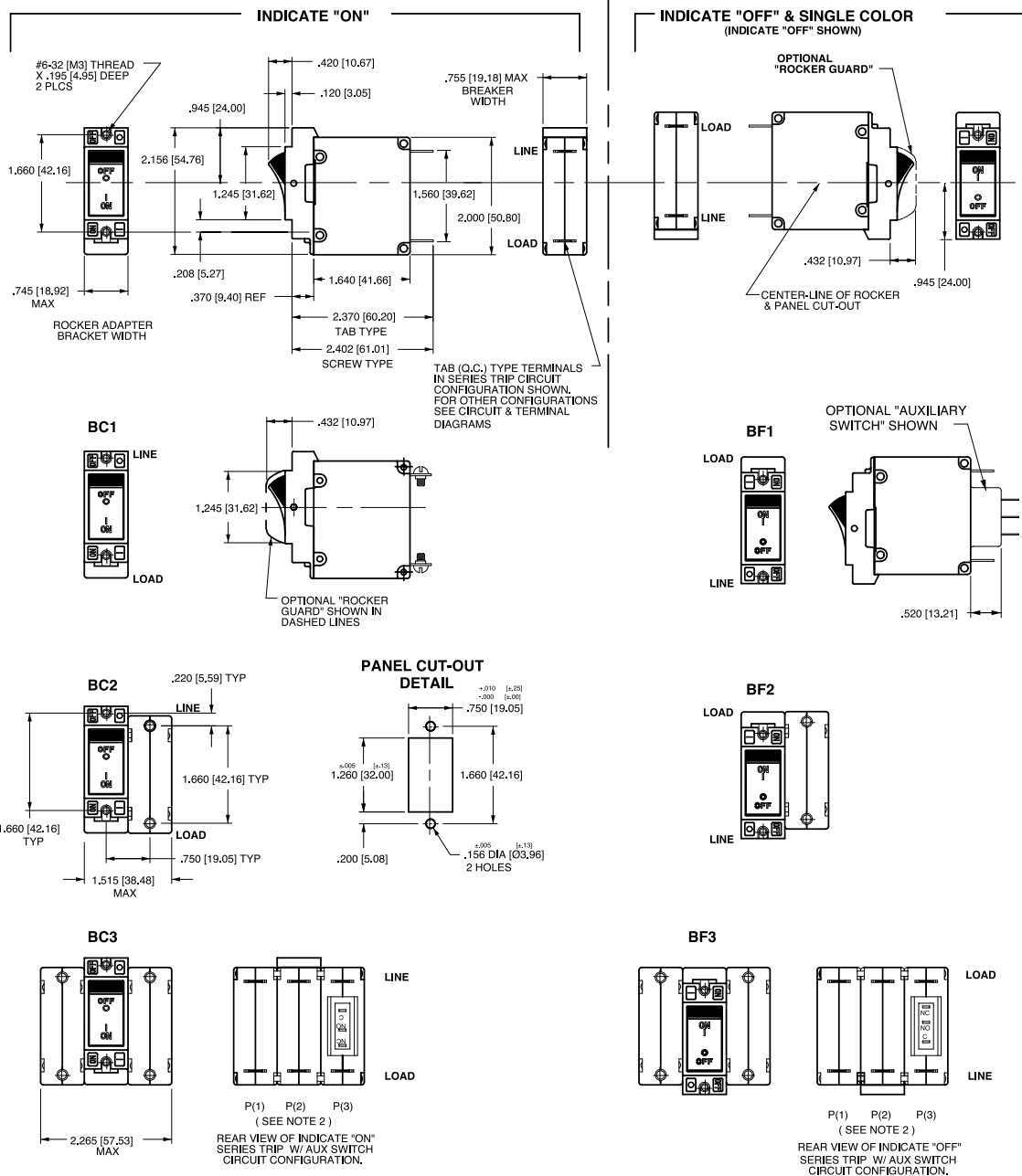

**Notes:**

- 1 Dimensions apply to all variations shown. Notice that circuit breaker line & load terminal orientation on indicate "OFF" is opposite of indicate "ON".
- 2 For pole orientation with horizontal legend, rotate front view clockwise 90°.
- 3 All dimensions are in inches [millimeters].
- 4 Tolerance ±.020 [51] unless otherwise specified.

# Dimensional Specifications: in. [mm]

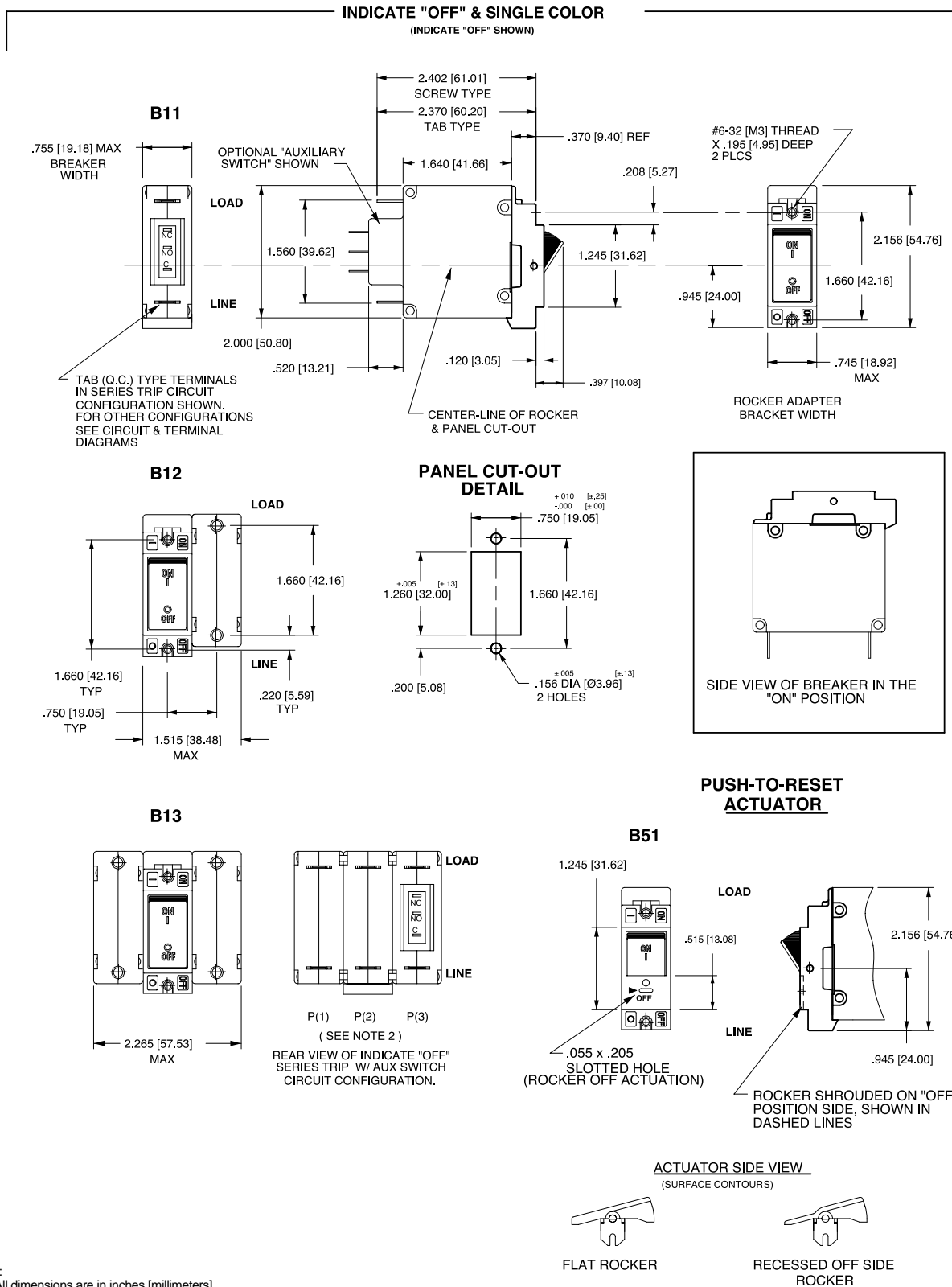

- Notes:
- 1 All dimensions are in inches [millimeters].
  - 2 For pole orientation with horizontal legend, rotate front view clockwise 90°.
  - 3 Tolerance ±.010 [.25] unless otherwise specified.

## PC Terminal Diagrams: in. [mm]

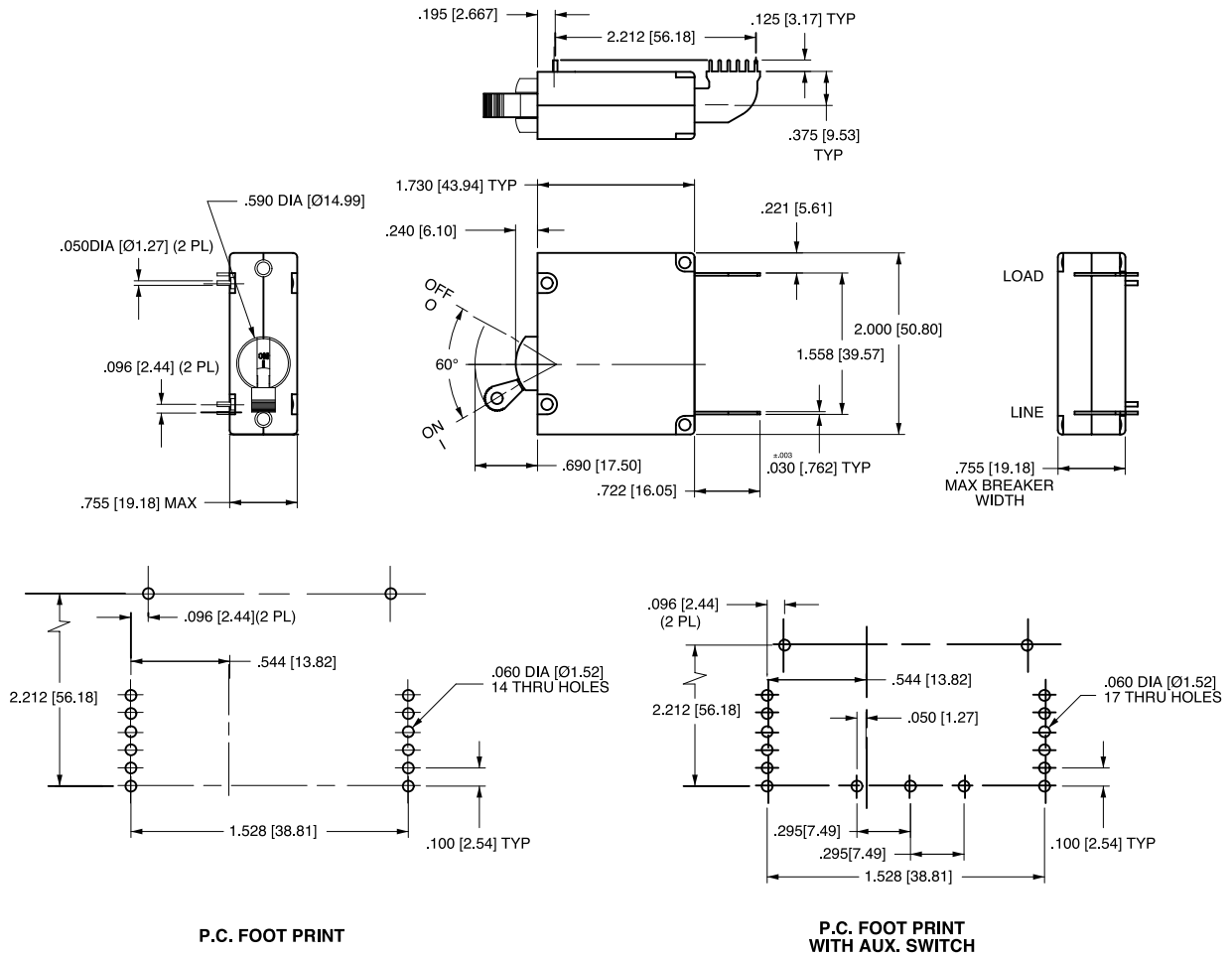

- Notes:
- 1 All dimensions are in inches [millimeters].
  - 2 For pole orientation with horizontal legend, rotate front view clockwise 90°.
  - 3 Tolerance ±.010 [.25] unless otherwise specified.



# C-Series

## CIRCUIT BREAKER

The C-Series hydraulic-magnetic circuit breakers are ideal for applications that require higher amperage and voltage handling capability in a smaller package. They are available in 1-6 poles, 0.02-100amps, UL Recognized up to 480VAC or 150VDC, UL489 Listed up to 240VAC or 125VDC, with choice of time delays, terminal options, actuator styles and colors. The C-Series employs a unique arc chute design which allows for higher interrupting capacities of up to 10,000 amps. New thermoset glass filled polyester half shell construction provides for increased mechanical and electrical strength. The wiping contacts, mechanical linkage with two step actuation, clean contacts providing high, positive contact pressure and longer contact life. Available with American Standard or Metric Threaded Stud terminals, or Saddle Clamp screw terminals. The optional mid-trip handle style actuator allows a visual indication of electrical overload with or without alarm feature.



### Product Highlights:

- Extensive list of Agency Approvals
- Available with Standard or Metric Stud terminals, or Saddle Clamp screw terminals
- Optional mid-trip handle style actuator
- Unique arc chute design which allows for higher interrupting capacities of up to 10,000 amps
- Exclusive Rockerguard and Push-To-Reset bezel
- Available with new solid color and two-color Visi-rocker® actuators
- New thermoset glass filled polyester half shell construction

Only Marine applicable ordering schemes and drawings are shown in this catalog.  
For complete product details, please visit [www.carlingtech.com](http://www.carlingtech.com)

### Electrical

**Maximum Voltage** AC, 480 WYE/277 VAC, 50/60 Hz (see Table A.)  
 UL489: AC, 240 VAC. (See Table D), 50/60 Hz, 125 VDC

**Current Rating** Standard current coils: 0.100, 0.250, 0.500, 0.750, 1.00, 2.50, 5.00, 7.50, 10.0, 15.0, 25.0, 30.0, 35.0, 40.0, 50.0, 60.0, 70.0, 80.0, 90.0 and 100 amps. Other ratings available, see Ordering Scheme.

**Standard Voltage Coils** DC - 6V, 12V; AC - 120V; other ratings available, see Ordering Scheme.

**Auxiliary Switch Rating** SPDT; 10.1 amps-250VAC, DC Aux. Switch 1.0A, 65 VDC. 0.5A, 80VDC, 1/4 HP, 125VAC, VDE & TUV 1.0 125 VAC.

**Insulation Resistance** Minimum of 100 Megohms at 500 VDC.

**Dielectric Strength** UL, CSA: 1960 V 50/60 Hz for one minute between all electrically isolated terminals. C-Series Circuit Breakers comply with the 8mm spacing and 3750V 50/60 Hz dielectric requirements from hazardous voltage to operator accessible surfaces, between adjacent poles and from main circuits to auxiliary circuits per Publications EN 60950 and VDE 0805.

**Resistance, Impedance** Values from Line to Load Terminal - based on Series Trip Circuit Breaker.

RESISTANCE, IMPEDANCE VALUES from Line to Load Terminals (Values Based on Series Trip Circuit Breaker)

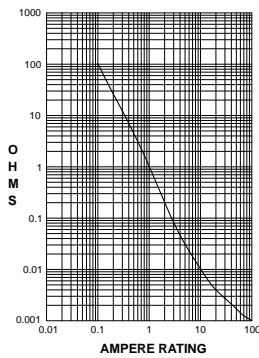

CURRENT (AMPS)	TOLERANCE (%)
0.10 - 5.0	15
5.1 - 20.0	25
20.1 - 50.0	35

### Pulse Tolerance Curves

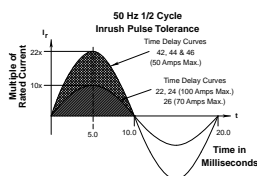
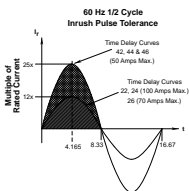

### Mechanical

**Endurance** 10,000 ON-OFF operations @ 6 per minute; with rated current & voltage.

**Trip Free** All C-Series circuit breakers will trip on overload, even when actuator is forcibly held in the ON position.

**Trip Indication** The operating actuator moves positively to the OFF position when an overload causes the breaker to trip. With mid-trip, handle moves to the mid position on electrical trip of the circuit breaker. With mid trip handle with alarm switch, handle moves to the mid position and the alarm switch actuates when the circuit breaker is electrically tripped.

### Physical

**Number of Poles** 1-6 poles ≤ 50A; 1-4 poles @ 51-70A; 1-2 poles 71-100A. UL489 Handle: 1 pole ≤ 100A, 2 pole ≤ 50A; Rocker: 1 pole ≤ 100A.

**Internal Circuit Config.** Series (with or without auxiliary switch, mid trip & mid trip with alarm switch) Shunt & Relay with current or voltage trip coils, Dual Coil, Switch Only (with or without aux. switch). UL489: Series (with or without auxiliary switch, mid-trip & midtrip with alarm switch).

**Weight** Approx. 112 grams/pole ( 3.95 oz).

**Standard Colors** Housing: Black

### Environmental

Designed and tested in accordance with requirements of specification MIL-PRF-55629 & MIL-STD-202 as follows:

**Shock** Withstands 100 Gs, 6ms sawtooth while carrying rated current per Method 213, Test Condition "I". Instantaneous and ultrashort curves tested @ 90% of rated current.

**Vibration** Withstands 0.060" excursion from 10-55 Hz & 10 Gs 55-500 Hz, @ rated current per Method 204C, Test Cond. A. Instantaneous & ultrashort curves tested @ 90% of rated current.

**Moisture Resistance** Method 106D, i.e., ten 24-hour cycles @ +25°C to +65°C, 80-98% RH.

**Salt Spray** Method 101, Condition A (90-95% RH @ 5% NaCl Solution, 96 hrs).

**Thermal Shock** Method 107D, Condition A (five cycles @ -55°C to +25°C to +85°C to +25°C).

**Operating Temperature** -40°C to +85°C

\*Manufacturer reserves the right to change product specification without prior notice.

## Electrical Tables

**Table A:** Lists UL Recognized & CSA Accepted configurations and performance capabilities as a Component Supplementary Protector

C-SERIES TABLE A: COMPONENT SUPPLEMENTARY PROTECTORS										
CIRCUIT CONFIGURATION	VOLTAGE			CURRENT RATING		SHORT CIRCUIT CAPACITY (AMPS)		APPLICATION CODES		NOTES
	MAX. RATING	FREQUENCY	PHASE	FULL LOAD AMPS	GENERAL PURPOSE AMPS	WITH BACKUP FUSE 1	WITHOUT BACKUP FUSE	UL	CSA	
SERIES	32	DC	---	0.02 - 100	---	---	5000	TC1, OL1, U2	TC1, OL1, U2	
	48	DC	---	110 - 150	---	---	5000	TC1, OL1, U2	TC1, OL1, U2	
	65	DC	---	0.02 - 70	---	---	5000	TC1,2, OL1,U1	TC1,2, OL1,U1	
				---	71 - 100	---	5000	TC1,2, OL0,U1	TC1,2, OL0,U1	
	80	DC	---	0.02 - 70	---	---	7500	TC1,2, OL1,U1	TC1,2, OL1,U1	
				---	71 - 100	---	7500	TC1,2, OL0,U1	TC1,2, OL0,U1	
	80	DC	---	0.02 - 70	---	---	10,000	TC1,2, OL1,U1	TC1,2, OL1,U1	Must Have Agency Code "L"
				---	71 - 100	---	10,000	TC1,2, OL0,U1	TC1,2, OL0,U1	Must Have Agency Code "L"
	125	DC	---	0.02 - 50	---	---	5000	TC1,2,OL1,U1	TC1,2,OL1,U1	Must Have Agency Code "L"
	125 / 250	DC	---	0.02 - 50	---	---	5000	TC1,2,OL1,U1	TC1,2,OL1,U1	Must Have Agency Code "L"
	250	DC	---	0.02 - 50	---	---	5000	TC1,2,OL1,U1	TC1,2,OL1,U1	Must Have Agency Code "L". 2 Pole Break Required for 250 Volts
	125	50 / 60	1	0.02 - 100	---	---	3000	TC1, OL1, U2	TC1, OL1, U2	Per Pole Rating
				0.02 - 100	---	---	5000	TC1,2,OL1,U1	TC1,2,OL1,U1	Must Have Agency Code "L"
	150	DC	---	---	80 - 100	---	5000	TC1, OL0, U3	---	Must Have Agency Code "L"
	150	DC	---	---	101 - 175	---	5000	TC1, OL0, U3	---	Must Have Agency Code "L" Parallel Pole
	125 / 250	50 / 60	1	0.02 - 100	---	---	3500	TC1, OL1, U2	TC1, OL1, U2	
				0.02 - 50	---	---	3000	TC1,2,OL1,U1	TC1,2,OL1,U1	2 or 3 poles breaking single phase
				51 - 100	---	---	1000	TC1,2,OL1,U1	TC1,2,OL1,U1	2 or 3 poles breaking single phase
				0.02 - 100	---	---	5000	TC1,2,OL1,U2	TC1,2,OL1,U2	2 or 3 poles breaking single phase, "L" Agency Code
				0.02 - 50	---	---	3500	TC1, OL1, U2	TC1, OL1, U2	Per Pole Rating
				0.02 - 100	---	---	5000	TC1,2,OL1,U1	TC1,2,OL1,U1	Must Have Agency Code "L"
	250	50 / 60	1	51 - 70	---	5000	---	TC1,2,OL1,C1	TC1,2,OL1,C1	
				---	0.02 - 100	---	3000	TC1, OL0, U2	TC1, OL0, U2	
			3	0.02 - 70	---	5000	---	TC1,2,OL1,C1	TC1,2,OL1,C1	3 poles breaking 3 phase
			---	0.02 - 90	---	5000	TC1,2,OL0,U1	TC1,2,OL0,U1	Must Have Agency Code "L"	
277	50 / 60	1	0.02 - 50	---	5000	---	TC1,2,OL1,C1	TC1,2,OL1,C1		
480 / 277	50 / 60	3	0.02 - 30	---	5000	---	TC1,2,OL1,C1	TC1,2,OL1,C1	3 poles breaking 3 phase	
			---	31 - 50	5000	---	TC1,2,OL0,C1	TC1,2,OL0,C1		
480	50 / 60	1	0.02 - 30	---	5000	---	TC1,2,OL1,C1	TC1,2,OL1,C1	2 poles breaking 1 phase	
			---	31 - 50	5000	---	TC1,2,OL0,C1	TC1,2,OL0,C1		
DUAL COIL	80	DC	---	0.02 - 50	---	---	7500	TC1,2, OL1,U1	TC1,2, OL1,U1	
	125	50 / 60	1	0.02 - 50	---	---	3000	TC1, OL1, U2	TC1, OL1, U2	Per Pole Rating
	125 / 250	50 / 60	1	0.02 - 50	---	---	3500	TC1, OL1, U2	TC1, OL1, U2	2 or 3 poles breaking single phase
				0.02 - 50	---	---	3000	TC1,2,OL1,U1	TC1,2,OL1,U1	2 or 3 poles breaking single phase
	250	50 / 60	3	0.02 - 50	---	---	3500	TC1, OL1, U2	TC1, OL1, U2	
			0.02 - 50	---	---	3000	TC1, OL0, U2	TC1, OL0, U2	Per Pole Rating	
			0.02 - 50	---	5000	---	TC1,2,OL1,C1	TC1,2,OL1,C1		
277	50 / 60	1	0.02 - 50	---	5000	---	TC1,2,OL1,C1	TC1,2,OL1,C1	3 poles breaking 3 phase	
SHUNT	80	DC	---	0.02 - 50	---	---	7500	TC1,2, OL1,U1	TC1,2, OL1,U1	
	277	50 / 60	1	0.02 - 50	---	5000	---	TC1,2,OL1,C1	TC1,2,OL1,C1	
	250	50 / 60	3	0.02 - 50	---	5000	---	TC1,2,OL1,C1	TC1,2,OL1,C1	3 poles breaking 3 phase
				0.02 - 30	---	5000	---	TC1,2,OL1,C1	TC1,2,OL1,C1	3 poles breaking 3 phase
	480 / 277	50 / 60	3	---	31 - 50	5000	---	TC1,2,OL0,C1	TC1,2,OL0,C1	
			0.02 - 30	---	5000	---	TC1,2,OL1,C1	TC1,2,OL1,C1	2 poles breaking 1 phase	
			---	31 - 50	5000	---	TC1,2,OL0,C1	TC1,2,OL0,C1		
RELAY	80	DC	---	0.02 - 50	---	---	7500	TC1,2, OL1,U1	TC1,2, OL1,U1	
	277	50 / 60	1	0.02 - 50	---	5000	---	TC1,2,OL1,C1	TC1,2,OL1,C1	
	250	50 / 60	3	0.02 - 50	---	5000	---	TC1,2,OL1,C1	TC1,2,OL1,C1	3 poles breaking 3 phase
SWITCH ONLY	65	DC	---	0.02 - 70	---	---	---	---	---	
				---	71 - 100	---	---	---	---	
	80	DC	---	0.02 - 70	---	---	---	---	---	
				---	71 - 100	---	---	---	---	
	125	50 / 60	1	0.02 - 100	---	---	---	---	---	
	125 / 250	50 / 60	1	0.02 - 100	---	---	---	---	---	2 or 3 poles breaking single phase
	250	50 / 60	3	0.02 - 70	---	---	---	---	---	
277	50 / 60	1	0.02 - 50	---	---	---	---	---		
			0.02 - 30	---	---	---	---	---	3 poles breaking 3 phase	
			---	31 - 50	---	---	---	---		

**Notes:**

- Requires branch circuit backup with a UL LISTED Type K5 or RK5 fuse rated 15A minimum and no more than 4 times full load amps not to exceed 125A for 50 Amp or less rating and not to exceed 175 for 51 through 100 Amp rating

## Electrical Tables

**Table B:** Lists UL Recognized and CSA Accepted configurations and performance capabilities as a Manual Motor Controller.

C-SERIES TABLE B: MANUAL MOTOR CONTROLLERS					
CIRCUIT CONFIGURATION	VOLTAGE			CURRENT RATING	HORSEPOWER RATINGS
	MAX. RATING	FREQUENCY	PHASE	FULL LOAD AMPS	MAX HP
SERIES, SHUNT & RELAY SWITCH ONLY	120 <sup>1</sup>	50 / 60	1	0.02 - 50	7 1/2
	250 <sup>1</sup>	50 / 60	1	0.02 - 20	3
			3	0.02 - 20	5
	277 <sup>1</sup>	50 / 60	1	0.02 - 20	3
480 <sup>2</sup>	50 / 60	3	0.02 - 20	5	

Notes:

1 UL recognized and CSA Accepted at 480V refers to 3 & 4 pole versions used in a 3Ø, wye connected circuit or 2-pole version connected with 2 poles breaking. 1Ø and backed up with series fusing as stated above in note 1.

\* Series, Shunt and Relay Trip - Voltage Coil Construction not current coils

**Table C:** Lists UL Recognized, CSA Accepted, VDE and TUV Certified configurations and performance capabilities as a Component Supplementary Protector.

C-SERIES TABLE C: COMPONENT SUPPLEMENTARY PROTECTORS														
CIRCUIT CONFIGURATION	VOLTAGE			CURRENT RATING		SHORT CIRCUIT CAPACITY (AMPS)						APPLICATION CODES		CONSTRUCTION NOTES
	MAX. RATING	FREQUENCY	PHASE	FULL LOAD AMPS	GENERAL PURPOSE AMPS <sup>1</sup>	UL/CSA		VDE		TUV		UL	CSA	
						WITH BACKUP FUSE	WITHOUT BACKUP FUSE	(Inc) WITH BACKUP FUSE	(In) WITHOUT BACKUP FUSE	(Inc) WITH BACKUP FUSE	(In) WITHOUT BACKUP FUSE			
SERIES	80	DC	---	0.10 - 70	---	---	7500	---	5000	5000	1500	TC1.2, OL1,U1	TC1.2, OL1,U1	
			---	71 - 100	71 - 100	---	10,000	---	5000	---	5000	TC1.2, OL0,U1	TC1.2, OL0,U1	Agency Code F, H, J or R Only
	125	DC	---	1 - 50	---	---	5000	---	---	---	5000	TC1.2, OL1,U1	TC1.2, OL1,U1	Agency Code J or R Only
			---	0.10 - 50	---	---	5000	---	---	---	5000	TC1.2, OL1,U1	TC1.2, OL1,U1	Agency Code J or R Only, 2P
	250	50 / 60	1	0.10 - 70	---	---	5000	3000	1500	3000	1500	TC1.2, OL1,U1	TC1.2, OL1,U1	
				0.10 - 100	---	---	5000	---	---	5000	5000	TC1.2, OL1,U1	TC1.2, OL1,U1	Agency Code J or R Only
			3	0.10 - 90	---	---	5000	---	---	5000	5000	TC1.2, OL1,U1	TC1.2, OL1,U1	Agency Code J or R Only
	415	50 / 60	3	0.10 - 30	---	---	5000	---	3000	1500	3000	1500	TC1.2, OL1,C1	TC1.2, OL1,C1
---						5000	---	5000	2500	3000	1500	TC1.2, OL1,C1	TC1.2, OL1,C1	Handle/ Agency F, H, J, or R
DUAL COIL	80	DC	---	0.10 - 30	---	---	7500	---	1500	5000	1500	TC1.2, OL1,U1	TC1.2, OL1,U1	
	250	50 / 60	1 & 3	0.10 - 30	---	---	5000	3000	1500	3000	1500	TC1.2, OL1,U1	TC1.2, OL1,U1	
SHUNT	80	DC	---	0.10 - 70	---	---	7500	---	5000	5000	1500	TC1.2, OL1,U1	TC1.2, OL1,U1	
	250	50 / 60	1 & 3	0.10 - 70	---	---	5000	3000	1500	3000	1500	TC1.2, OL1,U1	TC1.2, OL1,U1	
	415	50 / 60	3	0.10 - 30	---	---	5000	---	3000	1500	3000	1500	TC1.2, OL1,C1	TC1.2, OL1,C1
						5000	---	5000	2500	3000	1500	TC1.2, OL1,C1	TC1.2, OL1,C1	Handle/ Agency F, H, J, or R

Notes:

1. General Purpose ratings for UL/CSA only.

2. Requires branch circuit backup with a UL LISTED Type K5 or RK5 fuse rated 15A minimum and no more than 4 times full load amps not to exceed 125A for 50 Amp or less rating and not to exceed 175 for 51 through 100 Amp rating.

**Table D:** Lists UL Listed (489), CSA Certified (C22.2 No. 5.1-M) configuration and performance capabilities as a Molded Case Circuit Breaker.

C SERIES TABLE D : UL489 LISTED BRANCH CIRCUIT BREAKERS						
CIRCUIT CONFIGURATION	VOLTAGE			CURRENT RATING	INTERRUPTING CAPACITY (AMPS)	CONSTRUCTION NOTES
	MAX. RATING	FREQUENCY	PHASE	FULL LOAD AMPS	WITHOUT BACKUP FUSE	
SERIES	80	DC	---	0.10 - 100	50,000 <sup>1</sup>	Limited to 2 Poles Max from 71 - 100 Amps.
					10,000	Limited to 2 Poles Max from 71 - 100 Amps.
	125	DC	---	0.10 - 100	5,000	1 - 3 Poles
					5,000	1 or 2 Poles (2 Poles Required for 250 Volts)
	120	50 / 60	1	0.10 - 50	10,000	1 - 3 Poles
					5,000	1 - 3 Poles
	120 / 240	50 / 60	1	0.10 - 50	5,000	2 or 3 Poles. 1 Pole of a 3 Pole Unit is Neutral
					10000 <sup>1</sup>	2 or 3 Poles. 1 Pole of a 3 Pole Unit is Neutral
	240	50 / 60	1	0.10 - 30	5,000	1 Pole
	240	50 / 60	1	0.10 - 20	5,000	2 Pole
277	50 / 60	1	0.10 - 20	10,000	1 Pole	
DUAL COIL	120	50 / 60	1	0.10 - 30	10,000	---

Notes from Table D:

1. Special catalog number required. Consult factory.

## Electrical Tables

**Table E:** Lists UL Recognized, CSA Accepted configurations and performance capabilities as Protectors, Supplementary for Marine Electrical and Fuel Systems (Guide PEQZ2, File E75596). Ignition Protected per UL 1500. UL Classified Small Craft Electrical Devices, Marine in accordance with ISO 8846 (Guide UZMK, File MQ1515) as Marine Supplementary Protectors.

C-SERIES TABLE E: UL1500 (Marine Ignition Protected)								
CIRCUIT CONFIGURATION	VOLTAGE			CURRENT RATING	INTERRUPTING CAPACITY (AMPS)	APPLICATION CODES		CONSTRUCTION NOTES
	MAX. RATING	FREQUENCY	PHASE			UL	CSA	
SERIES	48	DC	---	0.02 - 100	5000	TC1,2,OL1,U1	TC1,2,OL1,U1	—
				101 - 150	5000	TC1,2,OL1,U1	TC1,2,OL1,U1	—
	65	DC	---	0.02 - 100	1500	TC1,2,OL0,U1	TC1,2,OL0,U1	—
				80	DC	---	0.02 - 70	1500
	125	50 / 60	1	0.02 - 70	5000	TC1,2,OL1,U1	TC1,2,OL1,U1	—
				71 - 100	1500	TC1,2,OL1,U1	TC1,2,OL1,U1	—
	250	50 / 60	1	0.02 - 70	1500	TC1,2,OL1,U1	TC1,2,OL1,U1	—
				71 - 100	1500	TC1,2,OL1,U1	TC1,2,OL1,U1	2 Poles Breaking Single Phase

**Table F:** Lists UL Listed configurations and performance capabilities as Circuit Breakers for use in Communications Equipment (Guide DITT, File E189195), under UL489A.

C-SERIES TABLE F : PARALLEL POLE CONSTRUCTION UL489A LISTED FOR COMMUNICATIONS EQUIPMENT				
CIRCUIT CONFIGURATION	VOLTAGE		CURRENT RATING	INTERRUPTING CAPACITY (AMPS)
	MAX. RATING	FREQUENCY		
SERIES	80	DC	110 - 250	10,000

## Agency Certifications

**UL Recognized**  
UL Standard 1077  

Component Recognition Program as Protectors Supplementary (Guide CCN/QVNU2, File E75596)

**CSA Accepted**  



Component Supplementary Protector under Class 3215 30, File 047848 0 000 CSA Standard C22.2 No. 235

UL Standard 508  

Switches, Industrial Control (Guide CCN/NRNT2, File E148683)

**CSA Certified**  



Circuit Breaker Model Case (Class 1432 01, File 093910), CSA Standard C22.2 No. 5.1 - M

UL Standard 1500  

Protectors, Supplementary for Marine Electrical & Fuel Systems (Guide PEQZ2, File E75596) Ignition Protection

**TUV Certified**  



EN60934, under License No. R72040875

**UL Listed**  
UL Standard 489  

Circuit Breakers, Molded Case, (Guide DIVQ, File E129899)

**VDE Certified**  

EN60934, VDE 0642 under File No. 10537

UL Standard 489A  

Communications Equipment (Guide CCN/DITT, File E189195)

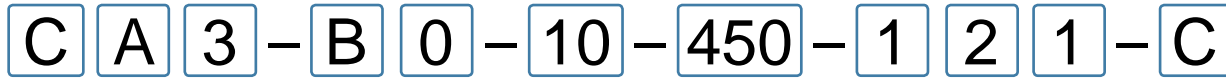

1 Series    2 Actuator    3 Poles    4 Circuit    5 Aux/Alarm Switch    6 Frequency & Delay    7 Current Rating    8 Terminal    9 Actuator Color    10 Mounting Bezel/Barrier    11 Agency Approval

**1 SERIES**  
**C**

**2 ACTUATOR 1**  
**A** Handle, one per pole  
**B** Handle, one per multipole unit  
**S** Mid-Trip Handle, one per pole  
**T** Mid-Trip Handle, one per pole & Alarm Switch

**3 POLES 2**  
**1** One    **3** Three    **5** Five  
**2** Two    **4** Four    **6** Six

**4 CIRCUIT 3**  
**A**<sup>3</sup> Switch Only (No Coil)    **F**<sup>4</sup> Relay Trip (Current)  
**B** Series Trip (Current)    **G**<sup>4</sup> Relay Trip (Voltage)  
**C** Series Trip (Voltage)    **H**<sup>4,5</sup> Dual Coil with Shunt Trip Voltage Coil  
**D**<sup>4</sup> Shunt Trip (Current)    **K**<sup>4,5</sup> Dual Coil with Relay Trip Voltage Coil  
**E**<sup>4</sup> Shunt Trip (Voltage)

**5 AUXILIARY / ALARM SWITCH**  
**0** without Aux Switch    **6** S.P.D.T., 0.139 Solder Lug  
**2** S.P.D.T., 0.110 Q.C. Term.    **8** S.P.S.T., 0.187 Q.C. Term.  
**3** S.P.D.T., 0.139 Solder Lug    **9** S.P.D.T., 0.187 Q.C. Term.  
**4** S.P.D.T., 0.110 Q.C. Term. (Gold Contacts)

**6 FREQUENCY & DELAY**  
**03**<sup>3</sup> DC 50/60Hz, Switch Only    **30** DC 50/60Hz Instantaneous  
**10**<sup>7</sup> DC Instantaneous    **31** DC 50/60Hz Ultra Short  
**11** DC Ultra Short    **32** DC 50/60Hz Short  
**12** DC Short    **34** DC 50/60Hz Medium  
**14** DC Medium    **36** DC 50/60Hz Long  
**16** DC Long    **42**<sup>8</sup> 50/60Hz Short, Hi-Inrush  
**20**<sup>7</sup> 50/60Hz Instantaneous    **44**<sup>8</sup> 50/60Hz Medium, Hi-Inrush  
**21** 50/60Hz Ultra Short    **46**<sup>8</sup> 50/60Hz Long, Hi-Inrush  
**22** 50/60Hz Short    **52**<sup>8</sup> DC Short, Hi-Inrush  
**24** 50/60Hz Medium    **54**<sup>8</sup> DC Medium, Hi-Inrush  
**26** 50/60Hz Long    **56** DC Long, Hi-Inrush

- Notes:  
1 Actuator Code:  
A: Handle tie pin spacer(s) and retainers provided assembled with multi-pole units.  
B: Handle location as viewed from front of breaker.  
2 pole - left pole    3 pole - center pole    4 pole - two handles at center poles  
5 pole - three handles at center poles    6 pole - four handles at center poles  
S: Handle moves to mid-position only upon electrical trip of the breaker. Available with circuit codes B, C, D, E, F, G, H and K.  
T: Handle moves to mid-position and alarm switch activates only upon electrical trip of the breaker. Available with circuit codes B & C.  
2 Standard multipole units have all poles identical except when specifying auxiliary switch and/or mixed poles. 4 pole max with VDE. 5th pole available as Series Trip with Voltage Coil only.  
3 Switch Only circuits, rated up to 50 amps and 6 poles, and only available with VDE Certification when tied to a protected pole (Circuit Code B, C, D or H.). For .02 to 30 amps, select Current Code 630. For 35 - 50 amps, select Current Code 650. For 55-70 amps, select Current Code 670. For 75-100 amps, select Current Code 810.  
4 Circuit Codes D,E,F,G,H & K available with Terminal Codes 1,2,4 & 5 only. Circuit Codes D, F, H & K available up to 50 amps maximum Current Rating.  
5 Consult factory for available Dual Coil options, as special catalog number is required. Dual Coil Voltage Coils with Shunt Trip Construction trip instantaneously on line voltage. Dual Coil Voltage Coils require 30VA minimum power to trip instantaneously and are rated for intermittent duty only.  
6 Auxiliary Switch available with Series Trip and Switch Only circuits. On multi-pole breakers, one auxiliary switch is supplied, mounted in the extreme right pole.  
7 Voltage coils not rated for continuous duty. Available only with delay codes 10 & 20.  
8 Available with Circuit Codes B & D only, and up to 50 amps maximum.  
9 Current Ratings 60 - 70 are available up to four poles maximum. Ratings 71 - 100 are available up to two poles maximum.  
10 Terminal Code 1 available to 60 amps maximum.  
11 Terminal Codes 2, 4, 5 and C available to 50 amps maximum.  
12 Terminal Codes 3, 6 & 9 available to 100 amps maximum.  
13 Terminal Code 7 available to 25 amps maximum.  
14 Terminal Code A available to 100 amps maximum.  
15 Terminal Codes 7, 9 & C are not VDE approved.  
16 No marking available. Consult factory. VDE/TUV Approval requires dual (I-O, ON-OFF) or I-O markings on all handles.  
17 Single pole only.  
18 VDE/TUV: 30 amps max.; UL/CSA: 50 amps max.; Available in 2 - 4 poles only and limited to AC Delays. "General Purpose amps" not rated for "full load amps" or to be used in applications with a motor.

**7 CURRENT RATING (AMPERES)**

CODE	AMPERES	235	0.350	430	3.000	614	14.000
020	0.020	235	0.350	430	3.000	614	14.000
025	0.025	240	0.400	435	3.500	615	15.000
030	0.030	245	0.450	440	4.000	616	16.000
035	0.035	250	0.500	445	4.500	617	17.000
040	0.040	255	0.550	450	5.000	618	18.000
045	0.045	260	0.600	455	5.500	620	20.000
050	0.050	265	0.650	460	6.000	622	22.000
055	0.055	270	0.700	465	6.500	624	24.000
060	0.060	275	0.750	470	7.000	625	25.000
065	0.065	280	0.800	475	7.500	630	30.000
070	0.070	285	0.850	480	8.000	635	35.000
075	0.075	290	0.900	485	8.500	640	40.000
080	0.080	295	0.950	490	9.000	650	50.000
085	0.085	410	1.000	495	9.500	660	60.000
090	0.090	512	1.250	610	10.000	670	70.000
095	0.095	415	1.500	710	10.500	680	80.000
210	0.100	517	1.750	611	11.000	685	85.000
215	0.150	420	2.000	711	11.500	690	90.000
220	0.200	522	2.250	612	12.000	695	95.000
225	0.250	425	2.500	712	12.500	810	100.000
230	0.300	527	2.750	613	13.000		

**OR VOLTAGE COIL (NORMAL RATED VOLTAGE) 7**

CODE	AMPERES	A32	32 DC	J12	12 AC	J65	65 AC
A06	6 DC	A32	32 DC	J12	12 AC	J65	65 AC
A12	12 DC	A48	48 DC	J18	18 AC	K20	120 AC
A18	18 DC	A65	65 DC	J24	24 AC	L40	240 AC
A24	24 DC	J06	6 AC	J48	48 AC		

**8 TERMINAL 15**

1	<sup>10</sup> Stud 10-32	6	<sup>12</sup> Stud M6
2	<sup>11</sup> Screw 10-32	7	<sup>13,15</sup> 0.250 Double Click Connect
3	<sup>12</sup> Stud 1/4-20	9	<sup>15</sup> 7/16" Clip Terminal
4	<sup>11</sup> Stud M5 x 0.8	A	<sup>14</sup> Plug-In Stud
5	<sup>11</sup> Screw M5 x 0.8	C	<sup>11,15</sup> 5/16" Clip Terminal

**9 ACTUATOR COLOR & LEGEND 16**

Actuator Color	I-O	ON-OFF	Dual	Legend Color
White	A	B	1	Black
Black	C	D	2	White
Red	F	G	3	White
Green	H	J	4	White
Blue	K	L	5	White
Yellow	M	N	6	Black
Gray	P	Q	7	Black
Orange	R	S	8	Black
Black (short handle) <sup>17</sup>	T	U	9	White

**10 MOUNTING / BARRIERS**

MOUNTING STYLE	BARRIERS	VOLTAGE
<b>Threaded Insert</b>		
1	6-32 x 0.195 inches	no < 300
A	6-32 X 0.195 inches	yes < 300
C 18	6-32 X 0.195 inches	yes ≥ 300
2	ISO M3 x 5mm	no < 300
B	ISO M3 x 5mm	yes < 300
D 18	ISO M3 x 5mm	yes ≥ 300
<b>Front panel Snap-In, 1.00" [25.4mm] wide bezel</b>		
E <sup>17</sup>	with Handleguard	no < 300

**11 AGENCY APPROVAL**

- C** UL Recognized, CSA Accepted
- D** VDE Certified, UL Recognized, CSA Accepted
- E** TUV Certified, UL Recognized, CSA Accepted
- H** UL489 Construction: VDE Certified, UL Recognized, CSA Accepted
- I** UL Recognized STD 1077, UL Recognized 1500 (ignition protected), CSA Accepted
- L** UL489 Construction: UL Recognized, CSA Accepted
- R** UL489 Construction: TUV Certified, UL Recognized, CSA Accepted

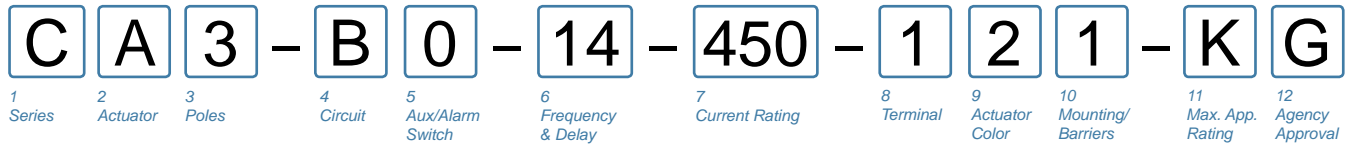

**1 SERIES**  
**C**

**2 ACTUATOR 1**  
**A** Handle, one per pole  
**B** Handle, one per multipole unit  
**S** Mid-Trip Handle, one per pole  
**T** Mid-Trip Handle, one per pole & Alarm Switch

**3 POLES 2**  
**1** One                      **2** Two                      **3** Three

**4 CIRCUIT**  
**B** Series Trip (Current)

**5 AUXILIARY / ALARM SWITCH 3**  
**0** without Aux Switch  
**2** S.P.D.T., 0.110 Q.C. Term.      **6** S.P.S.T., 0.139 Solder Lug  
**3** S.P.D.T., 0.139 Solder Lug      **8** S.P.S.T., 0.187 Q.C. Term.  
**4** S.P.D.T., 0.110 Q.C. Term. (Gold Contacts)      **9** S.P.D.T., 0.187 Q.C. Term.

**6 FREQUENCY & DELAY**  
**11** DC Ultra Short                      **26** 50/60Hz Long  
**12** DC Short                              **42** 4 50/60Hz Short, Hi-Inrush  
**14** DC Medium                          **44** 4 50/60Hz Medium, Hi-Inrush  
**16** DC Long                                **46** 4 50/60Hz Long, Hi-Inrush  
**21** 50/60Hz Ultra Short              **52** 4 DC Short, Hi-Inrush  
**22** 50/60Hz Short                        **54** 4 DC Medium, Hi-Inrush  
**24** 50/60Hz Medium                    **56** 4 DC Long, Hi-Inrush

**7 CURRENT RATING (AMPERES)**

CODE	AMPERES	295	0.950	470	7.000	618	18.000
210	0.100	295	0.950	470	7.000	618	18.000
215	0.150	410	1.000	475	7.500	620	20.000
220	0.200	512	1.250	480	8.000	622	22.000
225	0.250	415	1.500	485	8.500	624	24.000
230	0.300	517	1.750	490	9.000	625	25.000
235	0.350	420	2.000	495	9.500	630	30.000
240	0.400	522	2.250	610	10.000	635	35.000
245	0.450	425	2.500	710	10.500	640	40.000
250	0.500	527	2.750	611	11.000	660	60.000
255	0.550	430	3.000	711	11.500	670	70.000
260	0.600	435	3.500	612	12.000	680	80.000
265	0.650	440	4.000	712	12.500	685	85.000
270	0.700	445	4.500	613	13.000	690	90.000
275	0.750	450	5.000	614	14.000	695	95.000
280	0.800	455	5.500	615	15.000	810	100.00
285	0.850	460	6.000	616	16.000		
290	0.900	465	6.500	617	17.000		

**8 TERMINAL 6**

1 7	Stud 10-32	6 9	Stud M6
2 8	Screw 10-32	9 9	7/16" Clip Terminal
3 9	Stud 1/4-20	A 10	Plug-In Stud
4 8	Stud M5 x 0.8	C 8	5/16" Clip Terminal
5 8	Screw M5 x 0.8		

**9 ACTUATOR COLOR & LEGEND 11**

Actuator Color	ON-OFF	Dual	Legend Color
White	B	1	Black
Black	D	2	White
Red	G	3	White
Green	J	4	White
Blue	L	5	White
Yellow	N	6	Black
Gray	Q	7	Black
Orange	S	8	Black

**10 MOUNTING / BARRIERS**

MOUNTING STYLE	BARRIERS 12
<b>Threaded Insert</b>	
1 6-32 x 0.195 inches	yes
2 ISO M3 x 5mm	yes

**11 MAXIMUM APPLICATION RATING**

A	65 DC
B	125 DC
C	120/240 AC 2
D	240 AC
K	120 AC
F	277 AC
M	80 DC

**12 AGENCY APPROVAL 11**

A	without approvals
F	UL489 Listed, CSA Certified & VDE Certified
G	UL489 Listed & CSA Certified
J	UL489 Listed, CSA Certified & TUV Certified

Notes:

- Actuator Code:  
A: Handle tie pin spacer(s) and retainers provided assembled with multi-pole units.  
B: Handle located, as viewed from front of breaker in left pole. 2 pole maximum.  
S: Handle moves to mid-position only upon electrical trip of the breaker.  
T: Handle moves to mid-position and alarm switch activates only upon electrical trip of the breaker.
- Standard multipole units have all poles identical except when specifying auxiliary switch and/or mixed poles.  
2 & 3 pole circuit breakers required for 120/240 VAC (Maximum application rating code C) applications, have all poles identical except when specifying auxiliary / alarm switch which is normally supplied in extreme right pole per figure B. Terminal barriers are required on all multipole breakers.  
Third pole is for 120/240 VAC applications requiring neutral disconnect. The 3rd pole has the same construction as poles 1 & 2.
- On multi-pole breakers, one auxiliary switch is supplied, mounted in the extreme right pole.  
VDE approval on auxiliary switch codes 2, 3 & 4 only.  
Auxiliary / Alarm Switch with Independent Circuit ie: separate from breaker circuit, only available with circuit breakers rated 50 amp maximum at 80 VDC, 125 VDC, and 120 VAC. Auxiliary / Alarm Switch with Dependent Circuit ie: same as circuit breaker, is supplied from factory with common terminal of auxiliary / alarm switch connected to line terminal on 120/240 and 240 VAC ratings. Circuit breakers rated 120 VAC 50 amp maximum can be supplied with Auxiliary/Alarm switch common terminal connected to breaker line terminal. Consult factory for special catalog number.
- Available up to 50 amps maximum.
- Current ratings 71 - 100 with VDE approvals are available up to two poles maximum.
- Terminal Codes 9 & C are not VDE approved.
- Terminal Code 1 available to 60 amps maximum.
- Terminal Codes 2, 4, 5 & C available to 50 amps maximum.
- Terminal Codes 3, 6 & 9 available to 100 amps maximum.
- Terminal Code A available to 100 amps maximum.
- VDE and TUV approvals require Dual (I-O, ON-OFF) markings on all handles.
- Barriers supplied on multi-pole units only.

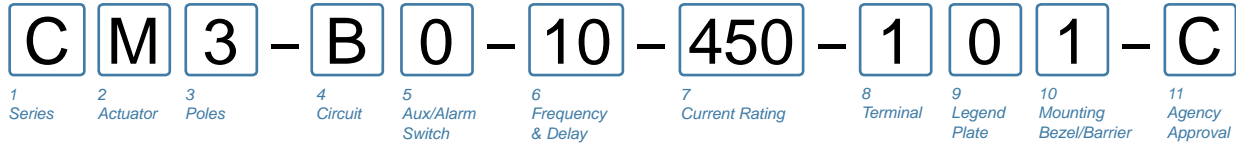

**1 SERIES**  
**C**

**2 ACTUATOR <sup>1</sup>**  
**M** Sealed Toggle, one per pole

**3 POLES**  
**1** One                      **2** Two                      **3** Three

**4 CIRCUIT**

<b>A</b> <sup>2</sup> Switch Only (no coil)	<b>F</b> <sup>3</sup> Relay Trip (current)
<b>B</b> Series Trip (current)	<b>G</b> <sup>3</sup> Relay Trip (voltage)
<b>C</b> Series Trip (voltage)	<b>H</b> <sup>3,4</sup> Dual Coil with Shunt Trip Voltage Coil
<b>D</b> <sup>3</sup> Shunt Trip (current)	<b>K</b> <sup>3,4</sup> Dual Coil with Relay Trip Voltage Coil
<b>E</b> <sup>3</sup> Shunt Trip (voltage)	

**5 AUXILIARY / ALARM SWITCH**

<b>0</b> without Aux Switch	<b>6</b> S.P.D.T., 0.139 Solder Lug
<b>2</b> S.P.D.T., 0.110 Q.C. Term.	<b>8</b> S.P.S.T., 0.187 Q.C. Term.
<b>3</b> S.P.D.T., 0.139 Solder Lug	<b>9</b> S.P.D.T., 0.187 Q.C. Term.
<b>4</b> S.P.D.T., 0.110 Q.C. Term. (Gold Contacts)	

**6 FREQUENCY & DELAY**

<b>03</b> <sup>2</sup> DC 50/60Hz, Switch Only	<b>30</b> DC 50/60Hz Instantaneous
<b>10</b> <sup>6</sup> DC Instantaneous	<b>31</b> DC 50/60Hz Ultra Short
<b>11</b> DC Ultra Short	<b>32</b> DC 50/60Hz Short
<b>12</b> DC Short	<b>34</b> DC 50/60Hz Medium
<b>14</b> DC Medium	<b>36</b> DC 50/60Hz Long
<b>16</b> DC Long	<b>42</b> <sup>7</sup> 50/60Hz Short, Hi-Inrush
<b>20</b> <sup>6</sup> 50/60Hz Instantaneous	<b>44</b> <sup>7</sup> 50/60Hz Medium, Hi-Inrush
<b>21</b> 50/60Hz Ultra Short	<b>46</b> <sup>7</sup> 50/60Hz Long, Hi-Inrush
<b>22</b> 50/60Hz Short	<b>52</b> <sup>7</sup> DC Short, Hi-Inrush
<b>24</b> 50/60Hz Medium	<b>54</b> <sup>7</sup> DC Medium, Hi-Inrush
<b>26</b> 50/60Hz Long	<b>56</b> DC Long, Hi-Inrush

- Notes:
- Actuator Code M: Handle location as viewed from front of breaker:  
 2 pole - right pole      3 pole - center pole
  - Switch Only circuits, rated up to 50 amps and 3 poles, and only available with VDE. For .02 to 30 amps, select Current Code 630. For 35 - 50 amps, select Current Code 650. For 55-70 amps, select Current Code 670. For 75-100 amps, select Current Code 810.
  - Circuit Codes D,E,F,G,H & K available with Terminal Codes 1,2,4 & 5 only.
  - Consult factory for available Dual Coil options, as special catalog number is required. Dual Coil Voltage Coils with Shunt Trip Construction trip instantaneously on line voltage. Dual Coil Voltage Coils require 30VA minimum power to trip instantaneously and are rated for intermittent duty only.
  - Auxiliary Switch available with Series Trip and Switch Only circuits. On multi-pole breakers, one auxiliary switch is supplied, mounted in the extreme right pole.
  - Voltage coils not rated for continuous duty. Available only with delay codes 10 & 20.
  - Available with Circuit Codes B & D only, and up to 50 amps maximum.
  - Consult factory for current ratings 71-100, in three pole units, available as special catalog number only.
  - Terminal Code 1 available to 60 amps maximum.
  - Terminal Codes 2, 4, 5 and C available to 50 amps maximum.
  - Terminal Codes 3, 6 & 9 available to 100 amps maximum.
  - Terminal Code 7 available to 25 amps maximum.
  - Terminal Code A available to 100 amps maximum.

**7 CURRENT RATING (AMPERES) <sup>9</sup>**

CODE	AMPERES				
<b>020</b>	0.020	<b>235</b>	0.350	<b>430</b>	3.000
<b>025</b>	0.025	<b>240</b>	0.400	<b>435</b>	3.500
<b>030</b>	0.030	<b>245</b>	0.450	<b>440</b>	4.000
<b>035</b>	0.035	<b>250</b>	0.500	<b>445</b>	4.500
<b>040</b>	0.040	<b>255</b>	0.550	<b>450</b>	5.000
<b>045</b>	0.045	<b>260</b>	0.600	<b>455</b>	5.500
<b>050</b>	0.050	<b>265</b>	0.650	<b>460</b>	6.000
<b>055</b>	0.055	<b>270</b>	0.700	<b>465</b>	6.500
<b>060</b>	0.060	<b>275</b>	0.750	<b>470</b>	7.000
<b>065</b>	0.065	<b>280</b>	0.800	<b>475</b>	7.500
<b>070</b>	0.070	<b>285</b>	0.850	<b>480</b>	8.000
<b>075</b>	0.075	<b>290</b>	0.900	<b>485</b>	8.500
<b>080</b>	0.080	<b>295</b>	0.950	<b>490</b>	9.000
<b>085</b>	0.085	<b>410</b>	1.000	<b>495</b>	9.500
<b>090</b>	0.090	<b>512</b>	1.250	<b>610</b>	10.000
<b>095</b>	0.095	<b>415</b>	1.500	<b>710</b>	10.500
<b>210</b>	0.100	<b>517</b>	1.750	<b>611</b>	11.000
<b>215</b>	0.150	<b>420</b>	2.000	<b>711</b>	11.500
<b>220</b>	0.200	<b>522</b>	2.250	<b>612</b>	12.000
<b>225</b>	0.250	<b>425</b>	2.500	<b>712</b>	12.500
<b>230</b>	0.300	<b>527</b>	2.750	<b>613</b>	13.000

**OR VOLTAGE COIL (NORMAL RATED VOLTAGE) <sup>7</sup>**

CODE	AMPERES				
<b>A06</b>	6 DC	<b>A32</b>	32 DC	<b>J12</b>	12 AC
<b>A12</b>	12 DC	<b>A48</b>	48 DC	<b>J18</b>	18 AC
<b>A18</b>	18 DC	<b>A65</b>	65 DC	<b>J24</b>	24 AC
<b>A24</b>	24 DC	<b>J06</b>	6 AC	<b>J48</b>	48 AC
				<b>J65</b>	65 AC
				<b>K20</b>	120 AC
				<b>L40</b>	240 AC

**8 TERMINAL**

<b>1</b> <sup>9</sup> Stud 10-32	<b>6</b> <sup>11</sup> Stud M6
<b>2</b> <sup>10</sup> Screw 10-32	<b>7</b> <sup>12</sup> 0.250 Double Click Connect
<b>3</b> <sup>11</sup> Stud 1/4-20	<b>9</b> <sup>11</sup> 7/16" Clip Terminal
<b>4</b> <sup>10</sup> Stud M5 x 0.8	<b>A</b> <sup>13</sup> Plug-In Stud
<b>5</b> <sup>10</sup> Screw M5 x 0.8	<b>C</b> <sup>10</sup> 5/16" Clip Terminal

**9 LEGEND PLATE**  
**0** No Legend

**10 MOUNTING / BARRIERS**

	MOUNTING STYLE	BARRIERS
<b>1</b>	Standard Hex Nut	no
<b>A</b>	Standard Hex Nut (multi-pole units only)	yes

**11 AGENCY APPROVAL**

<b>C</b>	UL Recognized & CSA Accepted
<b>I</b>	UL Recognized & CSA Accepted, UL1500 ignition protection
<b>L</b>	UL Recognized & CSA Accepted with listed construction



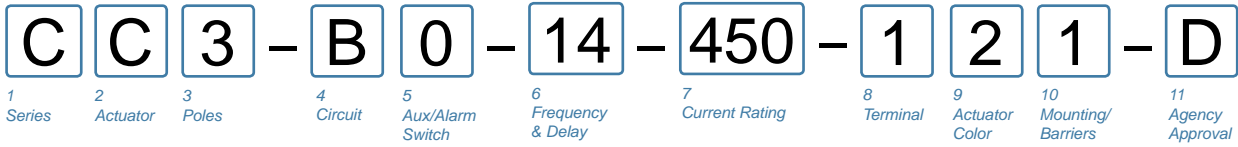

**1 SERIES**  
C

**2 ACTUATOR 1**  
*Two Color Visi-Rocker*

**ROCKER STYLE DESCRIPTIONS**

HORIZONTAL STYLE		VERTICAL STYLE	
INDICATE "ON" CODE "D"		INDICATE "ON" CODE "C"	
INDICATE "OFF" CODE "G", "O"		INDICATE "OFF" CODE "F", "N"	
SINGLE COLOR CODE "K", "U"		INDICATE "OFF" CODE "J", "R"	

**Two Color Visi-Rocker**

- C Indicate ON, vertical legend
- D Indicate ON, horizontal legend
- E Indicate ON, no legend
- F Indicate OFF, vertical legend
- G Indicate OFF, horizontal legend
- H Indicate OFF, no legend

**Push-To-Reset, Visi-Rocker**

- N Indicate OFF, vertical legend
- O Indicate OFF, horizontal legend
- P Indicate OFF, no legend

**Single color**

- J Vertical legend
- K Horizontal legend
- L No legend

**Push-To-Reset, Single color**

- R Vertical legend
- U Horizontal legend
- V No legend

**3 POLES 2**  
1 One                      2 Two                      3 Three

**4 CIRCUIT**

- A<sup>3</sup> Switch Only (No Coil)
- B Series Trip (Current)
- C Series Trip (Voltage)
- D<sup>4</sup> Shunt Trip (Current)
- E<sup>4</sup> Shunt Trip (Voltage)
- F<sup>4</sup> Relay Trip (Current)
- G<sup>4</sup> Relay Trip (Voltage)
- H<sup>4,5</sup> Dual Coil with Shunt Trip Voltage Coil
- K<sup>4,5</sup> Dual Coil with Relay Trip Voltage Coil

**5 AUXILIARY / ALARM SWITCH 6**

0 without Aux Switch	6 S.P.S.T., 0.139 Solder Lug
2 S.P.D.T., 0.110 Q.C. Term.	8 S.P.S.T., 0.187 Q.C. Term.
3 S.P.D.T., 0.139 Solder Lug	9 S.P.D.T., 0.187 Q.C. Term. (Gold Contacts)
4 S.P.D.T., 0.110 Q.C. Term. (Gold Contacts)	

**6 FREQUENCY & DELAY**

03 DC 50/60Hz, Switch Only	30 DC 50/60Hz Instantaneous
10 <sup>7</sup> DC Instantaneous	31 DC 50/60Hz Ultra Short
11 DC Ultra Short	32 DC 50/60Hz Short
12 DC Short	34 DC 50/60Hz Medium
14 DC Medium	36 DC 50/60Hz Long
16 DC Long	42 <sup>8</sup> 50/60Hz Short, Hi-Inrush
20 <sup>7</sup> 50/60Hz Instantaneous	44 <sup>8</sup> 50/60Hz Medium, Hi-Inrush
21 50/60Hz Ultra Short	46 <sup>8</sup> 50/60Hz Long, Hi-Inrush
22 50/60Hz Short	52 <sup>8</sup> DC Short, Hi-Inrush
24 50/60Hz Medium	54 <sup>8</sup> DC Medium, Hi-Inrush
26 50/60Hz Long	56 <sup>8</sup> DC Long, Hi-Inrush

Notes:  
1 Push-To-Reset actuators have OFF portion of rocker shrouded.  
2 Multi-pole breakers have all poles identical except when specifying Auxiliary switch and/or mixed poles, and have one rocker per breaker. Rocker location as viewed from front panel: 2 pole – left pole; 3 pole – center pole.  
3 Switch Only circuits, rated up to 50 amps and 3 poles, and only available with VDE Certification when tied to a protected pole (Circuit Code B, C, D or H.). For .02 to 30 amps, select Current Code 630. For 35 - 50 amps, select Current Code 650. For 55-70 amps, select Current Code 670. For 75-100 amps, select Current Code 810.  
4 Circuit Codes D,E,F,G,H & K available with Terminal Codes 1,2,4 & 5 only. Circuit Codes D,F,H & K available up to 50 amps maximum Current Rating.  
5 Consult factory for available Dual Coil options, as special catalog number is required. Dual Coil Voltage Coils with Shunt Trip Construction trip instantaneously on line voltage. Dual Coil Voltage Coils require 30VA minimum power to trip instantaneously and are rated for intermittent duty only.  
6 Auxiliary Switch available with Series Trip and Switch Only circuits. On multi-pole breakers, one auxiliary switch is supplied, mounted in the extreme right pole. Auxiliary switch codes 2, 3 & 4 are VDE approved.  
7 Voltage coils not rated for continuous duty. Available only with delay codes 10 & 20.  
8 Available with Circuit Codes B & D only, and up to 50 amps maximum.  
9 Current Ratings 60-70 are available up to four poles maximum. Ratings 71-100 are available up to two poles maximum.  
10 Terminal Code 1 available to 60 amps maximum.  
11 Terminal Codes 2,4,5 & C available to 50 amps maximum.  
12 Terminal Codes 3,6 & 9 available to 100 amps maximum.  
13 Terminal Code 7 available to 25 amps maximum.  
14 Terminal Code A available to 100 amps maximum.  
15 Terminal Codes 7, 9 & C are not VDE approved.  
16 Color shown is visi and legend with remainder of rocker black  
17 Legend on Push-to-reset bezel/shroud is white when single color rocker is ordered. Dual = ON-OFF/I-O legend with actuator codes C - G, and J, K, N, O, R, & U. None = no legend with actuator codes H, L, P, V. Rockerguard available with actuator codes C - L. Push-to-reset available with actuator codes N, O, P, R, U, V.  
18 VDE/TUV approval requires Dual (I-O, ON-OFF) or I-O markings on rocker.  
19 VDE/TUV: 30 amps max.; UL/CSA: 50 amps max.; Available in 2 - 4 poles only and limited to AC Delays. "General Purpose amps" not rated for "full load amps" or to be used in applications with a motor.

**7 CURRENT RATING (AMPERES)**

CODE	AMPERES	CODE	AMPERES	CODE	AMPERES	CODE	AMPERES
020	0.020	235	0.350	430	3.000	614	14.000
025	0.025	240	0.400	435	3.500	615	15.000
030	0.030	245	0.450	440	4.000	616	16.000
035	0.035	250	0.500	445	4.500	617	17.000
040	0.040	255	0.550	450	5.000	618	18.000
045	0.045	260	0.600	455	5.500	620	20.000
050	0.050	265	0.650	460	6.000	622	22.000
055	0.055	270	0.700	465	6.500	624	24.000
060	0.060	275	0.750	470	7.000	625	25.000
065	0.065	280	0.800	475	7.500	630	30.000
070	0.070	285	0.850	480	8.000	635	35.000
075	0.075	290	0.900	485	8.500	640	40.000
080	0.080	295	0.950	490	9.000	650	50.000
085	0.085	410	1.000	495	9.500	660 <sup>9</sup>	60.000
090	0.090	512	1.250	610	10.000	670 <sup>9</sup>	70.000
095	0.095	415	1.500	710	10.500	680 <sup>9</sup>	80.000
210	0.100	517	1.750	611	11.000	685 <sup>9</sup>	85.000
215	0.150	420	2.000	711	11.500	690 <sup>9</sup>	90.000
220	0.200	522	2.250	612	12.000	695 <sup>9</sup>	95.000
225	0.250	425	2.500	712	12.500	810 <sup>9</sup>	100.000
230	0.300	527	2.750	613	13.000		

**OR VOLTAGE COIL (NORMAL RATED VOLTAGE) 7**

CODE	AMPERES	CODE	AMPERES	CODE	AMPERES	CODE	AMPERES
A06	6 DC	A32	32 DC	J12	12 AC	J65	65 AC
A12	12 DC	A48	48 DC	J18	18 AC	K20	120 AC
A18	18 DC	A65	65 DC	J24	24 AC	L40	240 AC
A24	24 DC	J06	6 AC	J48	48 AC		

**8 TERMINAL**

1 <sup>10</sup> Stud 10-32	6 <sup>12</sup> Stud M6
2 <sup>11</sup> Screw 10-32	7 <sup>13</sup> 0.250 Double Quick Connect
3 <sup>12</sup> Stud 1/4-20	9 7/16" Clip Terminal
4 <sup>11</sup> Stud M5 x 0.8	A <sup>14</sup> Plug-In Stud
5 <sup>11</sup> Screw M5 x 0.8	C 5/16" Clip Terminal

**9 ACTUATOR COLOR & LEGEND 16,17,18**

Color:	I-O ON-OFF Dual/None			Marking Color:	Single Color Rocker/Handle	Visi-Rocker
	A	B	1			
White	A	B	1	Black	Black	White
Black	C	D	2	White	White	n/a
Red	F	G	3	White	White	Red
Green	H	J	4	White	White	Green
Blue	K	L	5	White	White	Blue
Yellow	M	N	6	Black	Black	Yellow
Gray	P	Q	7	Black	Black	Gray
Orange	R	S	8	Black	Black	Orange

**10 MOUNTING / BARRIERS 1**

STANDARD ROCKER BEZEL	BARRIERS	VOLTAGE
1 6-32 x 0.195 inches	no	<300
2 6-32 x 0.195 inches	yes	<300
3 <sup>19</sup> 6-32 x 0.195 inches	yes	≥300
4 ISO M3 x 5mm	no	<300
5 ISO M3 x 5mm	yes	<300
6 <sup>19</sup> ISO M3 x 5mm	yes	≥300
<b>ROCKERGARD BEZEL</b>		
A 6-32 x 0.195 inches	no	<300
C 6-32 x 0.195 inches	yes	<300
E <sup>19</sup> 6-32 x 0.195 inches	yes	≥300
G ISO M3 x 5mm	no	<300
J ISO M3 x 5mm	yes	<300
L <sup>19</sup> ISO M3 x 5mm	yes	≥300
<b>PUSH-TO-RESET BEZEL</b>		
B 6-32 x 0.195 inches	no	<300
D 6-32 x 0.195 inches	yes	<300
F <sup>19</sup> 6-32 x 0.195 inches	yes	≥300
H ISO M3 x 5mm	no	<300
J ISO M3 x 5mm	yes	<300
M <sup>19</sup> ISO M3 x 5mm	yes	≥300

**11 AGENCY APPROVAL**

- C UL Recognized & CSA Accepted
- D VDE Certified, UL Recognized & CSA Accepted
- E TUV Certified, UL Recognized & CSA Accepted
- H UL489 Construction: VDE Certified, UL Recognized & CSA Accepted
- I UL Recognized STD 1077, UL Recognized 1500 (ignition protected), & CSA Accepted
- L UL489 Construction: UL Recognized & CSA Accepted
- R UL489 Construction: TUV Certified, UL Recognized & CSA Accepted

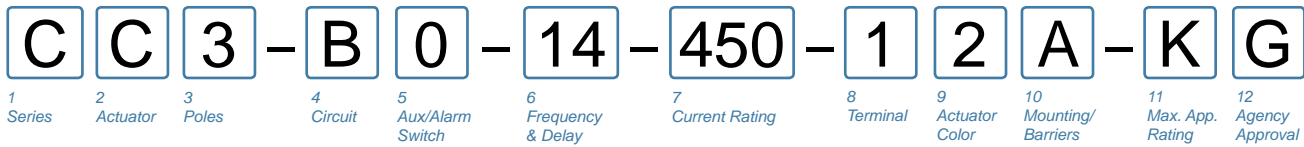

**1 SERIES**

**C**

**2 ACTUATOR 1**

**Two Color Visi-Rocker**

- C** Indicate ON, vertical legend
- D** Indicate ON, horizontal legend
- F** Indicate OFF, vertical legend
- G** Indicate OFF, horizontal legend
- Single color**
- J** Vertical legend
- K** Horizontal legend

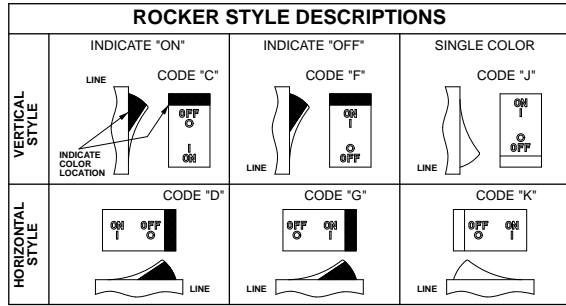

**3 POLES 1**

- 1** One
- 2** Two
- 3** Three

**4 CIRCUIT**

- B** Series Trip (current)

**5 AUXILIARY / ALARM SWITCH 2**

- 0** without Aux Switch
- 2** S.P.D.T., 0.110 Q.C. Term.
- 3** S.P.D.T., 0.139 Solder Lug
- 4** S.P.D.T., 0.110 Q.C. Term. (Gold Contacts)
- 6** S.P.S.T., 0.139 Solder Lug
- 8** S.P.S.T., 0.187 Q.C. Term.
- 9** S.P.D.T., 0.187 Q.C. Term.

**6 FREQUENCY & DELAY**

- 11** DC Ultra Short
- 12** DC Short
- 14** DC Medium
- 16** DC Long
- 21** 50/60Hz Ultra Short
- 22** 50/60Hz Short
- 24** 50/60Hz Medium
- 26** 50/60Hz Long
- 42** 50/60Hz Short, Hi-Inrush
- 44** 50/60Hz Medium, Hi-Inrush
- 46** 50/60Hz Long, Hi-Inrush
- 52** DC Short, Hi-Inrush
- 54** DC Medium, Hi-Inrush
- 56** DC Long, Hi-Inrush

**Notes:**

- 1 Multi-pole breakers have all breakers identical except when specifying Auxiliary switch and/or mixed poles, and have one rocker per breaker.
- 2 On multi-pole breakers, one auxiliary switch is supplied, mounted in the extreme right pole.
- 3 Available up to 50 amps maximum.
- 4 Current ratings 71 - 100 with VDE approvals are available up to two poles maximum.
- 5 Terminal Code 1 available to 60 amps maximum.
- 6 Terminal Codes 2, 4, 5 & C available to 50 amps maximum.
- 7 Terminal Codes 3, 6, 9 & A available to 100 amps maximum.
- 8 Terminal Codes 9 & C are not VDE approved.
- 9 Color shown is visi and legend with remainder of rocker black
- 10 Dual = ON-OFF/I-O legend on actuator.
- 11 VDE and TUV approval requires Dual (I-O, ON-OFF) markings on rocker.
- 12 Rockerguard available with all actuator codes.
- 13 Barriers supplied on multi-pole units only.
- 14 2 & 3 pole circuit breakers required for 120/240 AC rating.

**7 CURRENT RATING (AMPERES) 4**

CODE	AMPERES	CODE	AMPERES	CODE	AMPERES	CODE	AMPERES
210	0.100	295	0.950	470	7.000	618	18.000
215	0.150	410	1.000	475	7.500	620	20.000
220	0.200	512	1.250	480	8.000	622	22.000
225	0.250	415	1.500	485	8.500	624	24.000
230	0.300	517	1.750	490	9.000	625	25.000
235	0.350	420	2.000	495	9.500	630	30.000
240	0.400	522	2.250	610	10.000	635	35.000
245	0.450	425	2.500	710	10.500	640	40.000
250	0.500	527	2.750	611	11.000	650	50.000
255	0.550	430	3.000	711	11.500	660	60.000
260	0.600	435	3.500	612	12.000	670	70.000
265	0.650	440	4.000	712	12.500	680	80.000
270	0.700	445	4.500	613	13.000	685	85.000
275	0.750	450	5.000	614	14.000	690	90.000
280	0.800	455	5.500	615	15.000	695	95.000
285	0.850	460	6.000	616	16.000	810	100.00
290	0.900	465	6.500	617	17.000		

**8 TERMINAL**

- 1** 5 Stud 10-32
- 2** 6 Screw 10-32 with saddle & washer clamps
- 3** 7 Stud 1/4-20
- 4** 6 Stud M5 x 0.8
- 5** 6 Screw M5 x 0.8 with saddle & washer clamps
- 6** 7 Stud M6
- 9** 7,8 7/16" Clip Terminal
- A** 7,8 Plug-In Stud
- C** 6,8 5/16" Clip Terminal

**9 ACTUATOR COLOR & LEGEND 11**

Actuator or Visi-Color	Marking:	Marking Color:	Single Color	Rocker/Handle	Visi-Rocker
White	<b>B</b>	1	Black	Black	White
Black	<b>D</b>	2	White	White	n/a
Red	<b>G</b>	3	White	White	Red
Green	<b>J</b>	4	White	White	Green
Blue	<b>L</b>	5	White	White	Blue
Yellow	<b>N</b>	6	Black	Black	Yellow
Gray	<b>Q</b>	7	Black	Black	Gray
Orange	<b>S</b>	8	Black	Black	Orange

**10 MOUNTING / BARRIERS 12**

	Standard Rocker Bezel Threaded Insert, 2 per pole	BARRIERS 13
<b>A</b>	6-32 X 0.195 inches	yes
<b>C</b>	ISO M3 x 5mm	yes
	Rockerguard Bezel Threaded Insert, 2 per pole	
<b>B</b>	6-32 x 0.195 inches	yes
<b>D</b>	ISO M3 x 5mm	yes

**11 MAXIMUM APPLICATION RATING**

- A** 65 DC
- B** 125 DC
- C** 120/240 AC 14
- D** 240 AC
- F** 277 AC
- K** 120 AC
- M** 80 DC

**12 AGENCY APPROVAL**

- A** without approvals
- F** UL 489 Listed, CSA Certified, & VDE Certified
- G** UL 489 Listed & CSA Certified
- J** UL489 Listed, CSA Certified & TUV Certified

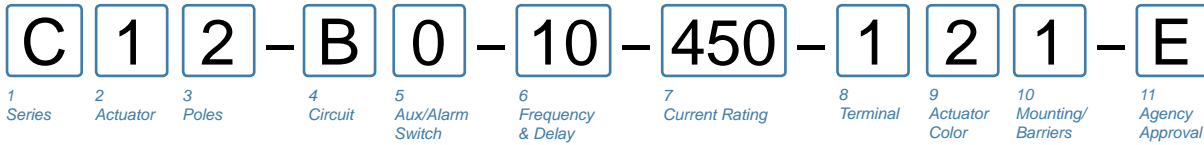

**1 SERIES**  
C

**2 ACTUATOR 1**  
**Two Color Visi-Rocker**

- 1 Indicate OFF, vertical legend
- 2 Indicate OFF, horizontal legend

**Single color**

- 3 Vertical legend
- 4 Horizontal legend

**Push-To-Reset, Visi-Rocker**

- 5 Indicate OFF, vertical legend
- 6 Indicate OFF, horizontal legend

**Push-To-Reset, Single color**

- 7 Vertical legend
- 8 Horizontal legend

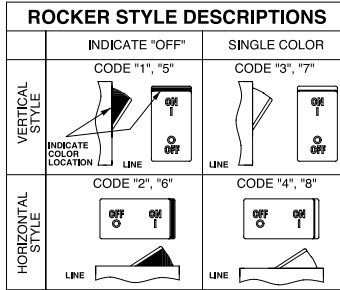

**3 POLES 2**

1 One	2 Two	3 Three
-------	-------	---------

**4 CIRCUIT**

A <sup>3</sup> Switch Only (No Coil)	F <sup>4</sup> Relay Trip (Current)
B Series Trip (Current)	G <sup>4</sup> Relay Trip (Voltage)
C Series Trip (Voltage)	H <sup>4,5</sup> Dual Coil with Shunt Trip Voltage Coil
D <sup>4</sup> Shunt Trip (Current)	K <sup>4,5</sup> Dual Coil with Relay Trip Voltage Coil
E <sup>4</sup> Shunt Trip (Voltage)	

**5 AUXILIARY / ALARM SWITCH 6**

0 without Aux Switch	6 S.P.D.T., 0.139 Solder Lug
2 S.P.D.T., 0.110 Q.C. Term.	8 S.P.S.T., 0.187 Q.C. Term.
3 S.P.D.T., 0.139 Solder Lug	9 S.P.D.T., 0.187 Q.C. Term.
4 S.P.D.T., 0.110 Q.C. Term. (Gold Contacts)	

**6 FREQUENCY & DELAY**

03 DC 50/60Hz, Switch Only	30 DC 50/60Hz Instantaneous
10 7 DC Instantaneous	31 DC 50/60Hz Ultra Short
11 DC Ultra Short	32 DC 50/60Hz Short
12 DC Short	34 DC 50/60Hz Medium
14 DC Medium	36 DC 50/60Hz Long
16 DC Long	42 <sup>8</sup> 50/60Hz Short, Hi-Inrush
20 7 50/60Hz Instantaneous	44 <sup>8</sup> 50/60Hz Medium, Hi-Inrush
21 50/60Hz Ultra Short	46 <sup>8</sup> 50/60Hz Long, Hi-Inrush
22 50/60Hz Short	52 <sup>8</sup> DC Short, Hi-Inrush
24 50/60Hz Medium	54 <sup>8</sup> DC Medium, Hi-Inrush
26 50/60Hz Long	56 <sup>8</sup> DC Long, Hi-Inrush

- Notes:
- 1 Push-to-reset actuators have OFF portion of rocker shrouded.
  - 2 Multi-pole breakers have all poles identical except when specifying Auxiliary switch and/or mixed poles, and have one rocker per breaker. Rocker location as viewed from front panel: 2 pole – left pole; 3 pole – center pole.
  - 3 Switch Only circuits, rated up to 50 amps and 3 poles, and only available with VDE Certification when tied to a protected pole (Circuit Code B, C, D or H.). For .02 to 30 amps, select Current Code 630. For 35 - 50 amps, select Current Code 650. For 55-70 amps, select Current Code 670. For 75-100 amps, select Current Code 810.
  - 4 Circuit Codes D,E,F,G,H & K available with Terminal Codes 1,2,4 & 5 only. Circuit Codes D,F,H & K available up to 50 amps maximum Current Rating.
  - 5 Consult factory for available Dual Coil options, as special catalog number is required. Dual Coil Voltage Coils with Shunt Trip Construction trip instantaneously on line voltage. Dual Coil Voltage Coils require 30VA minimum power to trip instantaneously and are rated for intermittent duty only.
  - 6 Auxiliary Switch available with Series Trip and Switch Only circuits. On multi-pole breakers, one auxiliary switch is supplied, mounted in the extreme right pole. Auxiliary switch codes 2, 3 & 4 are VDE approved.
  - 7 Voltage coils not rated for continuous duty. Available only with delay codes 10 and 20.
  - 8 Available with Circuit Codes B & D only, and up to 50 amps maximum.
  - 9 Current ratings 60-70 are available up to four poles maximum. Current ratings 71 - 100 are available up to two poles maximum.
  - 10 Terminal Code 1 available to 60 amps maximum.
  - 11 Terminal Codes 2,4,5 & C available to 50 amps maximum.
  - 12 Terminal Codes 3,6 & 9 available to 100 amps maximum.
  - 13 Terminal Code 7 available to 25 amps maximum.
  - 14 Terminal Code A available to 100 amps maximum.
  - 15 Terminal Codes 7, 9 & C are not VDE approved.
  - 16 Color shown is visi & legend with remainder of rocker black. Dual = ON-OFF/I-O legend.
  - 17 Legend on Push-to-reset bezel/shroud is white with single color actuator codes 7 & 8. Legend on Push-to-reset bezel/shroud matches visi-color of rocker with actuator codes 5 & 6.
  - 18 VDE/TUV approval requires Dual (I-O, ON-OFF) or I-O markings on rocker.
  - 19 VDE/TUV: 30 amps max.; UL/CSA: 50 amps max.; Available in 2 & 3 poles only and limited to AC Delays. "General Purpose amps" not rated for "full load amps" or to be used in applications with a motor.
  - 20 Recessed "OFF SIDE" available with actuator codes 1,2,3&4. Legends on rocker are available in ink stamping only.

**7 CURRENT RATING (AMPERES) 9**

CODE	AMPERES	CODE	AMPERES	CODE	AMPERES	CODE	AMPERES
020	0.020	235	0.350	430	3.000	614	14.000
025	0.025	240	0.400	435	3.500	615	15.000
030	0.030	245	0.450	440	4.000	616	16.000
035	0.035	250	0.500	445	4.500	617	17.000
040	0.040	255	0.550	450	5.000	618	18.000
045	0.045	260	0.600	455	5.500	620	20.000
050	0.050	265	0.650	460	6.000	622	22.000
055	0.055	270	0.700	465	6.500	624	24.000
060	0.060	275	0.750	470	7.000	625	25.000
065	0.065	280	0.800	475	7.500	630	30.000
070	0.070	285	0.850	480	8.000	635	35.000
075	0.075	290	0.900	485	8.500	640	40.000
080	0.080	295	0.950	490	9.000	650	50.000
085	0.085	410	1.000	495	9.500	660 <sup>9</sup>	60.000
090	0.090	512	1.250	610	10.000	670 <sup>9</sup>	70.000
095	0.095	415	1.500	710	10.500	680 <sup>9</sup>	80.000
210	0.100	517	1.750	611	11.000	685 <sup>9</sup>	85.000
215	0.150	420	2.000	711	11.500	690 <sup>9</sup>	90.000
220	0.200	522	2.250	612	12.000	695 <sup>9</sup>	95.000
225	0.250	425	2.500	712	12.500	810 <sup>9</sup>	100.000
230	0.300	527	2.750	613	13.000		

**OR VOLTAGE COIL (NORMAL RATED VOLTAGE) 7**

CODE	AMPERES	CODE	VOLTS	CODE	VOLTS	CODE	VOLTS
A06	6 DC	A32	32 DC	J12	12 AC	J65	65 AC
A12	12 DC	A48	48 DC	J18	18 AC	K20	120 AC
A18	18 DC	A65	65 DC	J24	24 AC	L40	240 AC
A24	24 DC	J06	6 AC	J48	48 AC		

**8 TERMINAL**

1 <sup>10</sup> Stud 10-32	6 <sup>12</sup> Stud M6
2 <sup>11</sup> Screw 10-32	7 <sup>13</sup> 0.250 Double Quick Connect
3 <sup>12</sup> Stud 1/4-20	9 <sup>15</sup> 7/16" Clip Terminal
4 <sup>11</sup> Stud M5 x 0.8	A <sup>14</sup> Plug-In Stud
5 <sup>11</sup> Screw M5 x 0.8	C <sup>15</sup> 5/16" Clip Terminal

**9 ACTUATOR COLOR & LEGEND 16,17,18**

**Actuator or**

Visi-Color	Marking:	Marking Color:	Single Color	Visi-Rocker
<b>Color:</b>	<b>I-O ON-OFF</b>	<b>Dual/None</b>	<b>Rocker/Handle</b>	<b>Visi-Rocker</b>
White	A B	1	Black	White
Black	C D	2	White	n/a
Red	F G	3	White	Red
Green	H J	4	White	Green
Blue	K L	5	White	Blue
Yellow	M N	6	Black	Yellow
Gray	P Q	7	Black	Gray
Orange	R S	8	Black	Orange

**10 MOUNTING / BARRIERS 1**

	STANDARD ROCKER BEZEL	BARRIERS	VOLTAGE
1	6-32 x 0.195 inches	no	<300
2	6-32 x 0.195 inches	yes	<300
3 <sup>19</sup>	6-32 x 0.195 inches	yes	≥300
4	ISO M3 x 5mm	no	<300
5	ISO M3 x 5mm	yes	<300
6 <sup>19</sup>	ISO M3 x 5mm	yes	≥300
<b>RECESSED OFF ROCKER</b>			
7	6-32 x 0.195 inches	no	<300
8	6-32 x 0.195 inches	yes	<300
9	6-32 x 0.195 inches	yes	≥300
A	ISO M3 x 5mm	no	<300
C	ISO M3 x 5mm	yes	<300
E	ISO M3 x 5mm	yes	≥300
<b>PUSH-TO-RESET BEZEL</b>			
B	6-32 x 0.195 inches	no	<300
D	6-32 x 0.195 inches	yes	<300
F <sup>19</sup>	6-32 x 0.195 inches	yes	≥300
H	ISO M3 x 5mm	no	<300
J	ISO M3 x 5mm	yes	<300
M <sup>19</sup>	ISO M3 x 5mm	yes	≥300

**11 AGENCY APPROVAL**

C	UL Recognized & CSA Accepted
E	TUV Certified, UL Recognized & CSA Accepted
I	UL Recognized STD 1077, UL Recognized 1500 (ignition protected), & CSA Accepted
L	UL489 Construction: UL Recognized & CSA Accepted
R	UL489 Construction: TUV Certified, UL Recognized & CSA Accepted

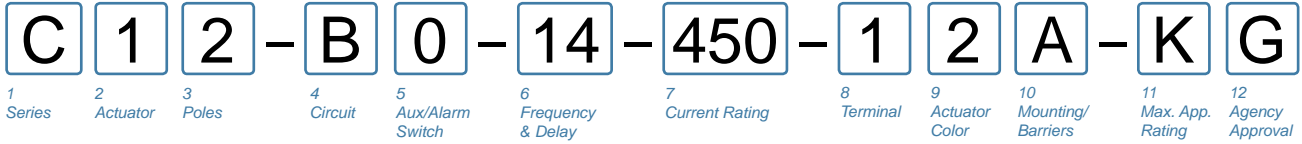

**1 SERIES**  
C

**2 ACTUATOR <sup>1</sup>**

**Two Color Visi-Rocker**

- 1 Indicate OFF, vertical legend
- 2 Indicate OFF, horizontal legend
- 3 Vertical legend
- 4 Horizontal legend

**Push-To-Reset, Visi-Rocker**

- 5 Indicate OFF, vertical legend
- 6 Indicate OFF, horizontal legend
- 7 Vertical legend
- 8 Horizontal legend

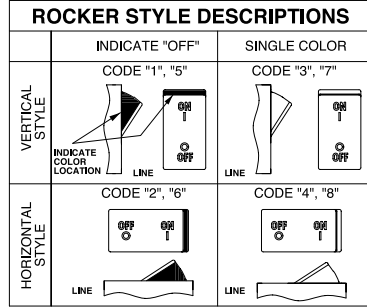

**3 POLES <sup>2</sup>**

- 1 One
- 2 Two
- 3 Three

**4 CIRCUIT**

- B Series Trip (current)

**5 AUXILIARY / ALARM SWITCH <sup>2</sup>**

- 0 without Aux Switch
- 2 S.P.D.T., 0.110 Q.C. Term.
- 3 S.P.D.T., 0.139 Solder Lug
- 4 S.P.D.T., 0.110 Q.C. Term. (Gold Contacts)
- 6 S.P.S.T., 0.139 Solder Lug
- 8 S.P.S.T., 0.187 Q.C. Term.
- 9 S.P.D.T., 0.187 Q.C. Term.

**6 FREQUENCY & DELAY**

- 11 DC Ultra Short
- 12 DC Short
- 14 DC Medium
- 16 DC Long
- 21 50/60Hz Ultra Short
- 22 50/60Hz Short
- 24 50/60Hz Medium
- 26 50/60Hz Long
- 42 <sup>4</sup> 50/60Hz Short, Hi-Inrush
- 44 <sup>4</sup> 50/60Hz Medium, Hi-Inrush
- 46 <sup>4</sup> 50/60Hz Long, Hi-Inrush
- 52 <sup>4</sup> DC Short, Hi-Inrush
- 54 <sup>4</sup> DC Medium, Hi-Inrush
- 56 <sup>4</sup> DC Long, Hi-Inrush

1 Notes:  
 2 Push-to-reset actuators have OFF portion of rocker shrouded.  
 3 Multi-pole breakers have all breakers identical except when specifying Auxiliary switch and/or mixed poles, and have one rocker per breaker.  
 4 On multi-pole breakers, one auxiliary switch is supplied, mounted in the extreme right pole.  
 5 Available up to 50 amps maximum.  
 6 Current ratings 71 - 100 with VDE approvals are available up to two poles maximum.  
 7 Terminal Code 1 available to 60 amps maximum.  
 8 Terminal Codes 2, 4, 5 & C available to 50 amps maximum.  
 9 Terminal Codes 3, 6, 9 & A available to 100 amps maximum.  
 10 Terminal Codes 9 & C are not VDE approved.  
 11 Color shown is visi and legend with remainder of rocker black  
 12 Dual = ON-OFF/I-O legend on actuator.  
 13 VDE and TUV approval requires Dual (I-O, ON-OFF) markings on rocker.  
 14 Legend on push-to-reset bezel/shroud is white when single color rocker is ordered. Legend on push-to-reset bezel/shroud matches visi-color of rocker with actuator codes  
 15 5 & 6.  
 16 Recessed "OFF-SIDE" available with actuator codes 1, 2, 3, & 4. Legends on rocker are available in ink stamping only.  
 17 Barriers supplied on multi-pole units only.  
 18 2 & 3 pole circuit breakers required for 120/240 AC rating.

**7 CURRENT RATING (AMPERES) <sup>5</sup>**

CODE	AMPERES	CODE	AMPERES	CODE	AMPERES	CODE	AMPERES
210	0.100	295	0.950	470	7.000	618	18.000
215	0.150	410	1.000	475	7.500	620	20.000
220	0.200	512	1.250	480	8.000	622	22.000
225	0.250	415	1.500	485	8.500	624	24.000
230	0.300	517	1.750	490	9.000	625	25.000
235	0.350	420	2.000	495	9.500	630	30.000
240	0.400	522	2.250	610	10.000	635	35.000
245	0.450	425	2.500	710	10.500	640	40.000
250	0.500	527	2.750	611	11.000	650	50.000
255	0.550	430	3.000	711	11.500	660	60.000
260	0.600	435	3.500	612	12.000	670	70.000
265	0.650	440	4.000	712	12.500	680	80.000
270	0.700	445	4.500	613	13.000	685	85.000
275	0.750	450	5.000	614	14.000	690	90.000
280	0.800	455	5.500	615	15.000	695	95.000
285	0.850	460	6.000	616	16.000	810	100.00
290	0.900	465	6.500	617	17.000		

**8 TERMINAL**

- 1 <sup>7</sup> Stud 10-32
- 2 <sup>8</sup> Screw 10-32
- 3 <sup>9</sup> Stud 1/4-20
- 4 <sup>8</sup> Stud M5 x 0.8
- 5 <sup>8</sup> Screw M5 x 0.8
- 6 <sup>9</sup> Stud M6
- 9 <sup>9,10</sup> 7/16" Clip Terminal
- A <sup>9</sup> Plug-In Stud
- C <sup>8,10</sup> 5/16" Clip Terminal

**9 ACTUATOR COLOR & LEGEND <sup>12</sup>**

Actuator or Visi-Color	Marking:	Marking Color:
<b>Color:</b> White Black Red Green Blue Yellow Gray Orange	<b>ON-OFF</b>	<b>Single Color</b>
	<b>Dual <sup>11</sup></b>	<b>Rocker/Handle</b>
	<b>1</b>	Black
	<b>2</b>	White
	<b>3</b>	White
	<b>4</b>	White
	<b>5</b>	White
	<b>6</b>	Black
<b>7</b>	Black	
<b>8</b>	Black	
		<b>Visi-Rocker</b>
		White
		n/a
		Red
		Green
		Blue
		Yellow
		Gray
		Orange

**10 MOUNTING / BARRIERS <sup>12</sup>**

	STANDARD ROCKER BEZEL Threaded Insert, 2 per pole	BARRIERS <sup>15</sup>
A	6-32 X 0.195 inches	yes
C	ISO M3 x 5mm	yes
	<b>RECESSED OFF ROCKER <sup>14</sup></b> Threaded Insert, 2 per pole	
E	6-32 x 0.195 inches	yes
F	ISO M3 x 5mm	yes
	<b>PUSH-TO-RESET BEZEL <sup>13</sup></b> Threaded Insert, 2 per pole	
B	6-32 x 0.195 inches	yes
D	ISO M3 x 5mm	yes

**11 MAXIMUM APPLICATION RATING**

- A 65 DC
- B 125 DC
- C 120/240 AC <sup>16</sup>
- D 240 AC
- F 277 AC
- K 120 AC
- M 80 DC

**12 AGENCY APPROVAL**

- A without approvals
- G UL 489 Listed & CSA Certified
- J UL489 Listed, CSA Certified & TUV Certified

## Circuit & Terminal Diagrams: in. [mm]

DESCRIPTION	CODE	DIMENSIONAL DETAIL	RATING (AMPS)		
			25	50	100
#10-32 STUD	1				
M5 STUD	4				
#1/4-20 STUD	3				
M6 STUD	6				
#1/4-20 STUD	3				
M6 STUD	6				
#10-32 SCREW	2				
M-5 SCREW	5				

DESCRIPTION	CODE	DIMENSIONAL DETAIL	RATING (AMPS)		
			25	50	100
.250 DOUBLE Q.C.	7				
7/16" CLIP TERMINALS	9				
PUSH-IN STUD	A				

NOTES: TOLERANCE ON STUD LENGTHS IS ±.031 [±.79] UNLESS OTHERWISE SPECIFIED.

### AUXILIARY / ALARM SWITCH TERMINAL DETAIL<sup>3</sup>

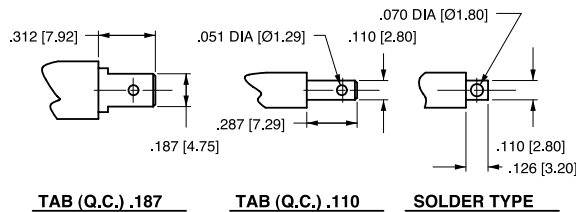

TIGHTENING TORQUE SPECIFICATIONS	
THREAD SIZE	TORQUE
#6-32 [M3] MOUNTING INSERTS	7-9 IN-LBS [0.8-1.0 NM]
#10-32 & M5 THD STUDS	15-20 IN-LBS [1.7-2.3 NM]
#10-32 THD SCREW	15-20 IN-LBS [1.7-2.3 NM]
#1/4-20 & M6 THD STUDS	30-35 IN-LBS [3.4-4.0 NM]

TERMINAL HARDWARE				
TERMINAL DESCRIPTION	CODE	AGENCY APPROVAL	AMPERE RATING	HARDWARE SUPPLIED
#10-32 STUD	1	ALL	.02 - 50	LOCK WASHER - FLAT WASHER - NUT
M5 STUD	4	ALL	.02 - 50	LOCK WASHER - FLAT WASHER - NUT
#1/4-20 STUD	3	ALL	.02 - 80	LOCK WASHER - FLAT WASHER - NUT
			81 - 100	LOCK WASHER - NUT - (2)FLAT WASHER - NUT
M6 STUD	6	ALL	.02 - 80	LOCK WASHER - FLAT WASHER - NUT
			81 - 100	LOCK WASHER - NUT - (2)FLAT WASHER - NUT
#10-32 SCREW	2 & 5	UL RECOGNIZED	.02 - 50	* SADDLE CLAMP - FLAT WASHER - SCREW
		UL-489 LISTED	.02 - 50	LOCK WASHER - FLAT WASHER - SCREW
		TUV & VDE CERTIFIED	.02 - 16	* SADDLE CLAMP - FLAT WASHER - SCREW
		TUV & VDE CERTIFIED	16.1 - 50	LOCK WASHER - FLAT WASHER - SCREW

\* THE SADDLE CLAMP IS FOR DIRECT WIRE CONNECTION USE. DISCARD SADDLE CLAMP IF WIRE TERMINAL LUG IS USED

Notes:

- All dimensions are in inches [millimeters].
- Tolerance ±.020 [.51] unless otherwise specified.
- Available on Series Trip and Switch Only Circuits when called for on multi-pole units. Only one auxiliary switch is normally supplied, as viewed in multi-pole identification scheme.

## Circuit & Terminal Diagrams: in. [mm]

	CIRCUIT SCHEMATIC		CIRCUIT CODE	AUX SWITCH CODE	CIRCUIT SCHEMATIC		CIRCUIT CODE	AUX SWITCH CODE				
	ANSI	IEC			ANSI	IEC						
	SWITCH ONLY (NO COIL)				SERIES TRIP							
	SWITCH ONLY (NO COIL) WITH AUXILIARY SWITCH		A	0	SERIES TRIP WITH AUXILIARY / ALARM SWITCH		B	0				
	SHUNT TRIP				DUAL COIL; SERIES TRIP CURRENT COIL, SHUNT TRIP VOLTAGE COIL				D	E	H	0
RELAY TRIP		DUAL COIL; SERIES TRIP CURRENT COIL, RELAY TRIP VOLTAGE COIL										
						F	G	K				

HANDLE POSITION VS. AUX/ALARM SWITCH MODE					
CIRCUIT BREAKER MODE	STANDARD C/B		MID TRIP C/B		
	HANDLE POSITION	AUX. SWITCH MODE	HANDLE POSITION	STANDARD ALARM SWITCH MODE	REVERSE ALARM SWITCH MODE <sup>1</sup>
OFF					
ON					
ELECTRICAL TRIP					

- Notes:
- 1 All dimensions are in inches [millimeters].
  - 2 Tolerance  $\pm .020$  [.51] unless otherwise specified.
  - 3 Schematic shown represents current trip circuits.
  - 4 Available only as special catalog number.

## Dimensional Specifications: in. [mm]

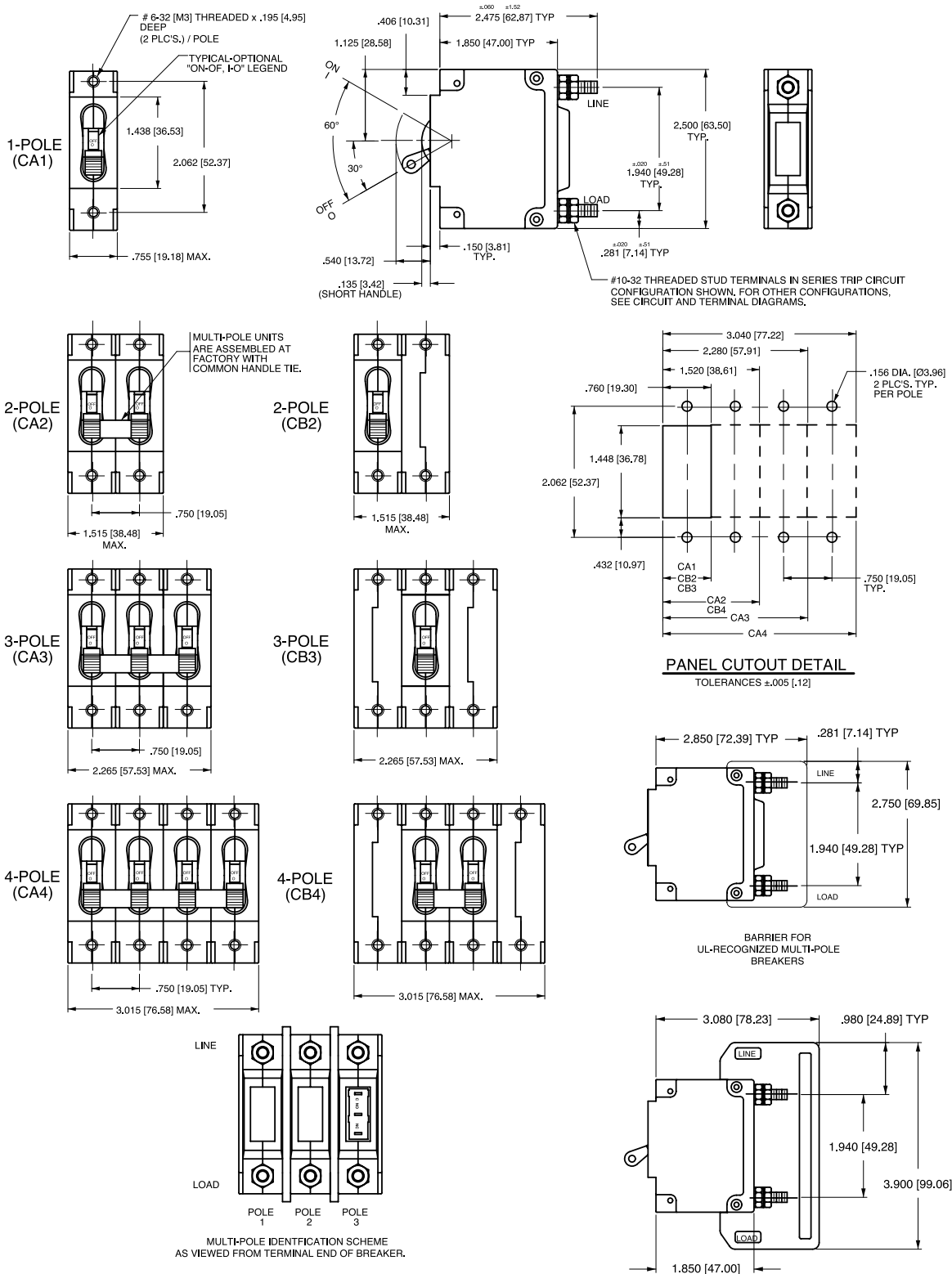

- Notes:
- 1 All dimensions are in inches [millimeters].
  - 2 Tolerance ±.020 [0.51] unless otherwise specified.

## Dimensional Specifications: in. [mm]

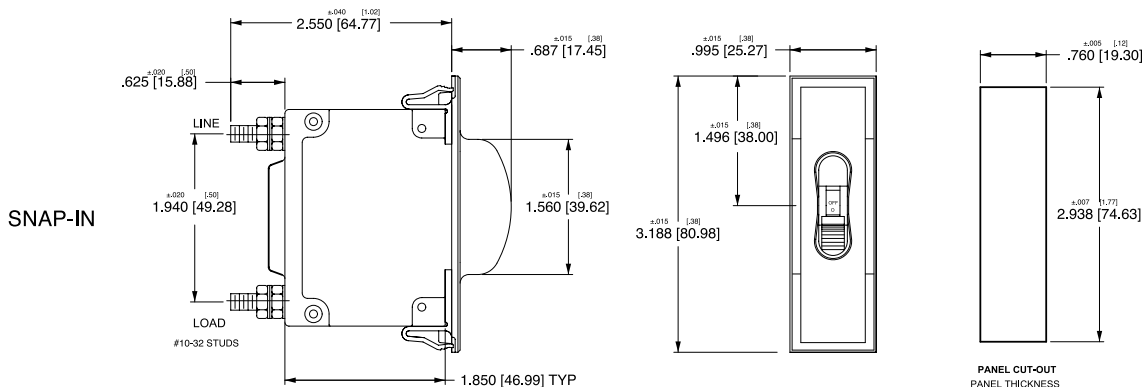
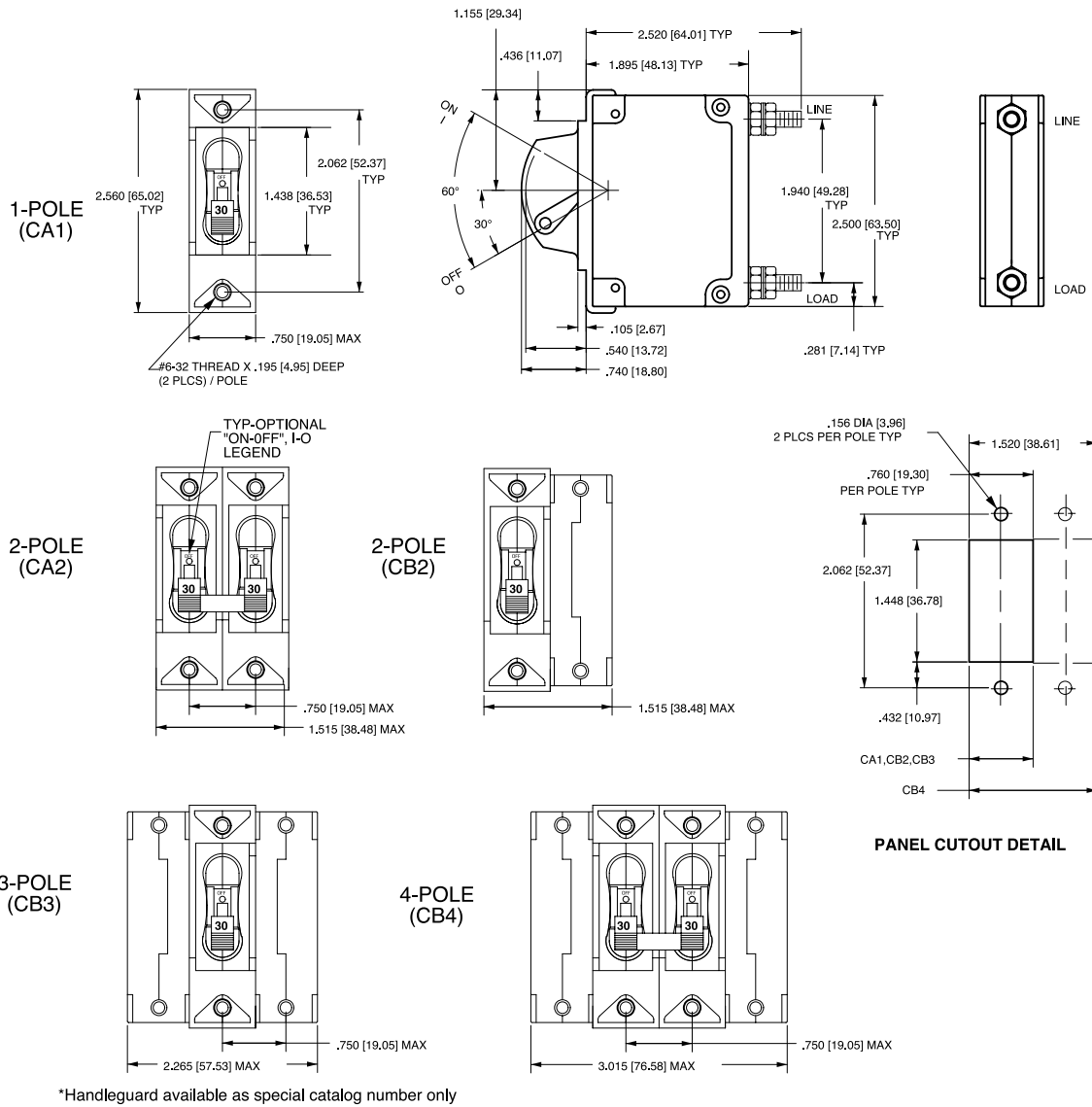

- Notes:  
 1 All dimensions are in inches [millimeters].  
 2 Tolerance  $\pm 0.020$  [.51] unless otherwise specified.



## Dimensional Specifications: in. [mm]

1-POLE (CA1)  
w/ ARC CHUTE BARRIER

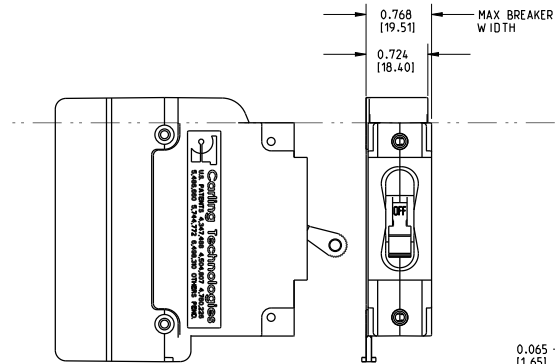

3-POLE (CA3)  
w/ ARC CHUTE BARRIER

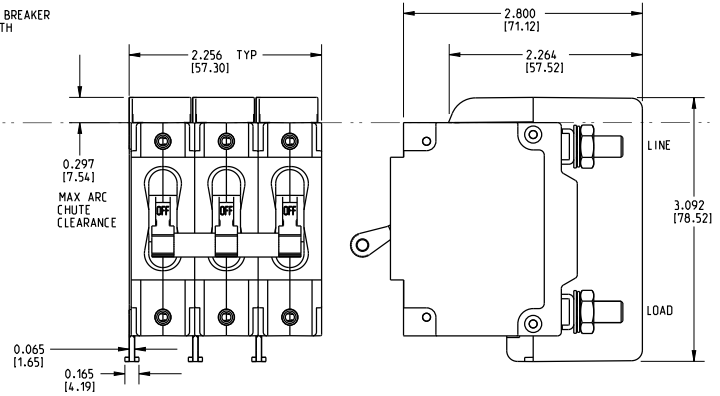

INDICATE "ON"

1-POLE (CC1, CD1)  
w/ ARC CHUTE (NO BARRIER)

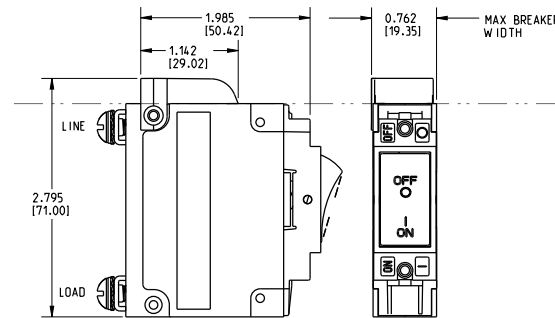

3-POLE (CC3, CD3)  
w/ ARC CHUTE BARRIER

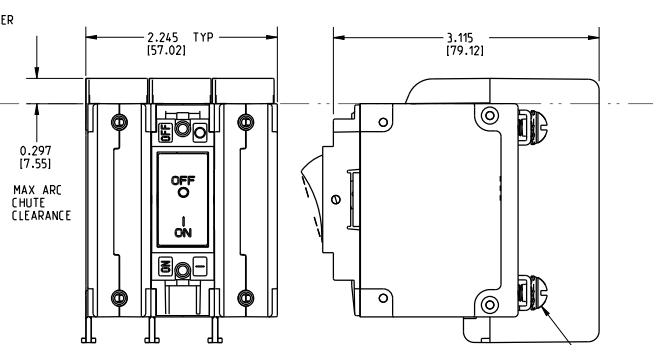

SCREW TYPE TERMINALS IN SERIES TRIP CIRCUIT CONFIGURATION SHOWN.

INDICATE "OFF" / SINGLE COLOR

1-POLE (CF1, CG1, C11, C21)  
w/ ARC CHUTE (NO BARRIER)

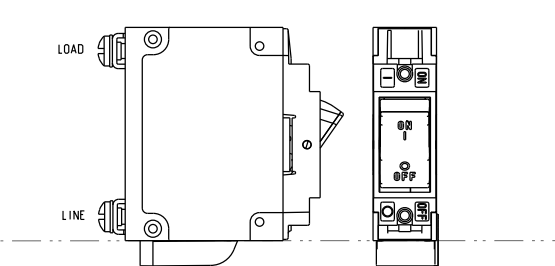

3-POLE (CF3, CG3, C13, C23)  
w/ ARC CHUTE BARRIER

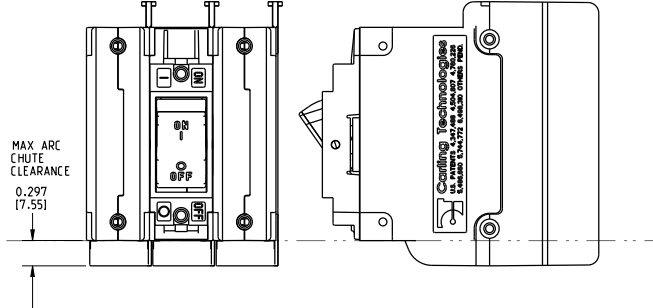

Notes:

- 1 Only 1-pole and 3-pole configurations shown. Arc chute (without barrier) and arc chute barrier also available for 2-pole construction.
- 2 Dimensions apply to all variations shown.
- 3 Notice that line and load terminal orientation for indicate on and indicate off rocker circuit breakers are opposite.
- 4 Screw type terminals shown for Rocker style (CF1, C11, etc) circuit breakers. For other terminal configurations see circuit and terminal diagrams.
- 5 All dimensions are in inches [millimeters].
- 6 Tolerance  $\pm .020$  unless otherwise specified.
- 7 Must be ordered under a special catalog number.

## Dimensional Specifications: in. [mm]

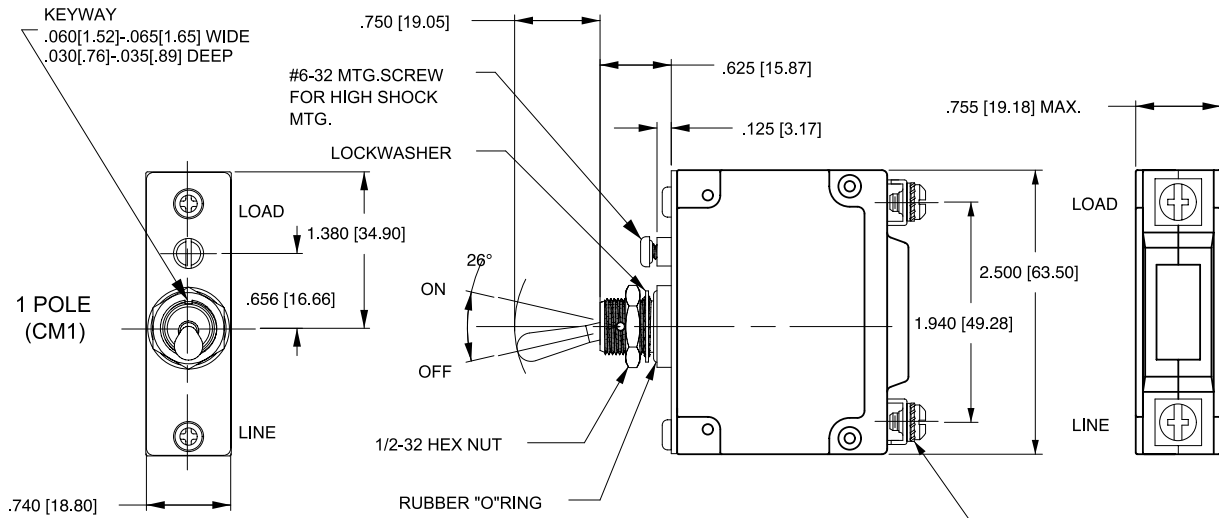

SCREW TYPE TERMINALS IN SERIES TRIP CIRCUIT CONFIGURATION SHOWN. FOR OTHER CONFIGURATIONS SEE CIRCUIT & TERMINAL DIAGRAMS

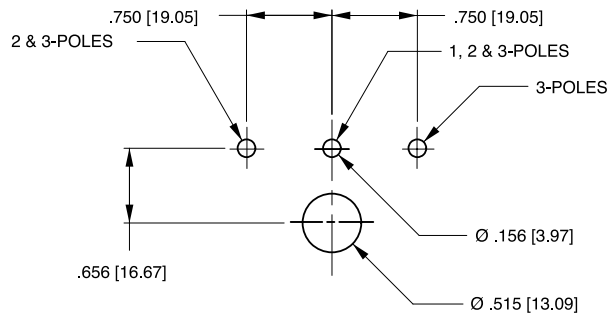
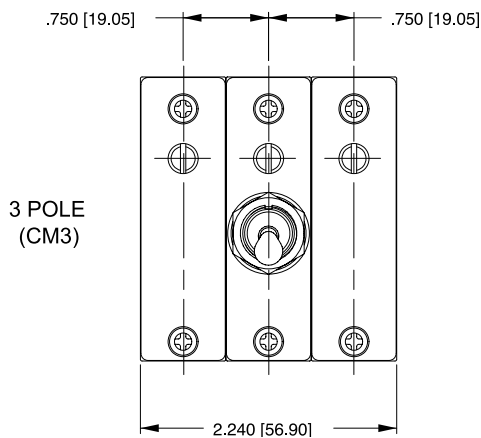
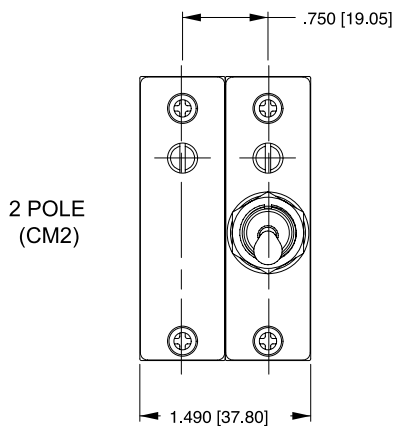

PANEL CUTOUT DETAIL  
 TOLERANCES ±.005[.13]

Notes:

- 1 All dimensions are in inches [millimeters].
- 2 Tolerance ±.020 [.51] unless otherwise specified.

## Circuit & Terminal Diagrams: in. [mm]

CIRCUIT BREAKER PROFILE	CIRCUIT SCHEMATIC		CIRCUIT CODE	AUX SWITCH CODE	CIRCUIT SCHEMATIC		CIRCUIT CODE	AUX SWITCH CODE
	ANSI	IEC			ANSI	IEC		
<p>2.160 [54.86] TYP</p> <p>LINE</p> <p>MAIN TERM'S. (SEE TABLE A)</p> <p>LOAD</p> <p>±.031 [.79] TYP</p> <p>.625 [15.88] TYP</p> <p>SERIES TRIP (2 TERM'S.)</p>	<p>SWITCH ONLY (NO COIL)</p> <p>ANSI: LINE, LOAD</p> <p>IEC: LINE (NETZ), LOAD (LAST)</p>		A	0	<p>SWITCH TRIP</p> <p>ANSI: LINE, LOAD</p> <p>IEC: LINE (NETZ) (3), LOAD (LAST)</p>		BC	0
<p>.675 [17.15] TYP</p> <p>.970 [24.64]</p> <p>C</p> <p>NO</p> <p>NC</p> <p>1.265 [32.13]</p> <p>AUX. SWITCH TERM'S. (3 PLCS.)</p> <p>SERIES TRIP W/AUX. SWITCH (5 TERM'S.)</p>	<p>SWITCH ONLY (NO COIL) WITH AUXILIARY SWITCH</p> <p>ANSI: LINE, LOAD, C, NO, NC</p> <p>IEC: LINE (NETZ), LOAD (LAST), C, NO, NC</p>		A	2 3 4	<p>SERIES TRIP WITH AUXILIARY SWITCH</p> <p>ANSI: LINE, LOAD, C, NO, NC</p> <p>IEC: LINE (NETZ) (3), LOAD (LAST), C, NO, NC</p>		BC	2 3 4
<p>SERIES TRIP (3 TERM'S.)</p>	<p>SHUNT TRIP</p> <p>ANSI: LINE, SHUNT, LOAD</p> <p>IEC: LINE (NETZ) (3), SHUNT (NEBENSCHLUSS), LOAD (LAST)</p>		DE	0	<p>DUAL COIL: SERIES TRIP CURRENT COIL, SHUNT TRIP VOLTAGE COIL</p> <p>ANSI: LINE, SHUNT, LOAD, VOLTAGE COIL</p> <p>IEC: LINE (NETZ), SHUNT, LOAD (LAST), VOLTAGE COIL</p>		H	0
<p>①</p> <p>②</p> <p>③</p> <p>④</p> <p>.646 [16.41]</p> <p>±.031 [.79] TYP</p> <p>.812 [20.62] TYP</p> <p>.646 [16.41] TYP</p> <p>SERIES TRIP (4 TERM'S.)</p>	<p>RELAY TRIP</p> <p>ANSI: LINE, LOAD, RELAY, RELAY</p> <p>IEC: RELAY (RELAIS), LINE (NETZ) (3), LOAD (LAST), RELAY</p>		FG	0	<p>DUAL COIL: SERIES TRIP CURRENT COIL, RELAY TRIP VOLTAGE COIL</p> <p>ANSI: LINE, LOAD, RELAY, RELAY, VOLTAGE COIL</p> <p>IEC: LINE (NETZ), LOAD (LAST), RELAY, RELAY, VOLTAGE COIL</p>		K	0

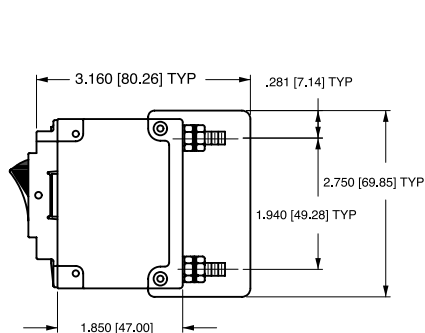

BARRIER FOR UL-RECOGNIZED MULTI-POLE BREAKERS

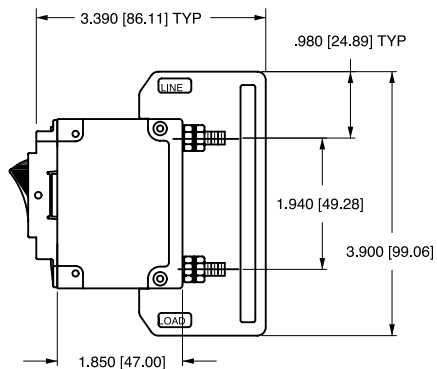

BARRIER FOR UL-489 LISTED MULTI-POLE BREAKERS

Notes:

- 1 All dimensions are in inches [millimeters].
- 2 Tolerance  $\pm 0.020$  [.51] unless otherwise specified.
- 3 Schematic shown represents current trip circuit.

## Dimensional Specifications: in. [mm]

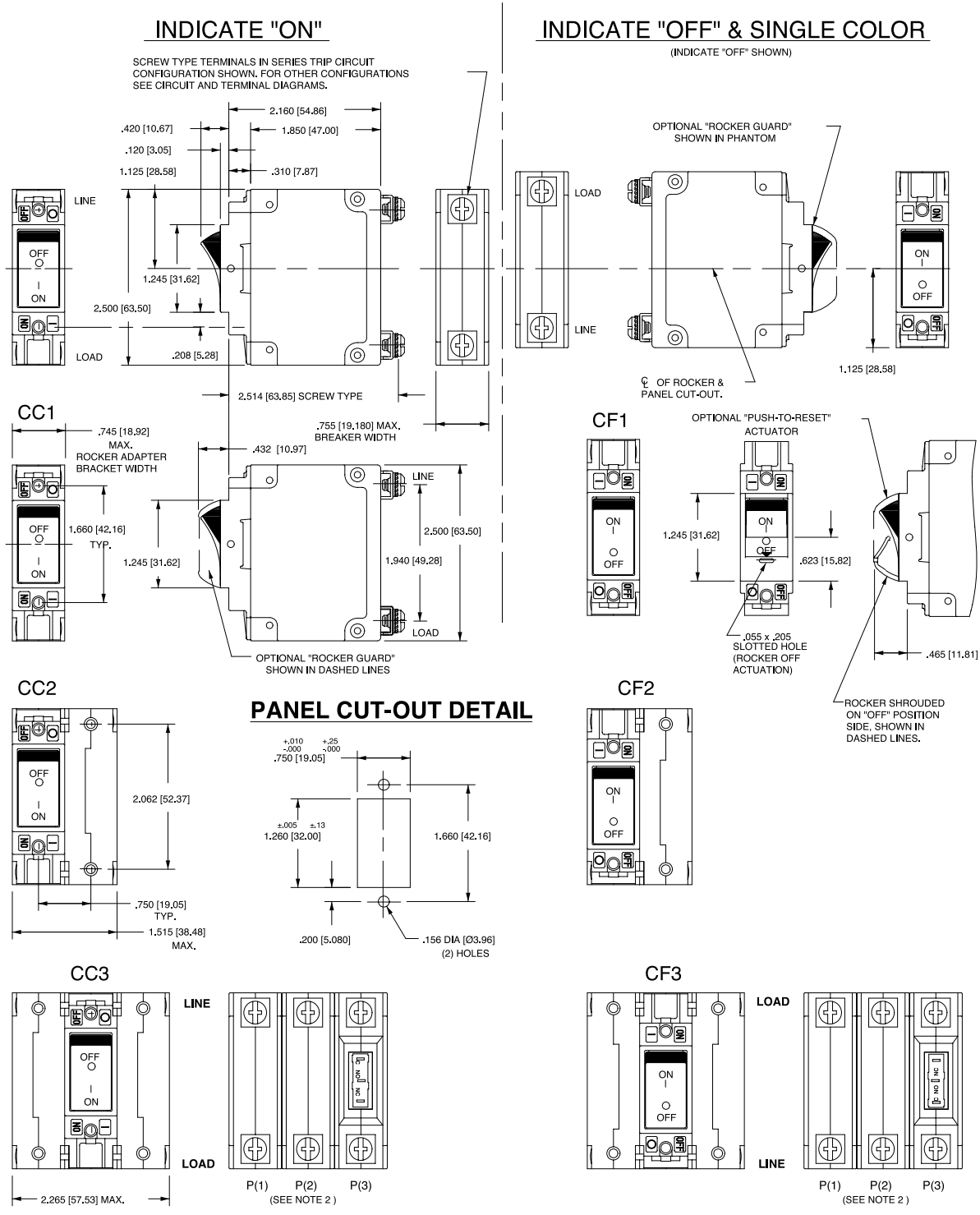

REAR VIEW OF INDICATE "ON" SERIES TRIP W/ AUX SWITCH CIRCUIT CONFIGURATION.

REAR VIEW OF INDICATE "OFF" SERIES TRIP W/ AUX SWITCH CIRCUIT CONFIGURATION.

- Notes:
- 1 Dimensions apply to all variations shown. Notice that circuit breaker line and load terminal orientation on indicate OFF is opposite of indicate ON.
  - 2 For pole orientation with horizontal legend, rotate front view clockwise 90°.
  - 3 All dimensions are in inches [millimeters].
  - 4 Tolerance  $\pm 0.020$  [.51] unless otherwise specified.

## Dimensional Specifications: in. [mm]

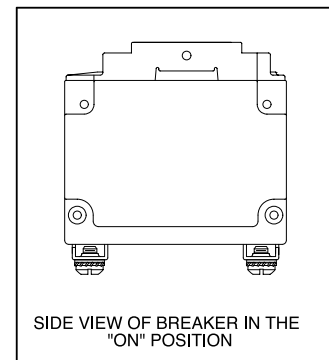
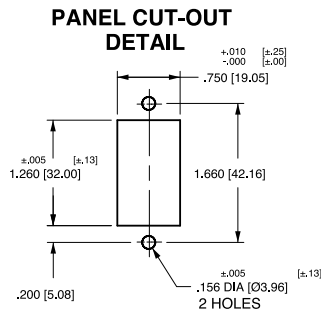
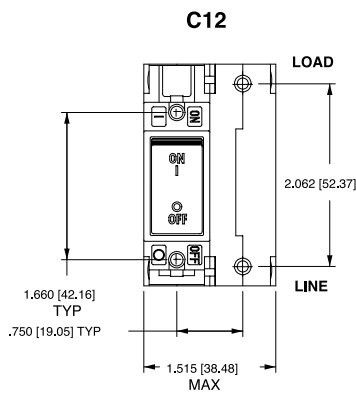
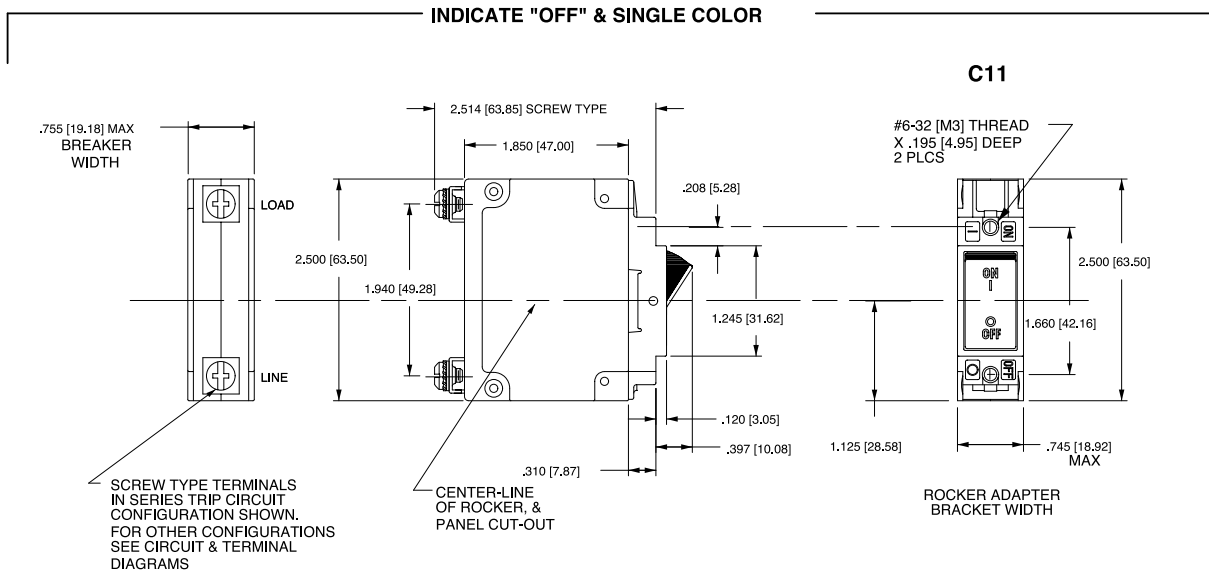

### PUSH-TO-RESET ACTUATOR

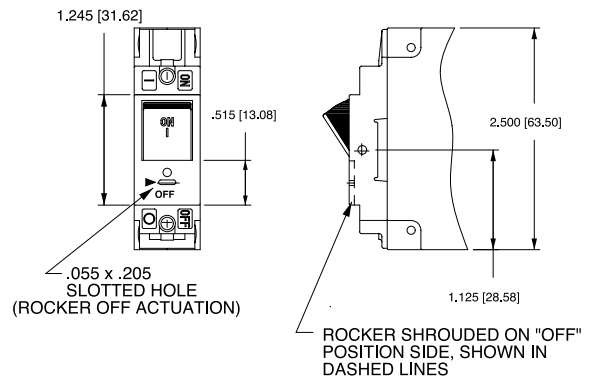

### ACTUATOR SIDE VIEW (SURFACE CONTOURS)

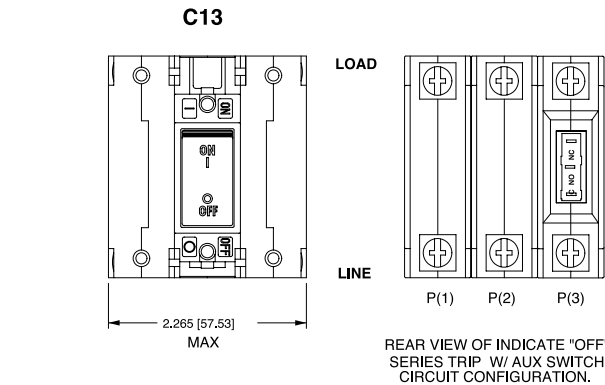
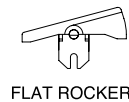

- Notes:
- 1 For pole orientation with horizontal legend, rotate front view clockwise 90°.
  - 2 All dimensions are in inches [millimeters].
  - 3 Tolerance ±.020 [.51] unless otherwise specified.

# E-Series

## CIRCUIT BREAKER

The E-Series hydraulic-magnetic circuit breaker is ideally suited for higher current and voltage applications. It is UL listed and CSA certified for branch circuit protection, which does not require a fuse back up. It is also UL recognized and CSA certified as a supplementary protector and as a manual motor controller.

Its physical features include front and back mounting, screw and stud terminals and heavy duty box wire connectors for solid wire or a pressure plate connector for standard wire. The E-series is available with handle actuators and can be configured as .1-125 amps, up to 600VAC or 125VDC, with choice of time delays, actuator colors and 1 to 6 poles configuration. Additionally, a Power Selector device is also available.



### Product Highlights:

- ♦ UL listed and CSA certified
- ♦ Certified for circuit branch protection
- ♦ Recognized as a supplementary protector and as a manual motor controller
- ♦ Optional power selector device

### Electrical

Maximum Voltage 600VAC 50/60 Hz, 125VDC (See Table A)

Current Ratings Standard current coils: 0.100, 0.250, 0.500, 1.00, 2.50, 5.00, 7.50, 10.0, 15.0, 20.0, 25.0, 30.0, 50.0, 60.0, 70.0 & 100 Amp.

Auxiliary Switch Rating SPDT; 10.1A 250VAC, 1.0A 65VDC; 0.5A 80VDC, 0.1A 125VAC (with gold contacts).

Insulation Resistance Minimum of 100 Megohms at 500 VDC.

Dielectric Strength UL, CSA: 2200 V 50/60 Hz for one minute between all electrically isolated terminals. E-Series Circuit Breakers comply with the 8mm spacing and 3750V 50/60 Hz dielectric requirements from hazardous voltage to operator accessible surfaces, between adjacent poles and from main circuits to auxiliary circuits per Publications EN 60950 and VDE 0805.

Resistance, Impedance Values from Line to Load Terminal - based on Series Trip Circuit Breaker.

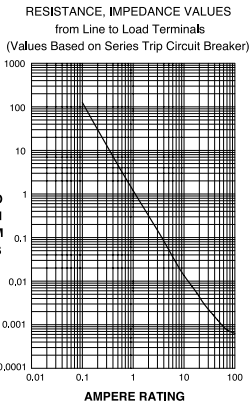

CURRENT (AMPS)	TOLERANCE (%)
0.10 - 5.0	± 15
5.1 - 20.0	± 25
20.1 - 50.0	± 35

### Pulse Tolerance Curves

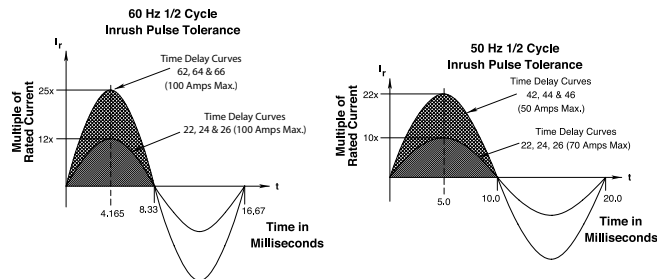

### Mechanical

Endurance 10,000 ON-OFF operations @ 6 per minute; with rated Current and Voltage.

Trip Free All E-Series Circuit Breakers will trip on overload, even when Handle is forcibly held in the ON position.

Trip Indication The operating Handle moves positively to the OFF position when an overload causes the breaker to trip.

### Physical

Number of Poles 1 - 6

Mounting A 3" minimum spacing must be provided between the circuit breaker arc venting area on back connected E-Series circuit breakers and grounded obstructions. E-Series circuit breakers must be mounted on a vertical surface.

Connectors, Box Type Front connected E-Series circuit breakers are supplied with box type pressure connectors that accept copper or aluminum conductors as follows: 1/0-14 Copper, 1/0-12 Aluminum. Series and Switch Only, (with or without auxiliary switch). Shunt with current coils.

Internal Circuit Configuration

Weight Approximately 252 grams/pole (Approximately 9 ounces/pole)

Standard Colors Housing-Black; Actuator - See Ordering Scheme.

### Environmental

Designed in accordance with requirements of specification MIL PRF-55629 & MIL-STD-202G as follows:

Shock Withstands 100 Gs, 6ms, sawtooth while carrying rated current per Method 213, Test Condition "I".

Vibration Withstands 0.060" excursion from 10-55 Hz, and 10 Gs 55-500 Hz, at rated current per Method 204C, Test Condition A.

Moisture Resistance Method 106D, i.e., ten 24-hour cycles @ +25°C to +65°C, 80-98% RH.

Salt Spray Method 101, Condition A (90-95% RH @ 5% NaCl Solution, 96 hrs).

Thermal Shock Method 107D, Condition A (Five cycles @ -55°C to +25°C to +85°C to +25°C).

Operating Temperature -40° C to +85° C

\*Manufacturer reserves the right to change product specification without prior notice.

Electrical Tables

Table A: Lists UL Listed (489) & CSA Certified (C22.2 No. 5) configurations & performance capabilities as a Molded Case Circuit Breaker.

E SERIES TABLE A : UL489 LISTED BRANCH CIRCUIT BREAKERS						
CIRCUIT CONFIGURATION	VOLTAGE			CURRENT RATING	INTERRUPTING CAPACITY (AMPS)	HIGH INTERRUPTING CAPACITY (AMPS)
	MAX. RATING	FREQUENCY	PHASE	FULL LOAD AMPS	WITHOUT BACKUP FUSE	
SERIES	80	DC	---	0.10 - 100	5,000	50,000
	125	DC	---	0.10 - 100	5,000	10,000
	125	DC	---	0.10 - 125	10,000	---
	120	50 / 60	1	0.10 - 125	10,000	---
	240	50 / 60	1	0.10 - 30	5,000	10,000
	240	50 / 60	1	31 - 100	5,000	---
	120 / 240	50 / 60	1	0.10 - 30	5,000	10,000
	120 / 240	50 / 60	1	31 - 100	5,000	---
	120 / 240	50 / 60	1	101 - 125	10,000	---
	240	50 / 60	3	0.10 - 100	5,000	---

Table B: Lists UL Recognized & CSA Accepted configurations & performance capabilities as a Component Supplementary Protector.

E-SERIES TABLE B: COMPONENT SUPPLEMENTARY PROTECTORS									
CIRCUIT CONFIGURATION	VOLTAGE			CURRENT RATING		SHORT CIRCUIT CAPACITY (AMPS)		APPLICATION CODES	
	MAX. RATING	FREQUENCY	PHASE	FULL LOAD AMPS	GENERAL PURPOSE AMPS	UL/CSA		UL	CSA
						WITH BACKUP FUSE <sup>3</sup>	WITHOUT BACKUP FUSE		
SERIES & SHUNT	125	DC	---	0.02 - 100	---	---	5,000	TC1,2, OL1, U1	TC1,2, OL1, U1
	125	DC	---	---	101 - 120	---	5,000	TC1,2, OL0, U1	TC1,2, OL0, U1
	150	DC	---	---	0.02 - 125	---	5,000	TC1, OL0, U3	TC1, OL0, U3
	160	DC	---	0.02 - 100	---	---	5,000	TC1,2, OL1, U1	TC1,2, OL1, U1
	150 / 300	DC	---	0.02 - 100	---	---	5,000	TC1,2, OL1, U1	TC1,2, OL1, U1
	120 / 240	50 / 60	1	---	0.02 - 100	---	5,000	TC1,2, OL0, U1	TC1,2, OL0, U1
	240	50 / 60	1	0.02 - 100	---	---	5,000	TC1,2, OL1, U1	TC1,2, OL1, U1
	250	50 / 60	1	0.02 - 100	---	10,000	---	TC1,2, OL1, C1	TC1,2, OL1, C1
	277	50 / 60	1	0.02 - 100	---	---	5,000	TC1,2, OL1, U1	TC1,2, OL1, U1
						10,000	---	TC1,2, OL1, C1	TC1,2, OL1, C1
	480	50 / 60	1 & 3	0.02 - 100	---	10,000	---	TC1,2, OL1, C1	TC1,2, OL1, C1
	480 <sup>1</sup>	50 / 60	1 & 3	0.02 - 50	---	10,000	---	TC1,2, OL1, C1	TC1,2, OL1, C1
600	50 / 60	1 & 3	0.02 - 100	---	10,000	---	TC1,2, OL1, C1	TC1,2, OL1, C1	
600 <sup>2</sup>	DC	---	---	0.02 - 125	---	5,000	TC1, OL0, U3	TC1, OL0, U3	
SWITCH ONLY	125	DC	---	0.02 - 120					
	160	DC	---	0.02 - 100					
	240	50 / 60	1	0.02 - 100					
	277	50 / 60	1	0.02 - 100					
	480	50 / 60	1 & 3	0.02 - 100					
	600	50 / 60	1 & 3	0.02 - 100					

Notes:  
 1 Per pole opposite polarity rating - Delta Configuration.  
 2 4 Poles connected in series  
 3 Requires branch circuit backup with a UL Listed Type K5 or RK5 fuse rated 15A minimum and no more than 4 times full load amp rating and not to exceed 225A.



## Electrical Tables

**Table C:** Lists UL Recognized, CSA Accepted and VDE Certified configurations and performance capabilities as a Component Supplementary Protector.

E -SERIES TABLE C: COMPONENT SUPPLEMENTARY PROTECTORS WITH VDE										
CIRCUIT CONFIGURATION	VOLTAGE			CURRENT RATING FULL LOAD AMPS	SHORT CIRCUIT CAPACITY (AMPS)			APPLICATION CODES		CONSTRUCTION NOTES
	MAX. RATING	FREQUENCY	PHASE		UL/CSA		VDE (Icn)	UL	CSA	
				WITH BACKUP FUSE <sup>1</sup>	WITHOUT BACKUP FUSE	WITHOUT BACKUP FUSE				
SERIES & SHUNT	125	DC	---	0.1 - 100	---	5,000	5,000	TC1,2, OL1, U1	TC1,2, OL1, U1	1 or 2 Poles
	240	50 / 60	1 & 3	0.1 - 100	---	5,000	5,000	TC1,2, OL1, U1	TC1,2, OL1, U1	1 - 5 Poles. Up to 4 Current Poles, 1 Voltage Pole
SHUNT	415	50 / 60	1 & 3	0.1 - 100	10,000	---	4,000	TC1,2, OL1, C1	TC1,2, OL1, C1	2 - 5 Poles. Up to 4 Current Poles, 1 Voltage Pole
SWITCH ONLY	125	DC	---	0.1 - 125						
	240	50 / 60	1 & 3	0.1 - 100						
	415	50 / 60	1 & 3	0.1 - 100						

**Notes:**

<sup>1</sup> Requires branch circuit backup with a UL LISTED Type K5 or RK5 fuse rated 15A minimum and no more than 4 times full load amp rating and not to exceed 225 amps.

**Table D:** Lists UL Recognized, CSA Accepted configurations and performance capabilities as Protectors, Supplementary for Marine Electrical and Fuel Systems (Guide PEQZ2, File E75596). Ignition Protected per UL 1500. UL Classified Small Craft Electrical Devices, Marine in accordance with ISO 8846 (Guide UZMK, File MQ1515) as Marine Supplementary Protectors.

E SERIES TABLE D : UL1500 (Marine Ignition Protection)							
CIRCUIT CONFIGURATION	VOLTAGE			CURRENT RATING FULL LOAD AMPS	SHORT CIRCUIT CAPACITY (AMPS) WITHOUT BACKUP FUSE	APPLICATION CODES	
	MAX. RATING	FREQUENCY	PHASE			UL	CSA
				SERIES	65		
125	50 / 60	1	0.02 - 100		1,500	TC1,2,OL1,U1	TC1,2,OL1,U1
250	50 / 60	1	0.02 - 100		1,500	TC1,2,OL1,U1	TC1,2,OL1,U1

## Agency Certifications

### UL Recognized

UL Standard 1077



Component Recognition Program as Protectors, Supplementary (Guide QVNU2, File E75596)

### CSA Accepted



Component Supplementary Protector (Class 3215 30, File 047848 0 000)  
CSA Standard C22.2 No. 235

Component Recognition Program as Manual Motor Controls (Guide NLRV2, File E135367)

### CSA Certified



Circuit Breaker Molded Case (Class 1432 01, File 093910),  
CSA Standard C22.2 No. 5.1 - M

UL Standard 1500



Protectors, Supplementary for Marine Electrical & Fuel Systems (Guide PEQZ2, File E75596)  
Ignition Protection

### TUV Certified



EN60934 under License No. R72031056

### UL Listed

UL Standard 489



Circuit Breakers, Molded Case (Guide DIVQ, File E129899)

### VDE Certified



EN60934, VDE 0642 under File No. 10537



- 1 Series
- 2 Actuator
- 3 Poles
- 4 Circuit
- 5 Auxiliary Switch
- 6 Frequency & Delay
- 7 Current Rating
- 8 Terminal
- 9 Actuator Color
- 10 Mounting/Barriers
- 11 Maximum Application Rating
- 12 Agency Approval

**1 SERIES**  
E

**2 ACTUATOR**  
A Handle, one per pole

**3 POLES**<sup>1</sup>

1 One	3 Three	5 Five
2 Two	4 Four	6 Six

**4 CIRCUIT**<sup>2</sup>

A <sup>3</sup> Switch Only (no coil)	E Shunt Trip (voltage)
B Series Trip (current)	F Relay Trip (current)
C Series Trip (voltage)	G Relay Trip (voltage)
D Shunt Trip (current)	

**5 AUXILIARY SWITCH**<sup>4</sup>

0 without Auxiliary Switch	6 S.P.S.T. 0.110 Q.C. Terminals
2 S.P.D.T. 0.110 Q.C. Terminals	7 S.P.S.T. 0.110 Q.C. Terminals (Gold Contacts)
3 S.P.D.T. 0.139 Solder Lug	
4 S.P.D.T. 0.110 Q.C. Terminals (Gold Contacts)	8 S.P.S.T. 0.187 Q.C. Terminals
	9 S.P.D.T. 0.187 Q.C. Terminals

**6 FREQUENCY & DELAY**

03 <sup>3</sup> DC 50/60Hz, Switch Only	34 DC, 50/60Hz Medium
10 <sup>5</sup> DC Instantaneous	36 DC, 50/60Hz Long
12 DC Short	62 50/60Hz Short, Hi-Inrush
14 DC Medium	64 50/60Hz Medium, Hi-Inrush
16 DC Long	66 50/60Hz Long, Hi-Inrush
20 <sup>5</sup> 50/60Hz Instantaneous	72 DC, Short, Hi-Inrush
22 50/60Hz Short	74 DC, Medium, Hi-Inrush
24 50/60Hz Medium	76 DC, Long, Hi-Inrush
26 50/60Hz Long	92 <sup>6</sup> DC, 50/60Hz Short, Hi-Inrush
30 DC, 50/60Hz Instantaneous	94 <sup>6</sup> DC, 50/60Hz Medium, Hi-Inrush
32 DC, 50/60Hz Short	96 <sup>6</sup> DC, 50/60Hz Long, Hi-Inrush

**7 CURRENT RATING (AMPERES)**<sup>7</sup>

CODE	AMPERES				
020	0.020	235	0.350	430	3.000
025	0.025	240	0.400	435	3.500
030	0.030	245	0.450	440	4.000
035	0.035	250	0.500	445	4.500
040	0.040	255	0.550	450	5.000
045	0.045	260	0.600	455	5.500
050	0.050	265	0.650	460	6.000
055	0.055	270	0.700	465	6.500
060	0.060	275	0.750	470	7.000
065	0.065	280	0.800	475	7.500
070	0.070	285	0.850	480	8.000
075	0.075	290	0.900	485	8.500
080	0.080	295	0.950	490	9.000
085	0.085	300	1.000	495	9.500
090	0.090	310	1.100	505	10.500
095	0.095	320	1.200	515	11.500
100	0.100	330	1.300	525	12.500
110	0.110	345	1.450	540	14.000
120	0.120	360	1.600	560	16.000
130	0.130	375	1.750	580	18.000
140	0.140	390	1.900	600	20.000
150	0.150	405	2.050	620	22.000
160	0.160	420	2.200	640	24.000
170	0.170	435	2.350	660	26.000
180	0.180	450	2.500	680	28.000
190	0.190	465	2.650	700	30.000
200	0.200	480	2.800	720	32.000
225	0.225	525	3.150	770	35.000
250	0.250	575	3.500	830	38.000
300	0.300	650	4.000	912 <sup>8</sup>	125.000

**OR VOLTAGE COIL (MIN. TRIP RATING, VOLTS)**<sup>5</sup>

A06 6 DC, 5 DC	A65 65 DC, 55 DC	J48 48 AC, 40 AC
A12 12 DC, 10 DC	B25 125 DC, 100 DC	J65 65 AC, 55 AC
A18 18 DC, 15 DC	J06 6 AC, 5 AC	K20 120 AC, 65 AC
A24 24 DC, 20 DC	J12 12 AC, 10 AC	L40 240 AC, 130 AC
A32 32 DC, 25 DC	J18 18 AC, 15 AC	
A48 48 DC, 40 DC	J24 24 AC, 20 AC	

**Notes:**

- 1 VDE approval on 1-5 poles only. Standard multi-pole units identical poles except when specifying auxiliary switch - (see Note 4). For mixed ratings, consult factory.
- 2 Switch Only & Series Trip construction available with either front or back connected terminals. Shunt construction available with back connected terminals, (Terminal Codes 1 & 2) only. Circuit Codes B,C & D are VDE approved.
- 3 Switch Only construction: 30 amps or less select Current Rating Code 630; 31-70 amps, select Current Rating code 670; 71-100 amps, select Current Rating Code 810; 101-125 amps Select Current Rating Code 912. Switch Only is VDE approved only if tied to a protected pole.

**8 TERMINAL**<sup>12</sup>  
**BACK CONNECTED (FRONT MOUNTED ONLY)**

	MAX. RATING
1 <sup>9</sup> 10-32 Stud (All Terminals)	50 A
2 <sup>9</sup> 1/4-20 Stud (All Terminals)	120 A
A <sup>9</sup> M5 Stud (Line & Load)	50 A
B <sup>9</sup> M6 Stud (Line & Load)	100 A

**FRONT CONNECTED (BACK MOUNTED ONLY)**

	MAX. RATING
3 <sup>10</sup> Box Wire Connector (Line & Load)	100 A
C <sup>11</sup> Box Wire Connector with Pressure Plate (Line & Load)	100 A
4 10-32 Screw (Line & Load)	50 A
D M5 Screw (Line & Load)	50 A
5 10-32 "Bus-Type" Screw (Line), 10-32 Screw (Load)	50 A
E M5 "Bus-Type" Screw (Line), 10-32 Screw (Load)	50 A
6 <sup>10</sup> 10-32 "Bus-Type" Screw (Line), Box Wire Connector (Load)	100 A
F <sup>11</sup> 10-32 "Bus-Type" Screw (Line), Box Wire Connector with Pressure Plate (Load)	100 A
7 1/4-20 Screw (Line & Load)	100 A
G M6 Screw (Line & Load)	100 A
8 1/4-20 "Bus-Type" Screw (Line), 1/4-20 Screw (Load)	100 A
H M6 "Bus-Type" Screw (Line), M6 Screw (Load)	100 A
9 <sup>10</sup> 1/4-20 "Bus-Type" Screw (Line), Box Wire Connector (Load)	100 A
J <sup>11</sup> 1/4-20 "Bus-Type" Screw (Line), Box Wire Connector with Pressure Plate (Load)	100 A

**9 ACTUATOR COLOR & LEGEND**<sup>13</sup>

Actuator Color	I-O	ON-OFF	Dual	Legend Color
White	A	B	1	Black
Black	C	D	2	White
Red	F	G	3	White
Green	H	J	4	White
Blue	K	L	5	White
Yellow	M	N	6	Black
Gray	P	Q	7	Black
Orange	R	S	8	Black

**10 MOUNTING / BARRIERS**  
**BACK CONNECTED (FRONT MOUNTED ONLY)**

**Mounting Inserts**

A 6-32
B ISO M3

**FRONT CONNECTED (BACK MOUNTED ONLY)**<sup>14</sup>

Back Mounting Foot Type	Front Mounting Inserts (Optional Use)
C Short	6-32
D Short	ISO M3
E Long	6-32
F Long	ISO M3

**11 MAXIMUM APPLICATION RATING**<sup>15</sup>

A 65 VDC, 120 A	G <sup>16</sup> 600 VAC, 100 A
B 125 VDC, 120 A	H <sup>16</sup> 480 VAC, 100 A
C 120/240 VAC, 100 A	J <sup>16</sup> 415 VAC, 100 A
D 240 VAC, 100 A	L <sup>16</sup> 160 VDC, 100 A
E <sup>16</sup> 277/480 VAC, 100 A	T 125 VDC/240 VAC, 100 A
F 277 VAC, 100 A	W <sup>16</sup> 125 VDC/415 VAC, 100 A

**12 AGENCY APPROVAL**

B UL 1077 / UL508 Recognized & CSA Accepted  
D UL 1077 Recognized, CSA Accepted, & VDE Certified

- 4 Auxiliary Switch available on Switch Only and Series Trip units. On multi-pole units, only one auxiliary switch is normally supplied mounted in the extreme right pole. Back mounted units require special mounting provisions when auxiliary switch is specified. VDE approval on Auxiliary Switch Codes 0,2,3 & 4 only.
- 5 Voltage Trip Coils are not rated for continuous duty. Available only with Frequency & Delay Codes 10 & 20. Series Trip construction with a voltage coil s VDE approved only if tied to a protected pole.
- 6 Frequency & Delay Codes 92,94 & 96 are not VDE Certified.
- 7 Current Coil Ratings 0.100 - 100 amps are VDE Certified.
- 8 125 A rating (Code 912) available as a Switch Only (Circuit Code A), rated 125 VDC (Code B).
- 9 An Anti-Flash Over Barrier is supplied between poles on multi-pole units with 10-32 (Terminal Code 1), 1/4-20 (Code 2), M5 (Code A), and M6 (Code B) terminals per UL requirement.
- 10 Box Wire Connector will accept #14 through 10 AWG. copper wire or #12 through 10 AWG. aluminum wire.
- 11 Box Wire Connector with Pressure Plate for stranded wire, consult factory for details.
- 12 Terminal Codes A,B,D,E,G & H are not VDE Certified.
- 13 VDE approvals require Dual (I-O, ON-OFF) or I-O markings on all handles.
- 14 Back Mounted breakers can also be front mounted by utilizing the proper front panel mounting inserts normally supplied. However, terminal connections must be made prior to mounting.
- 15 Application ratings B,D,J,T & W are available with VDE.
- 16 415, 480 & 600 VAC ratings require 3 or 4 pole break 3Ø and 2 pole break 1Ø.

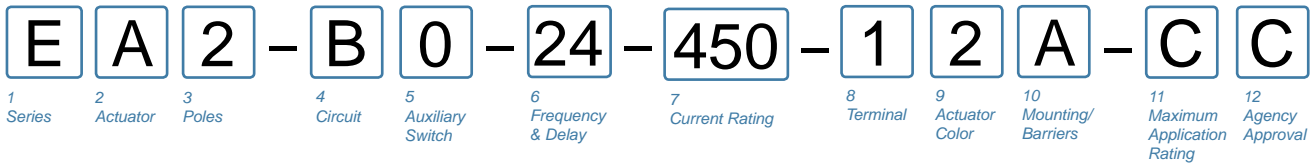

**1 SERIES**  
E

**2 ACTUATOR**  
A Handle, one per pole

**3 POLES**<sup>1</sup>

1	One	3	Three	5	Five
2	Two	4	Four	6	Six

**4 CIRCUIT**<sup>2</sup>

B<sup>3</sup> Series Trip (current)  
C<sup>3</sup> Series Trip (voltage)

**5 AUXILIARY SWITCH**<sup>4</sup>

0	without Auxiliary Switch	6	S.P.S.T. 0.110 Q.C. Terminals
2	S.P.D.T. 0.110 Q.C. Terminals	7	S.P.S.T. 0.110 Q.C. Terminals (Gold Contacts)
3	S.P.D.T. 0.139 Solder Lug	8	S.P.S.T. 0.187 Q.C. Terminals
4	S.P.D.T. 0.110 Q.C. Terminals (Gold Contacts)	9	S.P.D.T. 0.187 Q.C. Terminals

**6 FREQUENCY & DELAY**

10	DC Instantaneous	62	50/60Hz Short, Hi-Inrush
12	DC Short	64	50/60Hz Medium, Hi-Inrush
14	DC Medium	66	50/60Hz Long, Hi-Inrush
16	DC Long	72	DC, Short, Hi-Inrush
20	50/60Hz Instantaneous	74	DC, Medium, Hi-Inrush
22	50/60Hz Short	76	DC, Long, Hi-Inrush
24	50/60Hz Medium		
26	50/60Hz Long		

**7 CURRENT RATING (AMPERES)**<sup>7</sup>

CODE	AMPERES				
020	0.020	235	0.350	430	3.000
025	0.025	240	0.400	435	3.500
030	0.030	245	0.450	440	4.000
035	0.035	250	0.500	445	4.500
040	0.040	255	0.550	450	5.000
045	0.045	260	0.600	455	5.500
050	0.050	265	0.650	460	6.000
055	0.055	270	0.700	465	6.500
060	0.060	275	0.750	470	7.000
065	0.065	280	0.800	475	7.500
070	0.070	285	0.850	480	8.000
075	0.075	290	0.900	485	8.500
080	0.080	295	0.950	490	9.000
085	0.085	410	1.000	495	9.500
090	0.090	512	1.250	610	10.000
090	0.095	415	1.500	710	10.500
100	0.100	517	1.750	611	11.000
110	0.150	420	2.000	711	11.500
120	0.200	522	2.250	612	12.000
130	0.250	425	2.500	712	12.500
140	0.300	527	2.750	613	13.000
150					
160					
170					
180					
190					
200					
210					
220					
230					
240					
250					
260					
270					
280					
290					
300					
310					
320					
330					
340					
350					
360					
370					
380					
390					
400					
410					
420					
430					
440					
450					
460					
470					
480					
490					
500					
510					
520					
530					
540					
550					
560					
570					
580					
590					
600					
610					
620					
630					
640					
650					
660					
670					
680					
690					
700					
710					
720					
730					
740					
750					
760					
770					
780					
790					
800					
810					
820					
830					
840					
850					
860					
870					
880					
890					
900					
910					
920					
930					
940					
950					
960					
970					
980					
990					
1000					

**OR VOLTAGE COIL (MIN. TRIP RATING, VOLTS)**<sup>5</sup>

A06	6 DC, 5 DC	A65	65 DC, 55 DC	J48	48 AC, 40 AC
A12	12 DC, 10 DC	B25	125 DC, 100 DC	J65	65 AC, 55 AC
A18	18 DC, 15 DC	J06	6 AC, 5 AC	K20	120 AC, 65 AC
A24	24 DC, 20 DC	J12	12 AC, 10 AC	L40	240 AC, 130 AC
A32	32 DC, 25 DC	J18	18 AC, 15 AC		
A48	48 DC, 40 DC	J24	24 AC, 20 AC		

**8 TERMINAL**<sup>7</sup>

**BACK CONNECTED (FRONT MOUNTED ONLY)**

MAX. RATING
1 <sup>8</sup> 10-32 Stud (All Terminals) 50 A
2 <sup>8</sup> 1/4-20 Stud (All Terminals) 125 A

**FRONT CONNECTED (BACK MOUNTED ONLY)**

MAX. RATING
3 <sup>9</sup> Box Wire Connector (Line & Load) 100 A
C <sup>10</sup> Box Wire Connector with Pressure Plate (Line & Load) 100 A
4 10-32 Screw (Line & Load) 50 A
5 10-32 "Bus-Type" Screw (Line), 10-32 Screw (Load) 50 A
6 <sup>9</sup> 10-32 "Bus-Type" Screw (Line), Box Wire Connector (Load) 100 A
F <sup>10</sup> 10-32 "Bus-Type" Screw (Line), Box Wire Connector with Pressure Plate (Load) 100 A
7 1/4-20 Screw (Line & Load) 125 A
8 1/4-20 "Bus-Type" Screw (Line), 1/4-20 Screw (Load) 100 A
9 <sup>9</sup> 1/4-20 "Bus-Type" Screw (Line), Box Wire Connector (Load) 100 A
J <sup>10</sup> 1/4-20 "Bus-Type" Screw (Line), Box Wire Connector with Pressure Plate (Load) 100 A

**9 ACTUATOR COLOR & LEGEND**<sup>12</sup>

Actuator Color	ON-OFF	Dual	Legend Color
White	B	1	Black
Black	D	2	White
Red	G	3	White
Green	J	4	White
Blue	L	5	White
Yellow	N	6	Black
Gray	Q	7	Black
Orange	S	8	Black

**10 MOUNTING / BARRIERS**

**BACK CONNECTED (FRONT MOUNTED ONLY)**

**Mounting Inserts**

A	6-32
B	ISO M3

**FRONT CONNECTED (BACK MOUNTED ONLY)**<sup>11</sup>

Back Mounting Foot Type	Front Mounting Inserts (Optional Use)
C Short	6-32
D Short	ISO M3
E Long	6-32
F Long	ISO M3

**11 MAXIMUM APPLICATION RATING**<sup>15</sup>

1	120 VAC
B	125 VDC, 120 A
C <sup>13</sup>	120/240 VAC, 100 A
D	240 VAC, 100 A

**12 AGENCY APPROVAL**

C	UL 489 Listed & CSA Certified
F	UL 489 Listed, CSA Certified, & VDE Certified

- Notes:
- Standard multi-pole units identical poles except when specifying auxiliary switch - (see Note 4). For mixed ratings, consult factory. VDE Certification on 1-5 poles only.
  - Series Trip construction available with either front or back connected terminals.
  - Series Trip construction with a voltage coil is not available as a single pole unit and must be tied to a protected pole.
  - On multi-pole units, only one auxiliary switch is normally supplied mounted in the extreme right pole per Figure A. Back mounted units require special mounting provisions when auxiliary switch is specified. VDE Certification on auxiliary switch codes 0, 2, 3 & 4 only.
  - Voltage Trip Coils are not rated for continuous duty. Available only with Frequency & Delay Codes 10 & 20.
  - Frequency & Delay Codes 92, 94 & 96 are not VDE Certified.
  - Current Ratings under 0.100 amps are not VDE Certified.
  - An Anti-Flash Over Barrier is supplied between poles on multi-pole units with 10-32 Stud (Terminal Code 1) or 1/4-20 Stud (Code 2) terminals per UL requirement.
  - Box Wire Connector will accept #14 through 0 AWG. copper wire or #12 through 0 AWG. aluminum wire.
  - Box Wire Connector with Pressure Plate for stranded wire, consult factory for details.
  - Back Mounted breakers can also be front mounted by utilizing the proper front panel mounting inserts normally supplied. However, terminal connections must be made prior to mounting.
  - VDE Certification requires dual (I-O, ON-OFF) markings on all handles.
  - Not available with VDE Certification.

## Circuit & Terminal Diagrams: in. [mm]

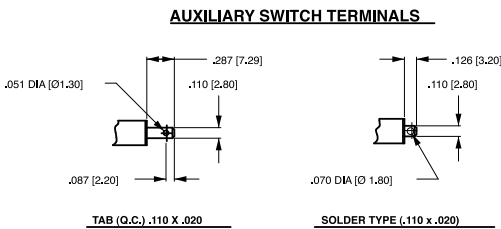
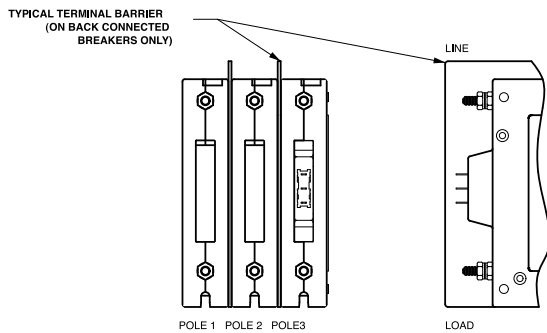
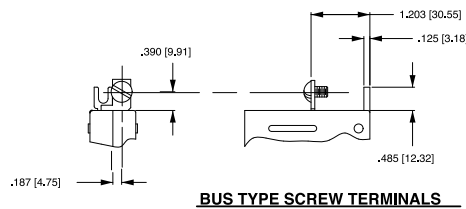
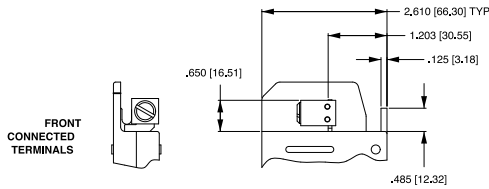
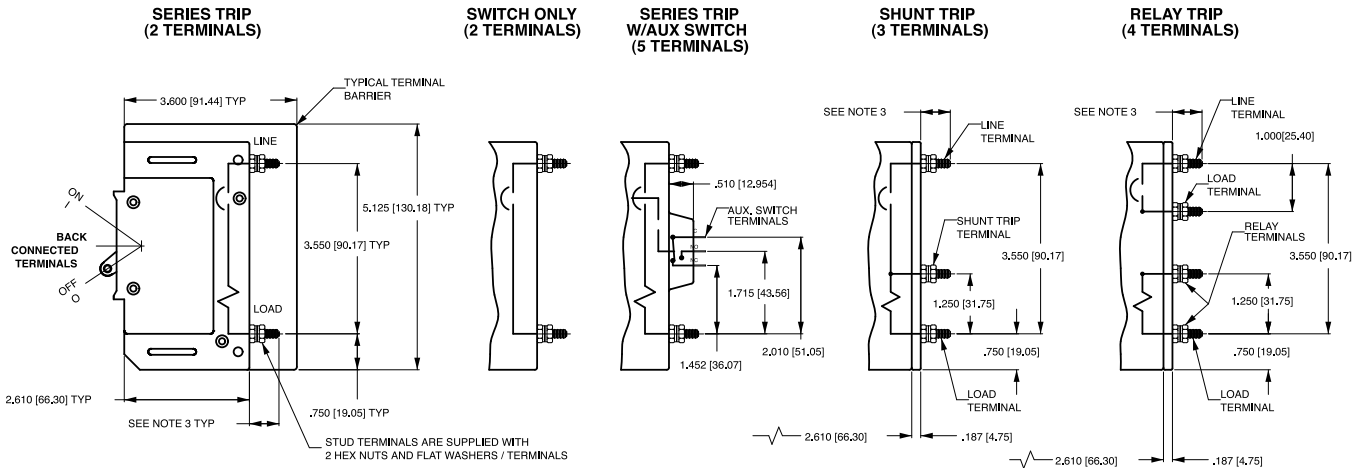

**MULTI-POLE IDENTIFICATION SCHEME**

TABLE A TIGHTENING TORQUE SPECIFICATIONS		
THREAD SIZE TERMINAL TYPE	WIRE SIZE	TORQUE
#6-32 (M3) HARDWARE	—	7-9 IN-LBS (0.8-1.0 N·M)
#10-32 THD TERMINAL SCREW	ALL	15-20 IN-LBS (1.7-2.3 N·M)
1/4-20 THD TERMINAL SCREW	ALL	30-35 IN-LBS (3.4-4.0 N·M)
#10-32 STUDS	ALL	15-20 IN-LBS (1.7-2.3 N·M)
1/4-20 STUDS	ALL	30-35 IN-LBS (3.4-4.0 N·M)
BOX WIRE CONNECTOR	14-10 AWG	35 IN-LBS (4.0 N·M)
	8 AWG	40 IN-LBS (4.5 N·M)
	6-4 AWG	45 IN-LBS (5.1 N·M)
	3-10 AWG	50 IN-LBS (5.7 N·M)

**Notes:**

- All dimensions are in inches [millimeters].
- Tolerance  $\pm 0.020$  [51] unless otherwise specified.
- 0-50 amps: 10-32 & M5 Studs .625 $\pm$ .062/15.88 $\pm$ 1.574 long.
- 51-120 amps: 1/4-20 & M6 Studs .750 $\pm$ .062/19.05 $\pm$ 1.574 long.

## Dimensional Specifications: in. [mm]

### MOUNTING INSERTS:

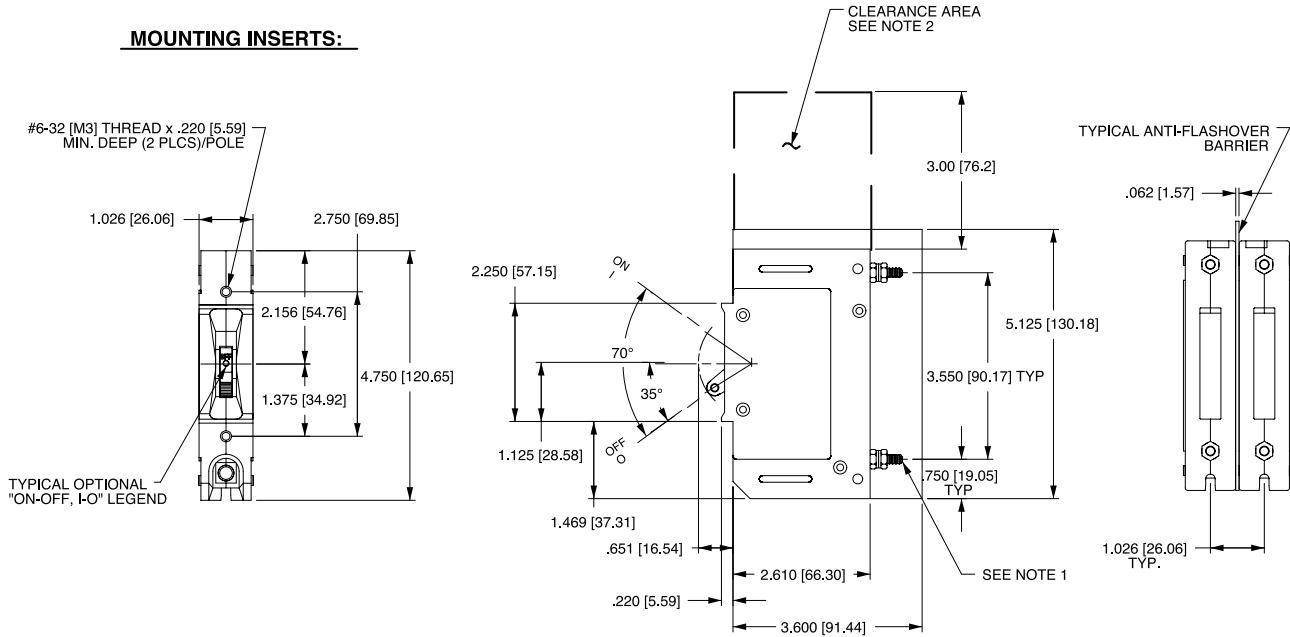

### PANEL CUTOUT DETAIL

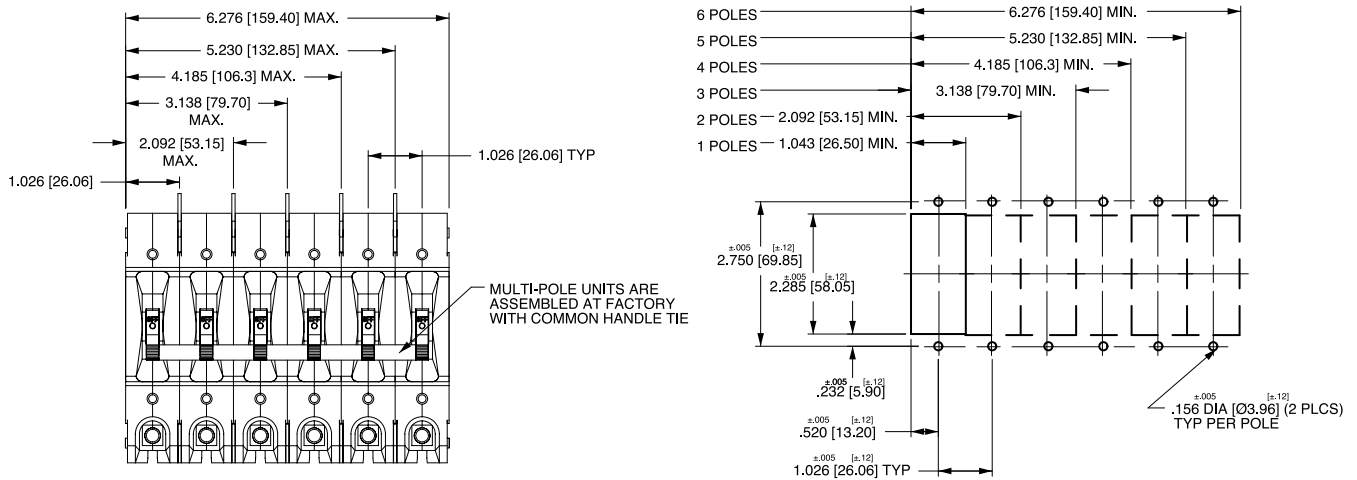

Notes:

- 1 1/4 -20 stud terminal in Series Trip circuit configuration shown.
- 2 A 3" min spacing must be provided between the circuit breaker arc venting area of back connected E-Series circuit breaker and grounded obstructions.
- 3 All dimensions are in inches [millimeters].
- 4 Tolerance ±.020 [5.1] unless otherwise specified.
- 5 Circuit breakers must be mounted on vertical surface.

## Dimensional Specifications: in. [mm]

### MOUNTING INSERTS:

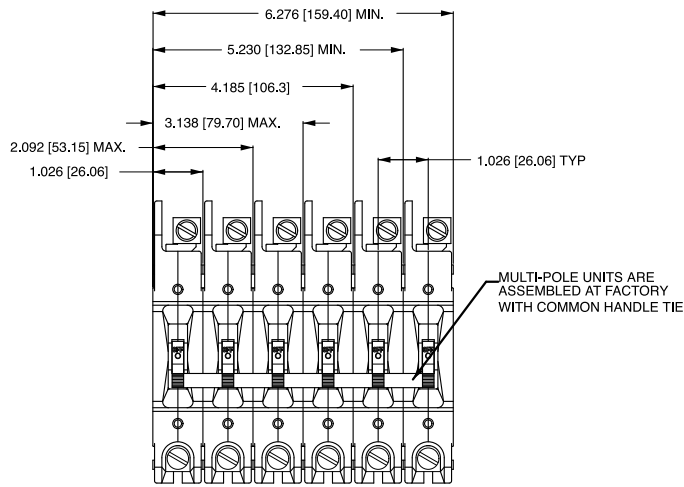
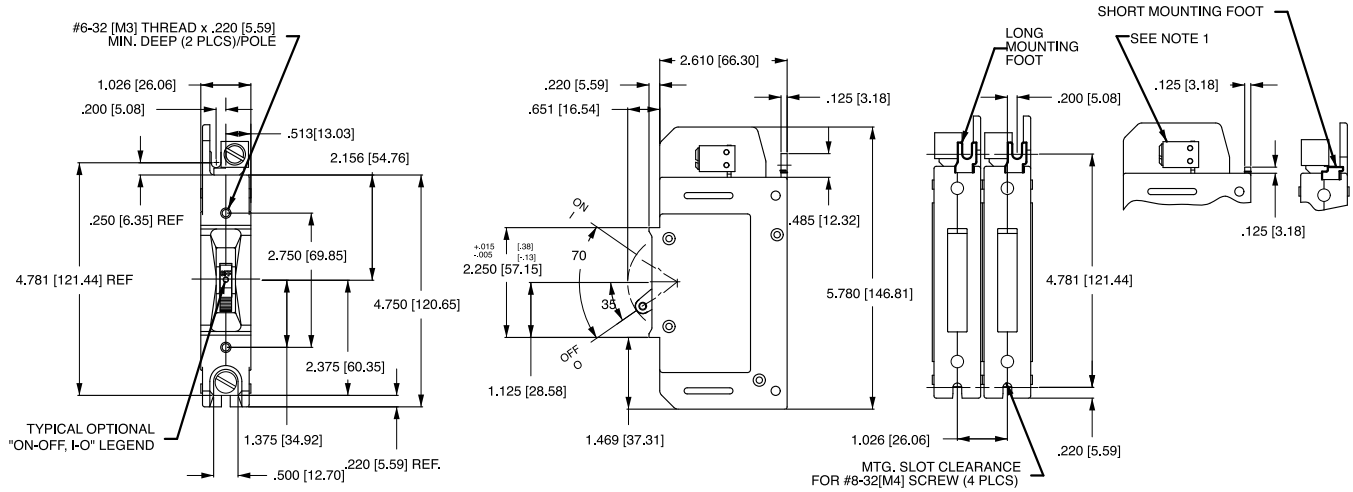

### PANEL CUTOUT DETAIL

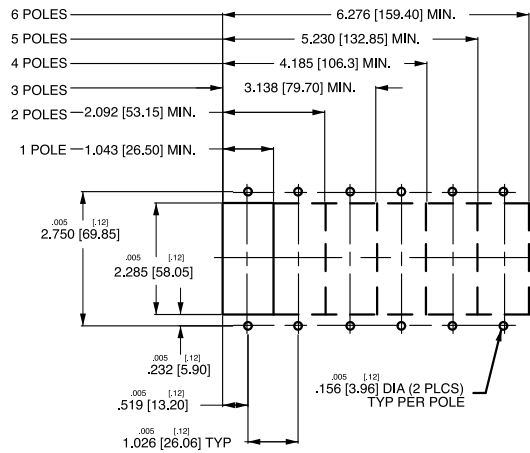

**Notes:**

- 1 All dimensions are in inches [millimeters].
- 2 Tolerance  $\pm .020$  [.51] unless otherwise specified.
- 3 Box wire connector terminal in Series Trip circuit configuration shown.
- 4 Circuit breakers must be mounted on vertical surface.

M, MS-SERIES TIME DELAY VALUES										
TRIP TIME SECONDS	PERCENT OF RATED CURRENT									
	Delay	100%	135%	150%	200%	400%	600%	800%	1000%	1200%
	10, 20, 30	No Trip	May Trip	.100 Max	.100 Max	.100 Max	.100 Max	.100 Max	.100 Max	.100 Max
12, 22, 32, 62, 72, 92	No Trip	.300 - 7.00	.200 - 5.00	.100 - 2.00	.030 - .500	.008 - .300	.006 - .150	.005 - .100	.005 - .100	.005 - .100
14, 24, 34, 64, 74, 94	No Trip	3.00 - 70.0	2.00 - 40.0	1.00 - 15.0	.100 - 4.00	.008 - 2.00	.006 - .800	.005 - .350	.005 - .160	.005 - .160

**Notes:**

- 1 Delay Curves 12,14, 22, 24, 32, 34, 62, 64, 72, 74, 92, 94: Breakers to hold 100% and must trip at 135% of rated current and greater within the time limit shown in this curve.
- 2 Delay Curves 10, 20, 30: Breakers to hold 100% and must trip at 150% of rated current and greater within the time limit shown in this curve.
- 3 All Curves: Curve data shown represents breaker response at ambient temperature of 77°F (25°C) with no preloading. Breakers are mounted in standard wall-mount position.
- 4 The minimum inrush pulse tolerance handling capability is 12 times the rated current on standard delays and 18 times the rated current on high inrush delays. These values are based on a 60 Hz 1/2 cycle, 8.33 ms pulse. High inrush delays should be specified for applications with high initial surge currents of short duration, such as switching power supplies, highly capacitive loads and transformer loads.

## Dual Rated AC/DC

### Instantaneous

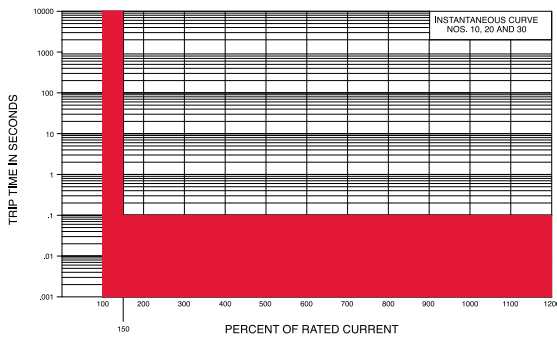

### Short

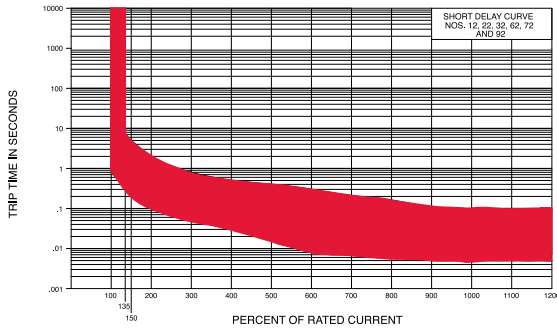

### Short D2

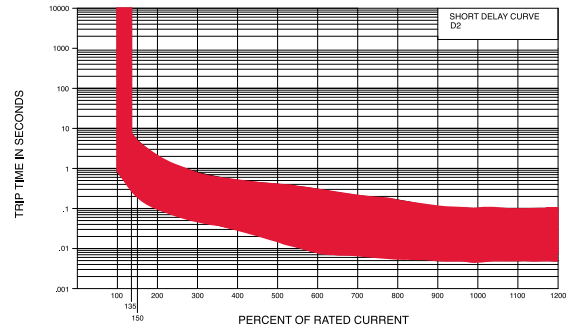

### Medium

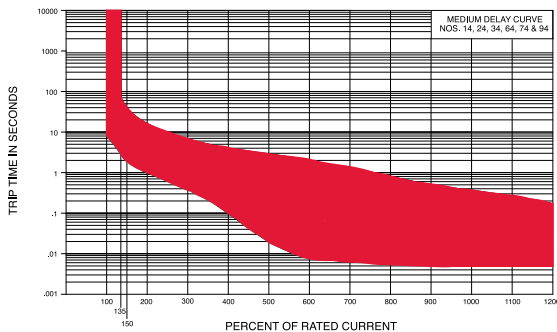

### Medium D4

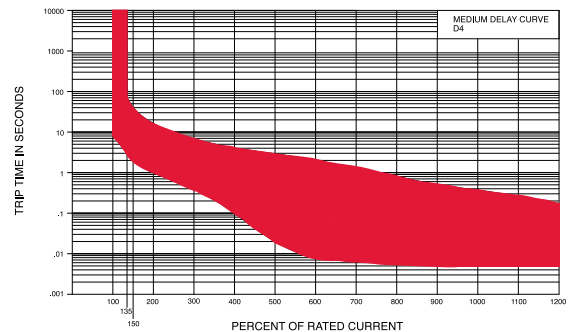

A, B, C, CX, D, G, H, L, N-SERIES TIME VALUES											
TRIP TIME (SECONDS)	PERCENT OF RATED CURRENT										
	DELAY	100%	125%	135%	150%	200%	400%	600%	800%	1000%	1200%
10	No Trip	May Trip	---	.032 MAX	.024 MAX	.020 MAX	.018 MAX	.016 MAX	.015 MAX	.013 MAX	
11	No Trip	.013 - .125	---	.010 - .070	.008 - .032	.006 - .020	.005 - .020	.004 - .020	.004 - .020	.004 - .020	
12	No Trip	.500 - 6.50	---	.300 - 3.00	.130 - 1.20	.031 - .220	.011 - .120	.004 - .090	.004 - .060	.004 - .040	
14	No Trip	2.00 - 60.0	---	1.20 - 40.0	.600 - 20.0	.150 - 3.00	.030 - 1.30	.004 - .600	.004 - .100	.004 - .100	
16	No Trip	45.0 - 345	---	20.0 - 150	9.00 - 60.0	1.40 - 11.4	.150 - 5.80	.009 - 3.70	.005 - 1.70	.005 - .500	
20	No Trip	May Trip	---	.040 MAX	.035 MAX	.030 MAX	.025 MAX	.020 MAX	.017 MAX	.015 MAX	
21	No Trip	.014 - .150	---	.011 - .095	.008 - .055	.006 - .035	.005 - .027	.005 - .021	.004 - .018	.004 - .017	
22	No Trip	.700 - 12.0	---	.350 - 4.00	.130 - 1.30	.027 - .220	.008 - .130	.004 - .090	.004 - .045	.004 - .040	
24	No Trip	10.0 - 160	---	6.00 - 60.0	2.20 - 20.0	.300 - 3.00	.050 - 1.30	.007 - .500	.005 - .060	.005 - .040	
26	No Trip	50.0 - 700	---	32.0 - 350	10.0 - 90.0	1.50 - 15.0	.500 - 7.00	.020 - 3.00	.005 - 2.00	.005 - 1.00	
32	No Trip	May Trip	.400 - 8.00	.300 - 4.00	.130 - 1.30	.027 - .220	.008 - .130	.004 - .090	.004 - .060	.004 - .040	
34	No Trip	May Trip	1.80 - 100	1.20 - 60.0	.600 - 20.0	.150 - 3.00	.030 - 1.30	.004 - .600	.004 - .110	.004 - .100	
36	No Trip	May Trip	35.0 - 520	20.0 - 350	9.00 - 90.0	1.40 - 15.0	.150 - 7.00	.009 - 3.70	.005 - 2.00	.004 - 1.00	
42	No Trip	.700 - 12.0	---	.400 - 6.00	.180 - 2.30	.050 - .600	.026 - .300	.018 - .200	.014 - .150	.012 - .130	
44	No Trip	7.00 - 100	---	3.00 - 50.0	1.10 - 18.0	.220 - 3.00	.120 - 1.70	.075 - 1.20	.050 - .850	.042 - .720	
46	No Trip	50.0 - 700	---	31.0 - 350	12.0 - 150	1.50 - 20.0	.700 - 10.0	.404 - 7.90	.260 - 6.50	.198 - 5.80	
52	No Trip	.500 - 6.50	---	.340 - 4.50	.180 - 2.30	.051 - .600	.030 - .320	.018 - .220	.014 - .200	.012 - .130	
54	No Trip	1.50 - 50.0	---	.750 - 35.0	.350 - 18.0	.110 - 3.00	.070 - 1.70	.045 - 1.40	.039 - 1.30	.035 - 1.30	
56	No Trip	45.0 - 345	---	19.0 - 170	8.50 - 100	1.24 - 15.0	.410 - 9.00	.256 - 8.00	.210 - 5.50	.198 - 2.90	

Notes:

UL489 C-Series Breakers available with Delay Curves 11, 12, 14, 16, 21, 22, 24, 26, 42, 44, 46.  
 Delay Curves 11, 12, 14, 16, 21, 22, 24, 26, 42, 44, 46, 52, 54, 56: Breakers to hold 100% and must trip at 125% of rated current and greater within the time limit shown in this curve.  
 Delay Curves 32, 34, 36: Breakers to hold 100% and must trip at 135% of rated current and greater within the time limit shown in this curve.  
 Delay Curves 10, 20: Breakers to hold 100% and must trip at 150% of rated current and greater within the time limit shown in this curve.  
 All Curves: Curve data shown represents breaker response at ambient temperature of 77°F (25°C) with no preloading. Breakers are mounted in standard wall-mount position.  
 On 50 amp and less current ratings, the minimum inrush pulse tolerance handling capability is 12 times the rated current on standard delays and 25 times the rated current on high inrush delays. These values are based on a 60 Hz 1/2 cycle, 8.33 ms pulse. High inrush delays should be specified for applications with high initial surge currents of short duration such as switching power supplies, highly capacitive loads and transformer loads.

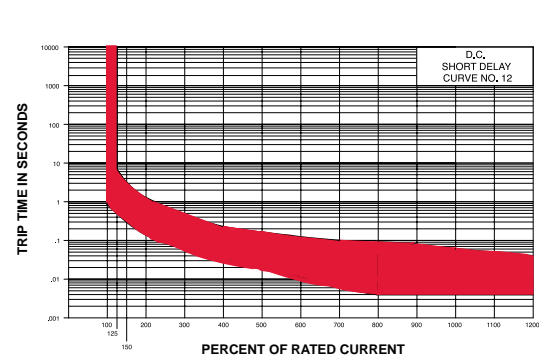
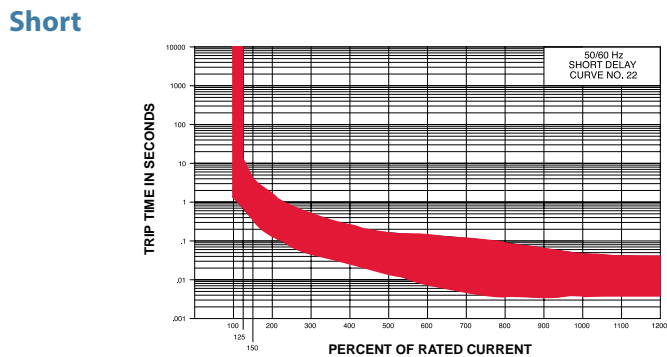
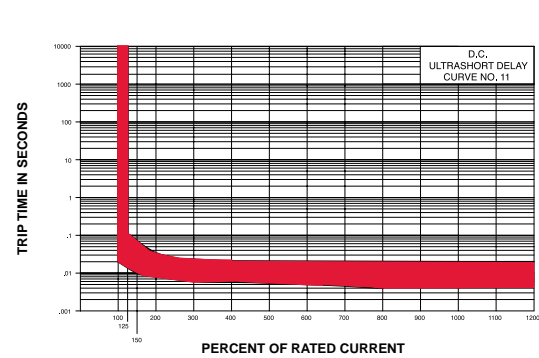
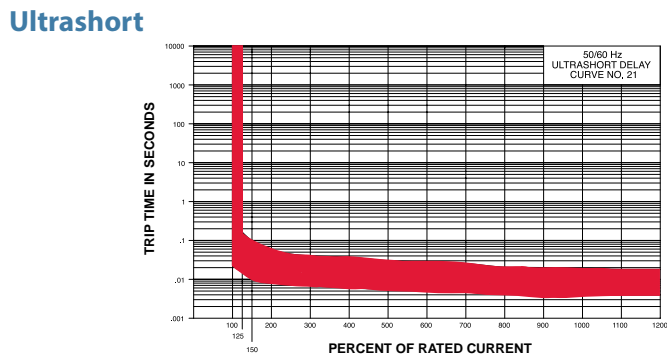
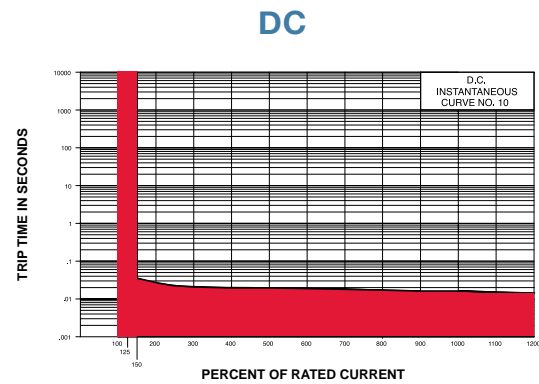
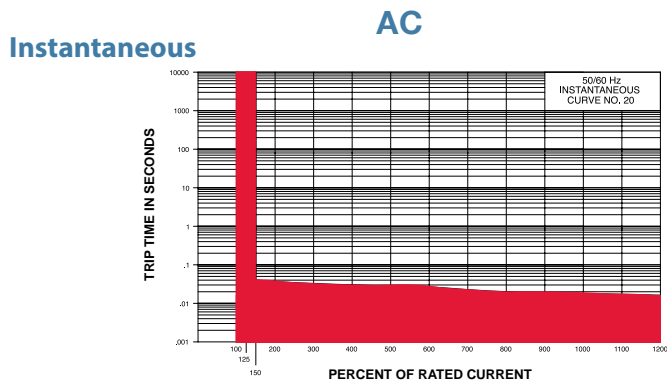



Medium

AC

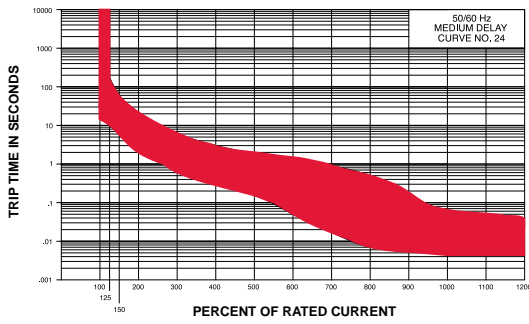

DC

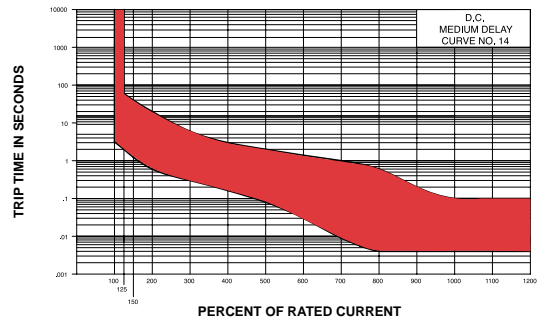

Long

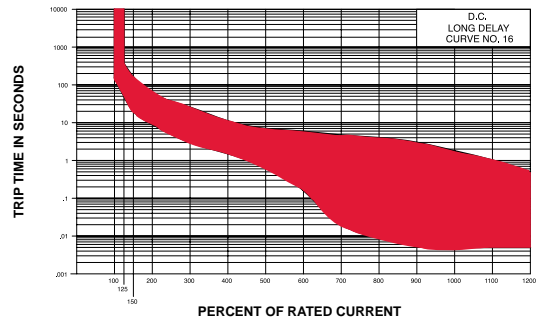
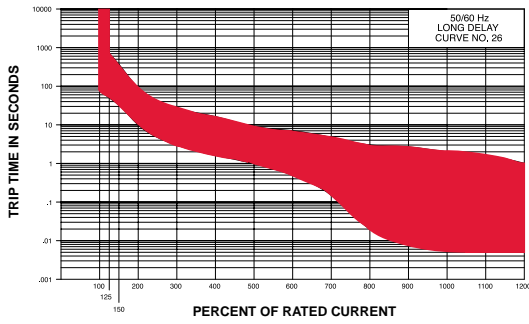

Short

High Inrush AC

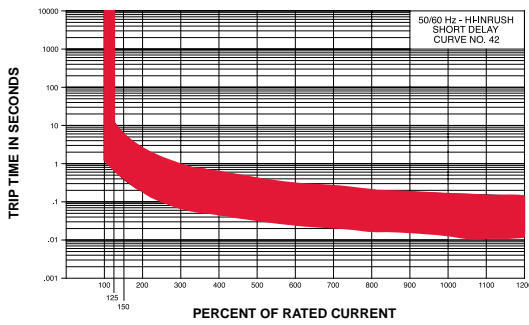

High Inrush DC

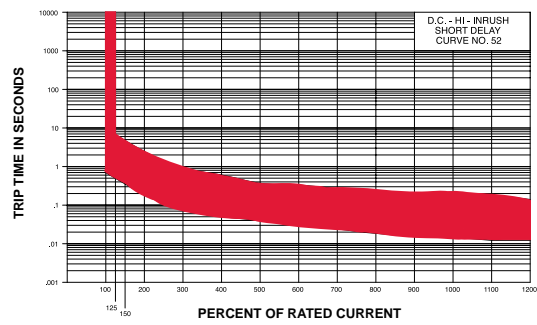

Medium

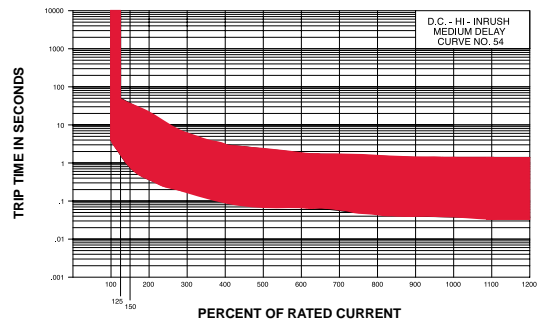
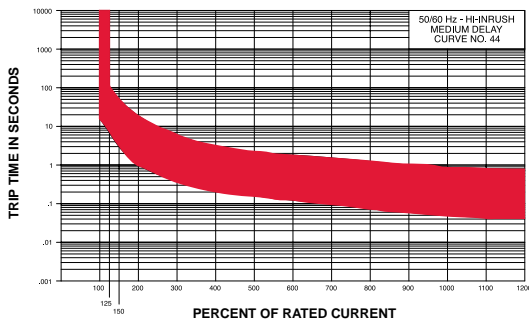

Long

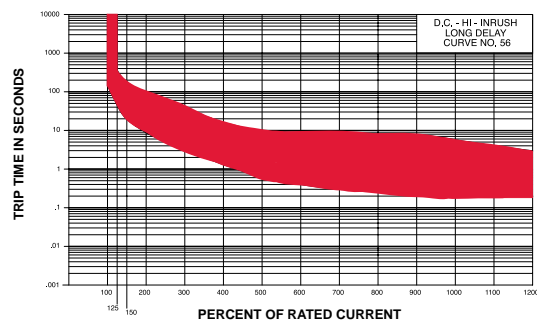

AC/DC

Short

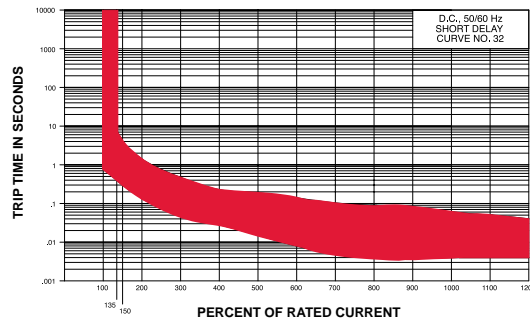

Medium

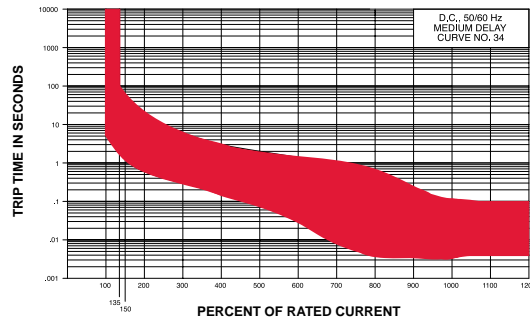

Long

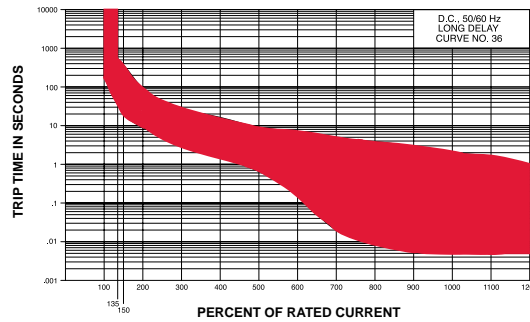

E-SERIES TIME DELAY VALUES											
TRIP TIME (SECONDS)	PERCENT OF RATED CURRENT										
	Delay	100%	125%	135%	150%	200%	400%	600%	800%	1000%	1200%
10	No Trip	May Trip	--	.001 - .038	.001 - .032	.001 - .021	.001 - .019	.001 - .019	.001 - .019	.001 - .019	.001 - .019
12, 72	No Trip	.600 - 7.00	--	.330 - 2.00	.150 - .800	.033 - .160	.016 - .071	.010 - .048	.008 - .040	.008 - .040	
14, 74	No Trip	11.0 - 110	--	6.00 - 45.0	3.00 - 18.0	.280 - 3.50	.013 - 1.50	.010 - .130	.009 - .090	.009 - .080	
16, 76	No Trip	100 - 800	--	50.0 - 360	20.0 - 120	3.00 - 25.0	.020 - 11.0	.010 - .700	.009 - .230	.009 - .200	
20	No Trip	May Trip	--	.001 - .040	.001 - .031	.001 - .020	.001 - .020	.001 - .020	.001 - .020	.001 - .020	
22, 62	No Trip	.800 - 5.00	--	.400 - 2.30	.150 - .900	.034 - .170	.020 - .080	.012 - .051	.010 - .040	.009 - .040	
24, 64	No Trip	7.20 - 90.0	--	4.40 - 35.0	2.00 - 15.0	.500 - 3.50	.025 - 1.60	.012 - .330	.010 - .070	.009 - .050	
26, 66	No Trip	50.0 - 500	--	32.0 - 250	14.0 - 120	2.50 - 24.0	.320 - 7.00	.0125 - 3.10	.011 - .130	.010 - .055	
30	No Trip	May Trip	--	.001 - .040	.001 - .032	.001 - .020	.001 - .020	.001 - .020	.001 - .020	.001 - .020	
32, 92	No Trip	May Trip	.450 - 5.20	.330 - 2.30	.150 - .900	.033 - .170	.016 - .080	.009 - .051	.008 - .040	.008 - .040	
34, 94	No Trip	May Trip	5.80 - 73.0	4.40 - 45.0	2.00 - 18.0	.280 - 3.60	.013 - 1.60	.010 - .330	.009 - .090	.009 - .080	
36, 96	No Trip	May Trip	42.0 - 600	32.0 - 360	14.0 - 120	2.50 - 25.0	.020 - 11.0	.010 - 4.10	.009 - .330	.009 - .200	

NOTES

Delay Curves 10,20,30: Breakers to hold 100% and must trip at 150% of rated current and greater within the time limit shown in these curves.  
 Delay Curves 12,14,16,22,24,26,62,64,66,72,74,76: Breakers to hold 100% and must trip at 125% of rated current and greater within the time limit shown in these curves.  
 Delay Curves 32,34,36,92,94,96: Breakers to hold 100% and must trip at 135% of rated current and greater within the time limit shown in these curves.  
 All curves: Data shown represents breaker response at ambient temperature of 77°F (25°C) with no preloading; Breakers are mounted in standard wall-mount position.  
 The minimum inrush pulse tolerance handling capacity on the above standard delays is 16 times rated current & 20 times rated current for high inrush delays based on a 60Hz 1/2 cycle, 8.33 ms pulse.

Instantaneous

AC

DC

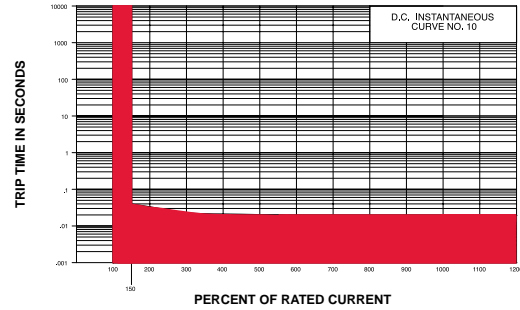
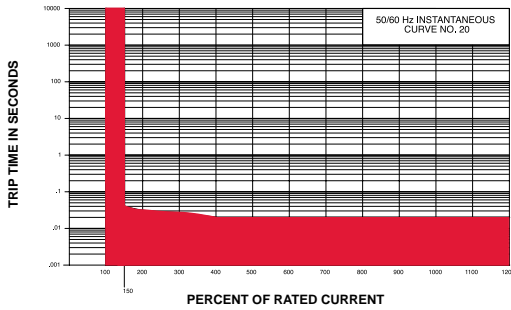

Short

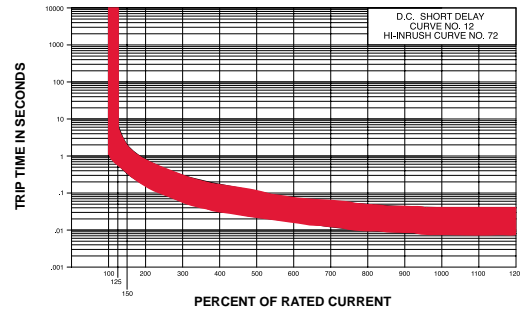
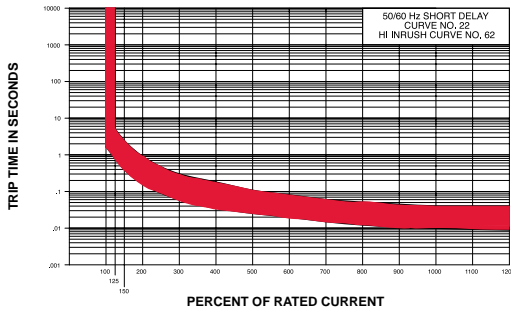

Medium

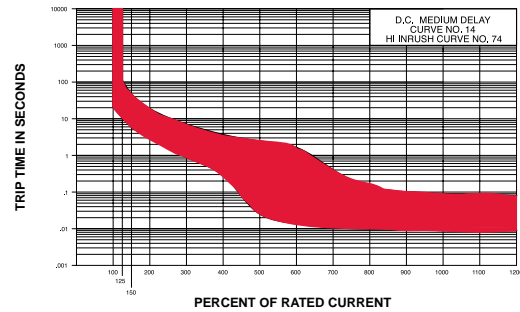
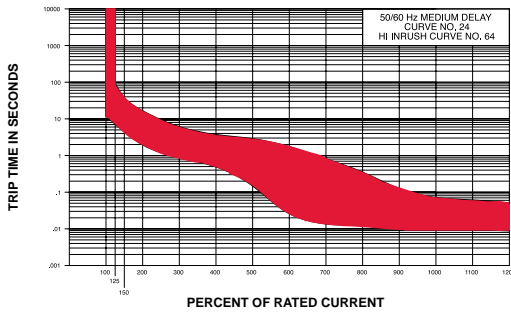

Long

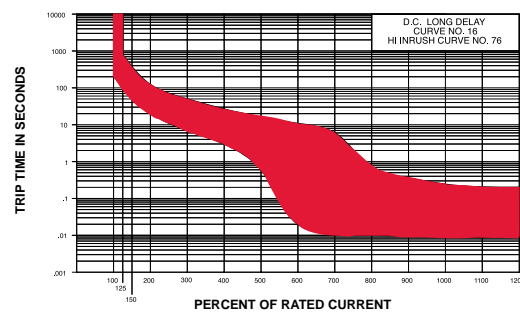
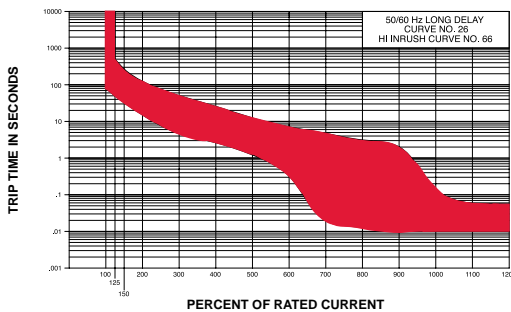

AC/DC

Instantaneous

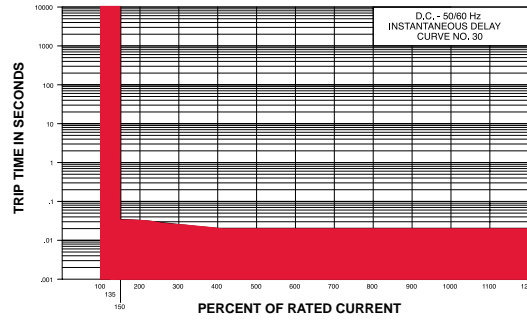

Short

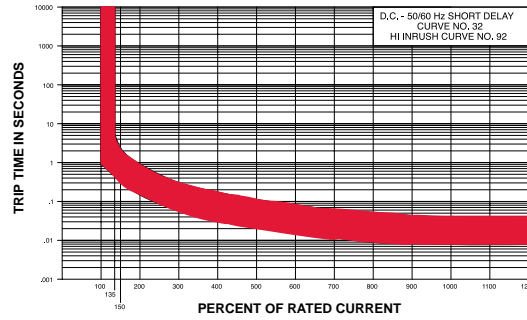

Medium

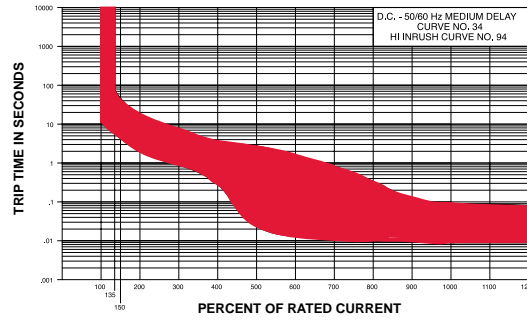

Long

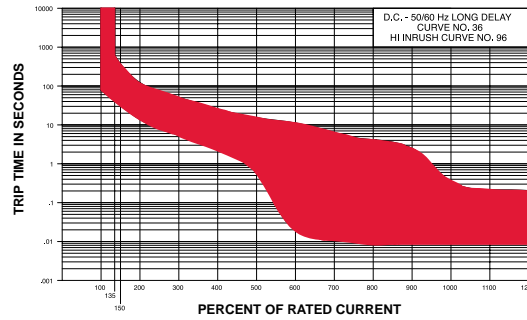

# CMB-Series

## THERMAL CIRCUIT PROTECTORS

The CMB-Series is a compact, single pole, push-to-reset family of thermal circuit breakers designed to protect equipment. Utilizing simple, precision design with few moving parts, these breakers offer cost effective, extremely reliable circuit protection with high resistance against shock and vibration.



### Product Highlights:

- Ratings from 3-20A, 125, 250VAC, 32VDC
- 2500 VAC/1 minute
- 60°C Max Operating Temperature
- 2500A @ 32VDC Interrupting Capacity
- 100M ohms Insulation Resistance
- Voltage drop <0.25 V
- UL, CUL, CSA, TUV, CE
- UL1500/ISO8846 for ignition protection/marine

### Dimensional Specifications: in. [mm]

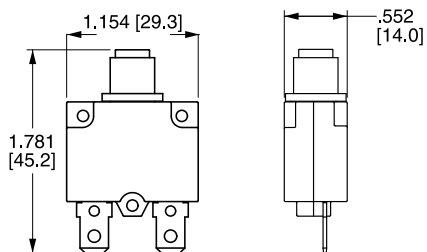

**CMB - 10 3 - 11 C 3 N - B - A /10**

1 Series      2 Rating      3 Voltage      4 Mounting Hole      5 Bushing Type      6 Mounting Nut      7 Indicator Plate      8 Button      9 Terminal      10 Button Marking

**1 SERIES**  
CMB

**3 VOLTAGE**  
3 125-250VAC/ 32 VDC

**2 RATING**

03	3 amps	10	10 amps
04	4 amps	12	12 amps
05	5 amps	13	13 amps
06	6 amps	14	14 amps
07	7 amps	15	15 amps
08	8 amps	16	16 amps
		20	20 amps

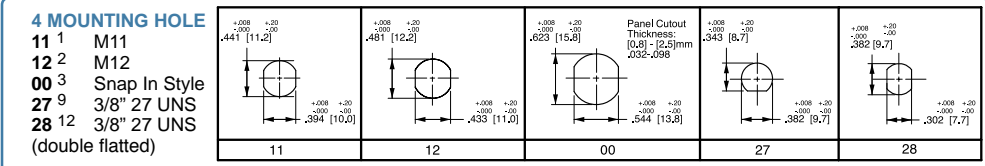

**5 BUSHING**

**PLASTIC**

C<sup>4</sup> Type C  
D<sup>4</sup> Type D  
E<sup>5</sup> Type E  
G<sup>6</sup> Type G  
H<sup>8</sup> Type H  
K<sup>13</sup> Type K

**METAL**

J<sup>8</sup> Type J

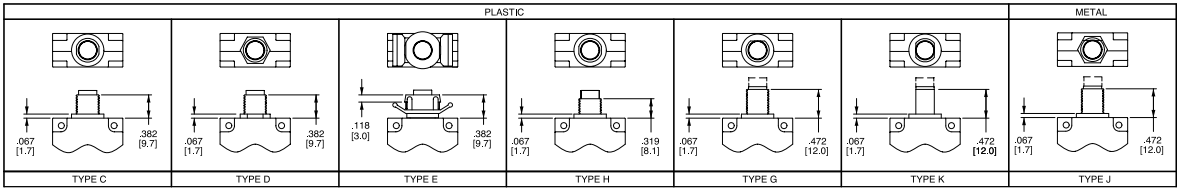

**6 MOUNTING NUT 7**

N None  
1 Type 1  
2 Type 2  
3<sup>11</sup> Type 3  
4 Type 4  
5 Type 5  
6<sup>14</sup> Type 6  
7<sup>9</sup> Type 7  
8<sup>9</sup> Type 8

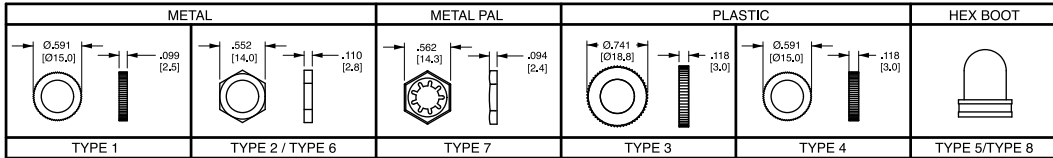

NOTE: Type 5 is clear hex boot. Type 8 is black hex boot (available for bushings G, J & K only); Type 3 nut includes molded in "PRESS TO RESET" marking.

**7 INDICATOR PLATE 7**

N None  
A Embossed Legend  
B Silver Printing on Black

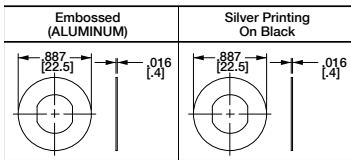

All indicator plates are marked "Suppl. Prot. press to reset".

Notes: All dimensions are in [mm]. Tolerance  $\pm 0.05$  [1.27] unless otherwise specified.

- |   |   |
|---|---|
| 1 Used with bushing C or D only.                      | 9 Available with G, J or K bushing only.  |
| 2 Used with H bushing only.                           | 10 Amp rating must match button marking (ex: 20 will be marked on the button of CMB-203-27G3N-W-A/20) |
| 3 Used with bushing E only.                           | 11 Includes molded in "PRESS TO RESET" marking.   |
| 4 Used with M11 mounting hole only.                   | 12 Available with K bushing only.   |
| 5 Used with mounting hole 00 only.                    | 13 Available with mounting hole 28 only.  |
| 6 Used with M12 mounting hole only.                   | 14 Thickness is 3.0 mm, .118 in.  |
| 7 All hardware available separately. Consult factory. |   |
| 8 Available with mounting hole 27 only.               |   |

**8 BUTTON**

B Black      R Red      W White

**9 TERMINAL**

A Type A      F Type F  
B Type B      G Type G  
C Type C      H Type H  
D Type D      J Type J  
E Type E

F,G,H,J TERMINALS ARE 8-32 UNC

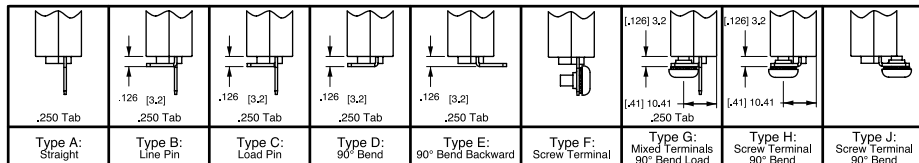

**10 BUTTON MARKING (IF BLANK, NO MARKING.)<sup>10</sup>** Button Marking Orientation: line  (20)  load

03	3 amp	05	5 amp	07	7 amp	10	10 amp	13	13 amp	15	15 amp	20	20 amp
04	4 amp	06	6 amp	08	8 amp	12	12 amp	14	14 amp	16	16 amp		

**Time Delay**

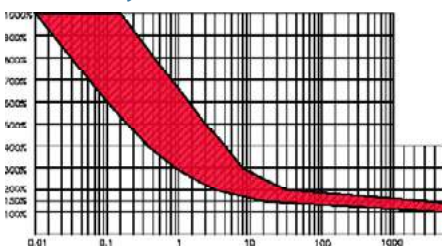

Derating Factor	
-10 °C	x 1.70
-5 °C	x 1.60
0 °C	x 1.50
5 °C	x 1.40
10 °C	x 1.30
15 °C	x 1.20
20 °C	x 1.10
25 °C	x 1.00

Derating Factor	
30 °C	x 0.90
35 °C	x 0.85
40 °C	x 0.80
45 °C	x 0.75
50 °C	x 0.70
55 °C	x 0.65
60 °C	x 0.60

Overload	Trip Time
100%	No Trip
150%	Trip in 1 hr
200%	4.0 ~ 40 sec.
300%	0.9 ~ 8.0 sec.
400%	.42 ~ 5.0 sec.
500%	.25 ~ 3.0 sec.
600%	.01 ~ 1.8 sec.

Notes:  
Breaker must hold 100% of rated current and must trip at 150% and above, within the time limits shown in curve. Trip times specified at 25° ambient with no preloading.

1 To adjust the breaker rating for ambient temperature multiply the breaker rating by the factor. (ex: 5 amp rating at 0°C: 5 x .67 = 3.3 amp. Select 3 amp rating.)

\*Manufacturer reserves the right to change product specification without prior notice.

# CLB-Series

## THERMAL CIRCUIT PROTECTORS

The CLB-Series is a compact, single pole, push-to-reset family of thermal circuit breakers designed to protect equipment. Utilizing simple, precision design with few moving parts, these breakers offer cost effective, extremely reliable circuit protection with high resistance against shock and vibration.



### Product Highlights:

- Ratings from 3-60A, 125, 250VAC, 32VDC
- 2500 VAC/1 minute
- 60°C Max Operating Temperature
- 2500A @ 32VDC Interrupting Capacity
- 100M ohms Insulation Resistance
- Voltage drop <0.25 V
- UL, CUL, CSA, TUV, CE
- UL1500/ISO8846 for ignition protection/marine

### Dimensional Specifications: in. [mm]

#### 3-40A Construction

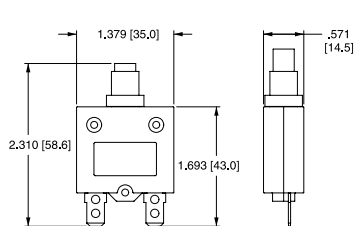

#### 50 & 60A Construction

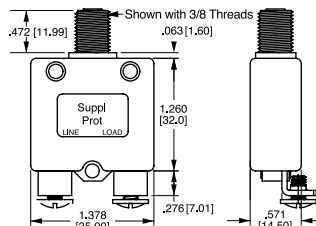

**CLB - 10 3 - 12 C 3 N - B - A / 10**

1 Series      2 Rating      3 Voltage      4 Mounting Hole      5 Bushing Type      6 Mounting Nut      7 Indicator Plate      8 Button      9 Terminal      10 Button Marking

**1 SERIES**  
**CLB**

**3 VOLTAGE**  
**3** 125-250VAC/ 32 VDC

**2 RATING**

03	3 amps	15	15 amps
04	4 amps	18	18 amps
05	5 amps	20	20 amps
06	6 amps	25	25 amps
07	7 amps	30	30 amps
08	8 amps	35	35 amps
10	10 amps	40	40 amps
12	12 amps	50	50 amps
13	13 amps	60	60 amps

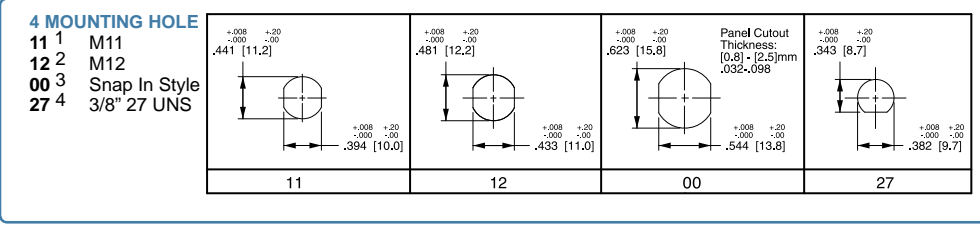

**5 BUSHING**

**METAL**

A<sup>6</sup> Type A  
B<sup>6</sup> Type B  
J<sup>8</sup> Type J

**PLASTIC**

C<sup>5</sup> Type C  
D<sup>7</sup> Type D  
E<sup>8</sup> Type E

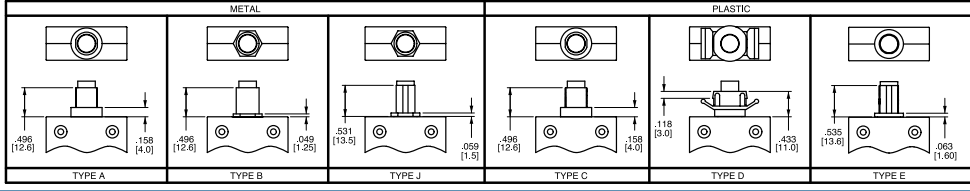

**6 MOUNTING NUT 9**

N None  
1 Type 1  
2 Type 2  
3 Type 3  
4 Type 4  
5 Type 5  
6<sup>4, 14</sup> Type 6  
7<sup>4</sup> Type 7  
8<sup>4</sup> Type 8

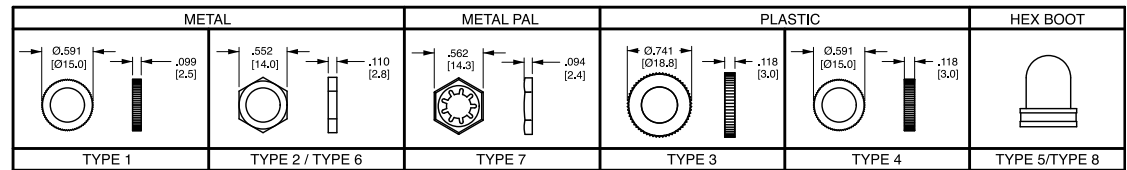

NOTE: Type 5 is clear hex boot. Type 8 is black hex boot (available for bushings E & J only); Type 3 nut includes molded in "PRESS TO RESET" marking.

**7 INDICATOR PLATE 9**

N None  
A Embossed  
B Silver Printing on Black

All indicator plates are marked "Suppl. Prot. press to reset".

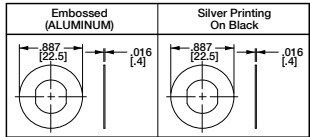

- Notes: All dimensions are in [mm]. Tolerance ±.005 [.127] unless otherwise specified.
- Used with bushing A or B only.
  - Used with bushing C only.
  - Used with bushing D only.
  - Used with bushing E & J only.
  - Used with M12 mounting hole only.
  - Used with M11 mounting hole only.
  - Used with mounting hole 00 only.
  - Used with 27 mounting hole only.
  - All hardware available separately. Consult factory.
  - > 35 amp ratings must use solder joint to connect wire to non-screw type terminals.
  - Terminals are .040 [1.0] thickness for ratings- 35, & .315 [8] thickness is for ratings < 35 amps.
  - Available only with 10-24 unc. screw terms. (select type F, G, H, J only.) UL, CUL only.
  - Amp rating must match button marking (ex: "20" will be marked on the button of the breaker)
  - Thickness is 3.0 mm, .118 in.
  - Screw terminals are 8-32 UNC

**8 BUTTON**

B Black      R Red      W White

**9 TERMINAL 10,11,15**

A Type A  
B Type B  
C Type C  
D Type D  
E Type E

F Type F  
G Type G  
H Type H  
J Type J

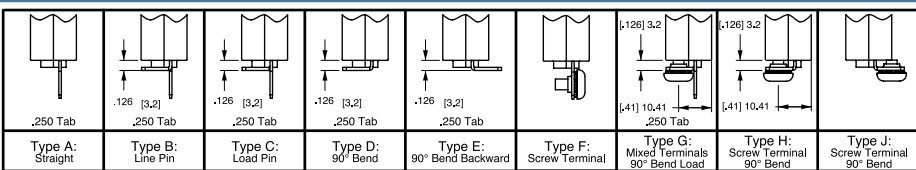

**10 BUTTON MARKING (IF BLANK, NO MARKING.)<sup>13</sup> Button Marking Orientation:** line load

03	3 amp	06	6 amp	10	10 amp	15	15 amp	25	25 amp	40	40 amp
04	4 amp	07	7 amp	12	12 amp	18	18 amp	30	30 amp	50	50 amp
05	5 amp	08	8 amp	13	13 amp	20	20 amp	35	35 amp	60	60 amp

**Time Delay**

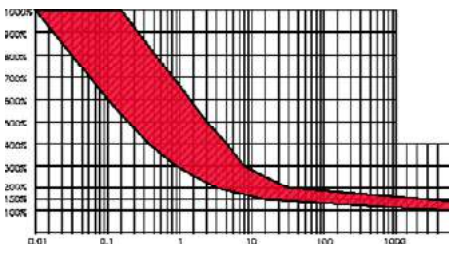

Derating Factor		Derating Factor		Overload	Trip Time
-10 °C	x 1.70	30 °C	x 0.90	100%	No Trip
-5 °C	x 1.60	35 °C	x 0.85	150%	Trip in 1 hr
0 °C	x 1.50	40 °C	x 0.80	200%	4.0 ~ 40 sec.
5 °C	x 1.40	45 °C	x 0.75	300%	0.9 ~ 8.0 sec.
10 °C	x 1.30	50 °C	x 0.70	400%	.42 ~ 5.0 sec.
15 °C	x 1.20	55 °C	x 0.65	500%	.25 ~ 3.0 sec.
20 °C	x 1.10	60 °C	x 0.60	600%	.01 ~ 1.8 sec.
25 °C	x 1.00				

Notes:

Breaker must hold 100% of rated current and must trip at 150% and above, within the time limits shown in curve. Trip times specified at 25° ambient with no preloading.

1 To adjust the breaker rating for ambient temperature multiply the breaker rating by the factor. (ex: 5 amp rating at 0°C: 5 x .67 = 3.3 amp. Select 3 amp rating.)

\*Manufacturer reserves the right to change product specification without prior notice.



# CMBA/CLBA-Series

## THERMAL CIRCUIT PROTECTORS

The CMBA/CLBA-Series features automatic cycling and resetting thermal protection capabilities with the same performance as its traditional push-to-reset counterparts.



### Product Highlights:

- ♦ CMBA: 3-20A, 125, 250VAC, 32VDC
- ♦ CLBA: 3-40A, 125, 250VAC, 32VDC
- ♦ 2500 VAC/1 minute
- ♦ 60°C Max Operating Temperature
- ♦ 2500A @ 32VDC Interrupting Capacity
- ♦ 100M ohms Insulation Resistance
- ♦ Voltage drop <0.25 V
- ♦ UL, cUL, TUV

### Dimensional Specifications: in. [mm]

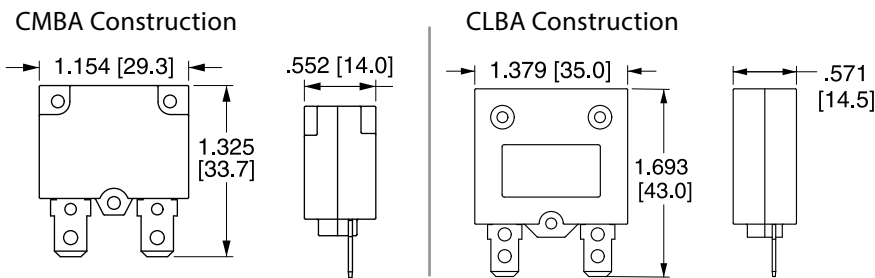

CMBA - 
 10
3 - 
 NN
F
N
N - 
 B - 
 A
 

1 Series      2 Rating      3 Voltage      4 Mounting      5 Bushing      6 Mounting Nut      7 Indicator Plate      8 Button Color      9 Terminal      10 Plug Marking

**1 SERIES**  
CMBA

**2 RATING <sup>2</sup>**

<b>03</b> 3 amps	<b>10</b> 10 amps
<b>04</b> 4 amps	<b>12</b> 12 amps
<b>05</b> 5 amps	<b>13</b> 13 amps
<b>06</b> 6 amps	<b>15</b> 15 amps
<b>07</b> 7 amps	<b>18</b> 18 amps
<b>08</b> 8 amps	<b>20</b> 20 amps

**3 VOLTAGE**  
3 125-250VAC/ 32 VDC

**4 MOUNTING**  
NN Plug In

**5 BUSHING**  
F None

**6 MOUNTING NUT**  
N N/A

**7 INDICATOR PLATE**  
N N/A

**8 BUTTON COLOR**  
B Flush Black

**9 TERMINAL**  
A Type A

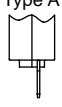

.250 Tab

**10 BUTTON MARKING <sup>1</sup> (IF BLANK, NO MARKING)**

Plug Marking Orientation: line 20 load

<b>03</b> 3 amp	<b>07</b> 7 amp	<b>13</b> 13 amp
<b>04</b> 4 amp	<b>08</b> 8 amp	<b>15</b> 15 amp
<b>05</b> 5 amp	<b>10</b> 10 amp	<b>18</b> 18 amp
<b>06</b> 6 amp	<b>12</b> 12 amp	<b>20</b> 20 amp

CLBA - 
 10
3 - 
 NN
F
N
N - 
 B - 
 A
 

1 Series      2 Rating      3 Voltage      4 Mounting      5 Bushing      6 Mounting Nut      7 Indicator Plate      8 Button Color      9 Terminal      10 Plug Marking

**1 SERIES**  
CLBA

**2 RATING <sup>2</sup>**

<b>03</b> 3 amps	<b>13</b> 13 amps
<b>04</b> 4 amps	<b>15</b> 15 amps
<b>05</b> 5 amps	<b>18</b> 18 amps
<b>06</b> 6 amps	<b>20</b> 20 amps
<b>07</b> 7 amps	<b>25</b> 25 amps
<b>08</b> 8 amps	<b>30</b> 30 amps
<b>10</b> 10 amps	<b>35</b> 35 amps
<b>12</b> 12 amps	<b>40</b> 40 amps

**3 VOLTAGE**  
3 125-250VAC/ 32 VDC

**4 MOUNTING**  
NN Plug In

**5 BUSHING**  
F None

**6 MOUNTING NUT**  
N N/A

**7 INDICATOR PLATE**  
N N/A

**8 BUTTON COLOR**  
B Flush Black

**9 TERMINAL**  
A Type A

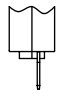

.250 Tab

**10 BUTTON MARKING <sup>1</sup> (IF BLANK, NO MARKING)**

Plug Marking Orientation: line 20 load

<b>03</b> 3 amp	<b>07</b> 7 amp	<b>13</b> 13 amp	<b>25</b> 25 amp
<b>04</b> 4 amp	<b>08</b> 8 amp	<b>15</b> 15 amp	<b>30</b> 30 amp
<b>05</b> 5 amp	<b>10</b> 10 amp	<b>18</b> 18 amp	<b>35</b> 35 amp
<b>06</b> 6 amp	<b>12</b> 12 amp	<b>20</b> 20 amp	<b>40</b> 40 amp

- Notes:
- 1 Amp rating must match plug marking. (ex: "20" will be marked on the plug of the breaker)  
No marking is standard.
  - 2 See CMB/CLB graph for time delay information.

\*Manufacturer reserves the right to change product specification without prior notice.

# PB-Series

## GFCI/ELCI & PANEL SEAL

The new PB-Series, AC Residual Current Circuit Breaker with Overcurrent Protection (RCBO), combines the ground fault protection of a GFCI with the familiar overcurrent tripping characteristics of a normal circuit breaker. It utilizes the hydraulic magnetic principle which provides precise operation and performance even when exposed to extremely hot and/or cold application environments. These precision mechanisms are temperature stable and are not adversely affected by temperature changes in their operating environment. As such, derating considerations due to temperature variations are not normally required, and heat-induced nuisance tripping is avoided.



### Resources:

Download 3D CAD Files

[IGS >](#)

[STP >](#)

### Product Highlights:

- Overload, short circuit and ground fault protection in a single package
- Handle or rocker style actuators
- Wiping Contacts - Mechanical linkage with two-step actuation - cleans contacts, provides high, positive contact pressure & longer contact life.
- A trip-free mechanism, a safety feature which makes it impossible to manually hold the contacts closed during overload or fault conditions.
- A common trip linkage between all poles, another safety feature, ensures that an overload in one pole will trip all adjacent poles.
- Front panel mounting
- Integral push-to-test button

### Benefits:

- Increases safety around boats and marinas
- Protects against electrical shock hazards in areas near water
- Protects against defects in wires & conductors
- Reduces fire and shock hazards from defects in permanently installed appliances such as water heaters, battery chargers, lighting fixtures, etc.
- Detects lower level ground faults which do not trip ordinary circuit breakers, but can lead to fires, and shock hazards for boating occupants

### Electrical Tables

**Table A:** UL Listed configurations and performance capabilities as Circuit Breakers.

PB-SERIES TABLE A					
Circuit Configuration	Voltage			Current Rating (Amps)	Interrupting Capacity (Amps)
	Max Rating	Frequency	Phase		
Series	120	60	1	.10 - 30	5000

### Electrical

**Maximum Voltage** 120/240VAC 60 Hz  
**Current Ratings** Standard current coils: 0.100, 0.250, 0.500, 0.750, 1.00, 2.50, 5.00, 7.50, 10.0, 15.0, 20.0, 25.0 & 30.0 amps. Other ratings available, see ordering scheme.  
**Insulation Resistance** Minimum of 100 Megohms at 500 VDC.  
**Dielectric Strength** UL, CUL - 1500 V 60 Hz for one minute between all electrically isolated terminals. PB-Series circuit breakers comply with the 8mm spacing and 3750V 60 Hz dielectric requirements from hazardous voltage to operator accessible surfaces and between adjacent poles  
**Impedance** Values from Line to Load Terminal

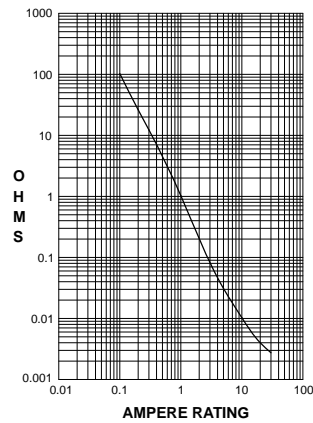

Ampere Rating

CURRENT (AMPS)	TOLERANCE (%)
0.10 - 5.0	± 15
5.10 - 20.0	± 25
20.10 - 30.0	± 35

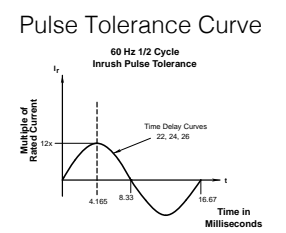

### Leakage To Ground

**Standard Must Trip** 120/240VAC 60 Hz  
**Leakage Current Ratings** 5 & 30 milliamps. 5± 1mA  
 For other ratings, consult factory.  
**Trip Time** 300 ms Max. @ 100%, 40ms Max. @ 500% of must trip leakage current.  
**Test Button actuator.** On unit face along side of

### Mechanical

**Endurance** 10,000 ON-OFF operations @ 6 per minute; with rated Current & Voltage.  
**Trip Free** All PB-Series Circuit Breakers will trip on overload or ground fault, even when Handle is forcibly held in the ON position.  
**Trip Indication** The operating Handle moves positively to the OFF position when an overload or ground fault causes the breaker to trip.

### Physical

**Number of Poles** 1 - 3 poles, where the third pole is neutral  
**Internal Circuit Config.** Series Trip  
**Weight** Approximately 65 grams/pole. (2.32 ounces/pole.)  
**Standard Colors** Housing- Black; Actuator - See Ordering Scheme.

### Environmental

Designed and tested in accordance with requirements of specification MIL-PRF- 55629 and MIL-STD-202 as follows:  
**Shock** Withstands 100 Gs, 6ms, sawtooth while carrying rated current per Method 213, Test Condition "I". Ultra-short curves tested @ 90% of rated current.  
**Vibration** Withstands 0.060" excursion from 10-55 Hz, and 10 Gs 55-500 Hz, at rated current per Method 204C, Test Condition A. Instantaneous and ultrashort curves tested at 90% of rated current.  
**Moisture Resistance** Method 106D, i.e., ten 24-hour cycles @ + 25°C to +65°C, 80-98% RH.  
**Salt Spray** Method 101, Condition A (90-95% RH @ 5% NaCl Solution, 96 hrs).  
**Thermal Shock** Method 107D, Condition A (Five cycles @ -55°C to +25°C to +85°C to +25°C).  
**Operating Temperature** -35° C to +65° C  
**Corrosion** Tested FMG Test. 3 weeks @ 30°C 75% RH, 100ppb H2S, 20ppb Cl2, 200ppb NO2

### Agency Certifications

**UL Listed**  
 UL Standard 489 Circuit Breakers, Molded Case, (Guide DIVQ, File E129899)  
 UL Standard 1077 Supplementary Protectors  
 UL Standard 1053 Ground Fault Sensing and Relaying Equipment

\*Manufacturer reserves the right to change product specification without prior notice.

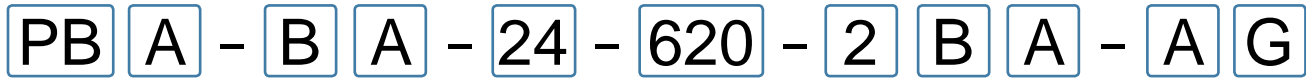

1 Series    2 System Voltage/Poles    3 Circuit    4 Actuator    5 Frequency & Delay    6 Current Rating    7 Terminal    8 Actuator Color    9 Mounting/Barriers    10 Trip Level    11 Agency Approval

**1 SERIES**  
**PB**

**2 SYSTEM VOLTAGE / POLES**  
**A** 120 VAC single phase, one pole  
**B** 120/240 VAC single phase, two pole  
**C** 120/240 VAC single phase with switched neutral, three pole  
**D** 120 VAC two pole with switched neutral

**3 CIRCUIT**  
**B** Series Trip (Current)

**4 ACTUATOR 1**  
**Handle**  
**A** one per pole  
**B** one per multipole unit  
**Two Color Curved Visi-Rocker**  
**C** Indicate ON, vertical legend  
**D** Indicate ON, horizontal legend  
**F** Indicate OFF, vertical legend  
**G** Indicate OFF, horizontal legend  
**Single Color Curved Rocker**  
**J** Vertical legend  
**K** Horizontal legend  
**Two Color Flat Visi-Rocker**  
**1** Indicate OFF, vertical legend  
**2** Indicate OFF, horizontal legend  
**Single Color Flat Rocker**  
**3** Vertical legend  
**4** Horizontal legend

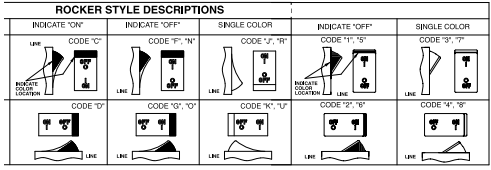

**5 FREQUENCY & DELAY**  
**22** 60Hz Short  
**24** 60Hz Medium  
**26** 60Hz Long

**6 CURRENT RATING (AMPERES)**

CODE	AMPERES	CODE	AMPERES	CODE	AMPERES	CODE	AMPERES
210	0.100	285	0.850	450	5.000	712	12.500
215	0.150	290	0.900	455	5.500	613	13.000
220	0.200	295	0.950	460	6.000	614	14.000
225	0.250	410	1.000	465	6.500	615	15.000
230	0.300	512	1.250	470	7.000	616	16.000
235	0.350	415	1.500	475	7.500	617	17.000
240	0.400	517	1.750	480	8.000	618	18.000
245	0.450	420	2.000	485	8.500	620	20.000
250	0.500	522	2.250	490	9.000	622	22.000
255	0.550	425	2.500	495	9.500	624	24.000
260	0.600	527	2.750	610	10.000	625	25.000
265	0.650	430	3.000	710	10.500	630	30.000
270	0.700	435	3.500	611	11.000		
275	0.750	440	4.000	711	11.500		
280	0.800	445	4.500	612	12.000		

**7 TERMINAL 2**  
**1**<sup>3</sup> Push-On 0.250 Tab (Q.C.)    **B** Screw M5 w/upturned lugs  
**2** Screw 8-32 w/upturned lugs    **C** Screw M4 w/upturned lugs  
**3** Screw 8-32 (Bus Type)    **E** Screw M4 (Bus Type)  
**4** Screw 10-32 w/upturned lugs    **H** Screw M5 (Bus Type)  
**5** Screw 10-32 (Bus Type)

**8 ACTUATOR COLOR & LEGEND**

Handle Actuator Color	I-O	ON-OFF	Dual	Single	Rocker Actuator Color	Visi-Rocker
White	A	B	1	Black	White	White
Black	C	D	2	White	N/A	N/A
Red	F	G	3	White	Red	Red
Green	H	J	4	White	Green	Green
Blue	K	L	5	White	Blue	Blue
Yellow	M	N	6	Black	Yellow	Yellow
Gray	P	Q	7	Black	Gray	Gray
Orange	R	S	8	Black	Orange	Orange

**9 MOUNTING/BARRIERS**  
**MOUNTING STYLE**    **BARRIERS**  
**Threaded Insert, 2 per pole**  
**A** 6-32 X 0.195 inches    yes  
**B** ISO M3 x 5mm    yes

**10 LEAKAGE CURRENT TRIP LEVEL - MAX. TRIP CURRENT**  
**A** 5 MA (CLASS A GFCI)<sup>3,4</sup>  
**E** 30 MA (ELCI)

**11 AGENCY APPROVAL**  
**G** UL489 Listed, CSA Certified  
**C** UL1077  
**I** UL1077/UL1500 Ignition Protected<sup>5</sup>

- Notes:  
1 Actuator Code:  
A: Handle tie pin spacer(s) and retainers provided unassembled with multi-pole units.  
B: Handle location as viewed from front of breaker:  
2 pole - left pole    3 pole - center pole  
2 Screw Terminals are recommended on ratings greater than 20 amps.  
3 Available with leakage current trip level - Max trip current code E, and agency approval C.  
4 30mA per UL1053, available with agency approval codes C & G.  
5 UL1500 only available with 30MA trip level.

### Dimensional Specifications: in. [mm]

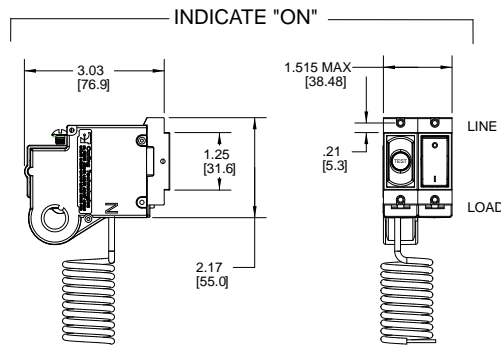

1-POLE 120 VAC VERSION

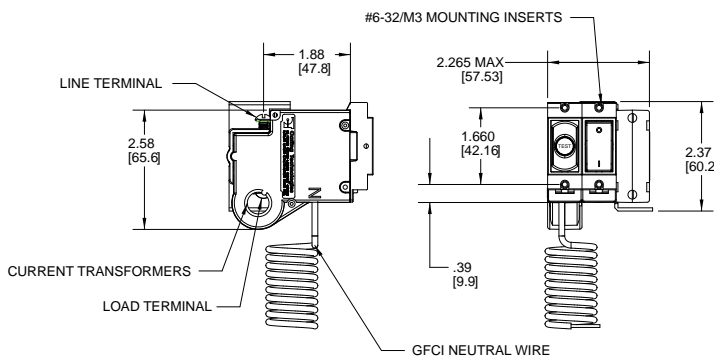
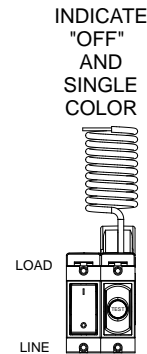

2-POLE 120/240 VAC VERSION

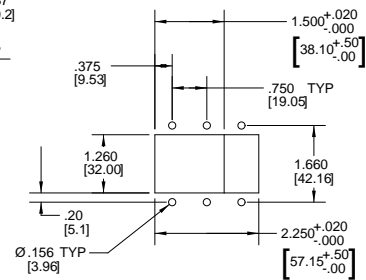

PANEL CUTOUT

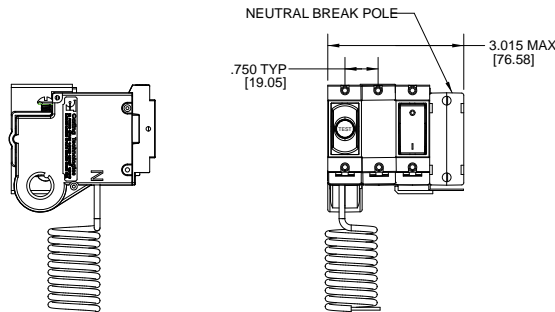

2-POLE 120/240 VAC WITH NEUTRAL BREAK

#### TERMINAL DIMENSIONAL DETAIL & RATING

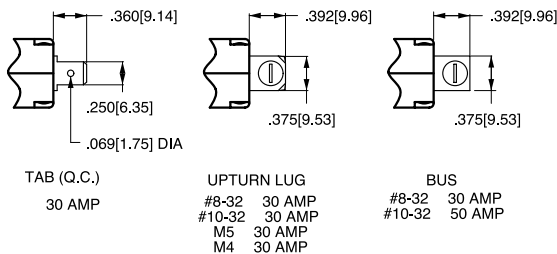

TAB (Q.C.)

30 AMP

UPTURN LUG

#8-32 30 AMP  
#10-32 30 AMP  
M5 30 AMP  
M4 30 AMP

BUS

#8-32 30 AMP  
#10-32 50 AMP

Notes:

- 1 All dimensions are in inches [millimeters].
- 2 Tolerance  $\pm 0.020$  [5.1] unless otherwise specified.

TABLE A  
TIGHTENING TORQUE  
SPECIFICATIONS

THREAD SIZE	TORQUE
#6-32 & M3 MOUNTING HARDWARE	7-9 IN-LBS [0.8-1.0 NM]
#8-32 & M4 THREAD TERMINAL SCREW	12-15 IN-LBS [1.4-1.7 NM]
#10-32 & M5 THREAD TERMINAL SCREW	15-20 IN-LBS [1.7-2.3 NM]

Dimensional Specifications: in. [mm]

TYPICAL 1-POLE 120 VAC VERSION

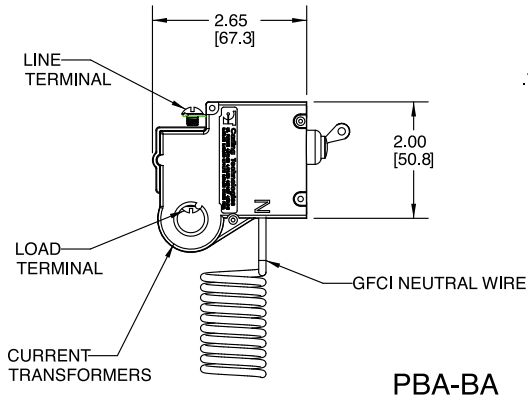

TYPICAL 2-POLE 120/240 VAC WITH NEUTRAL BREAK VERSION

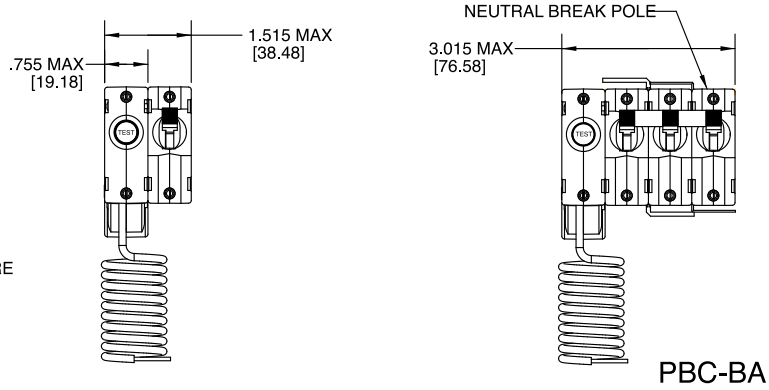

TYPICAL 2-POLE 120/240 VAC VERSION

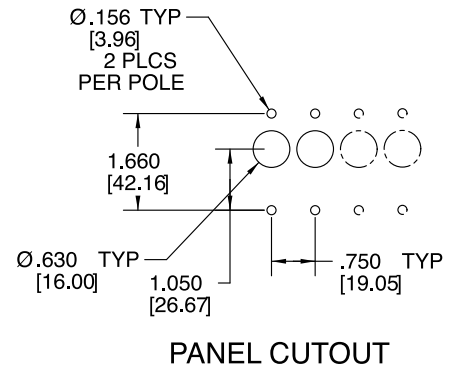
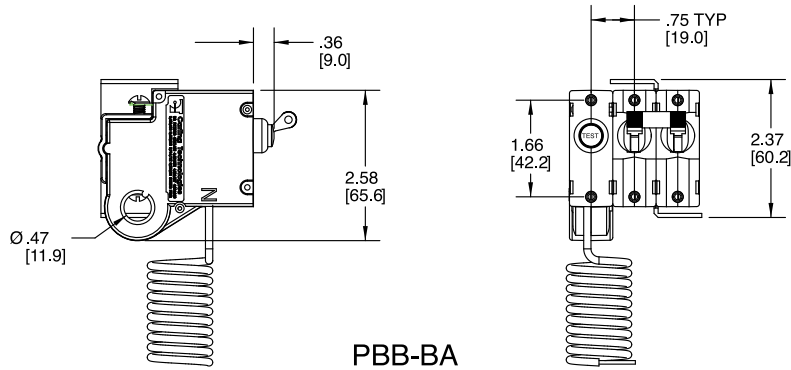

Notes:

- 1 All dimensions are in inches [millimeters].
- 2 Tolerance  $\pm 0.020$  [.51] unless otherwise specified.

### 120 VAC with Switched Neutral

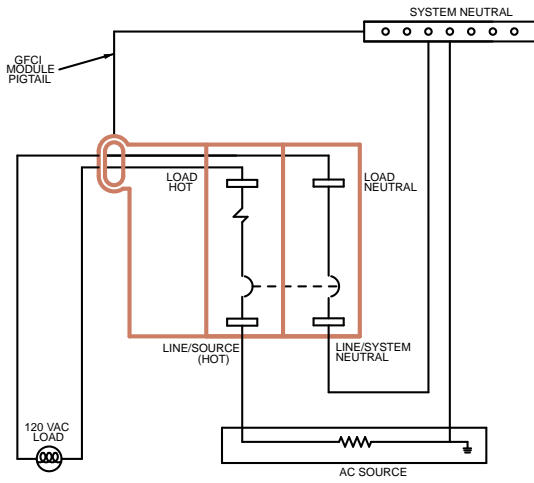

120 VAC WITH SWITCHED NEUTRAL

### 120 VAC without Switched Neutral

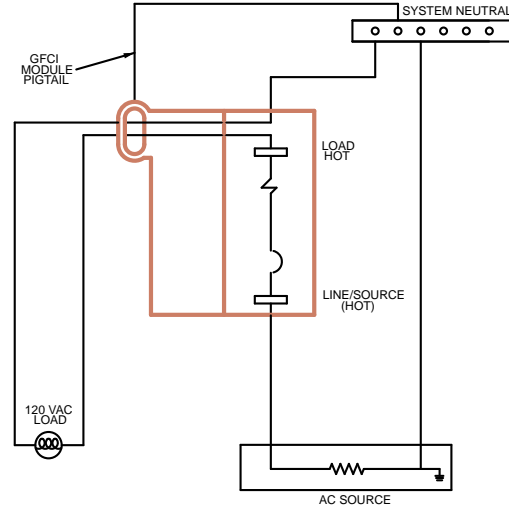

120 VAC WITHOUT SWITCHED NEUTRAL

### 120/240 VAC with Switched Neutral

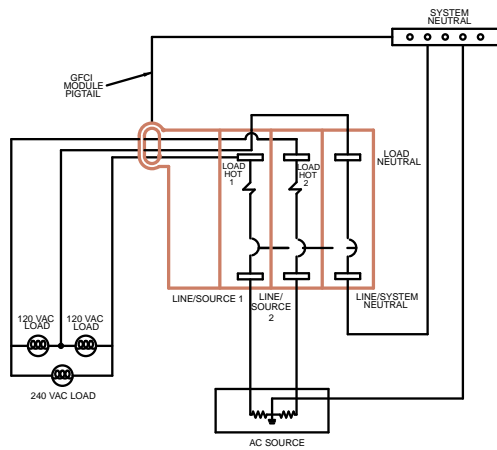

120 VAC WITH SWITCHED NEUTRAL

### 120/240 VAC without Switched Neutral

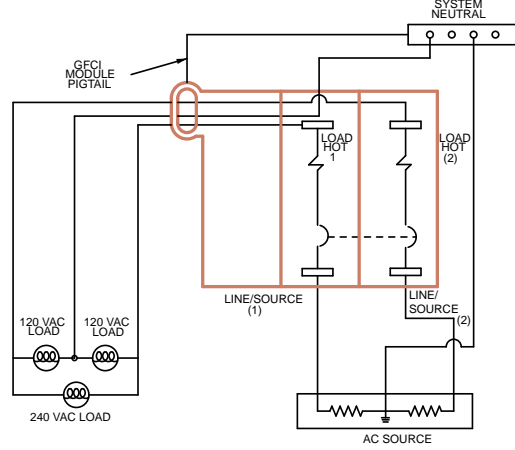

120 VAC WITHOUT SWITCHED NEUTRAL



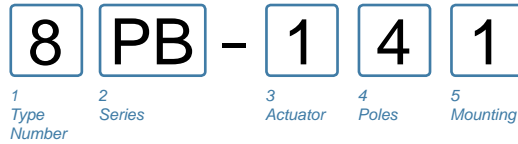

**1 TYPE NUMBER**  
8 Circuit Breaker Assembly

**2 SERIES**  
PB

**3 ACTUATOR TYPE**  
1 Handle, one per pole  
2 Handle, one per multipole unit  
A Rocker<sup>2</sup>

**4 POLES PER UNIT - INCLUDING ELECTRONIC MODULE**  
2 Two  
3 Three  
4 Four

**5 MOUNTING SCREWS / PLATE MATERIAL<sup>1</sup>**  
1 6-32 Thread Phillips Head  
2 M-3 Thread Phillips Head  
3 6-32 Thread Slotted Head  
4 M-3 Thread Slotted Head  
5 6-32 Thread Phillips Head with Stainless Steel Plate  
6 M-3 Thread Phillips Head with Stainless Steel Plate  
7 6-32 Thread Slotted Head with Stainless Steel Plate  
8 M-3 Thread Slotted Head with Stainless Steel Plate

Notes:  
1 Screws supplied to accommodate mounting panel thickness of 1/8" ± 1/32". Consult Factory for additional options.  
2 Available for Flat and Curved Rocker options - No Rockerguard Bracket

### Handle Style Panel Seal

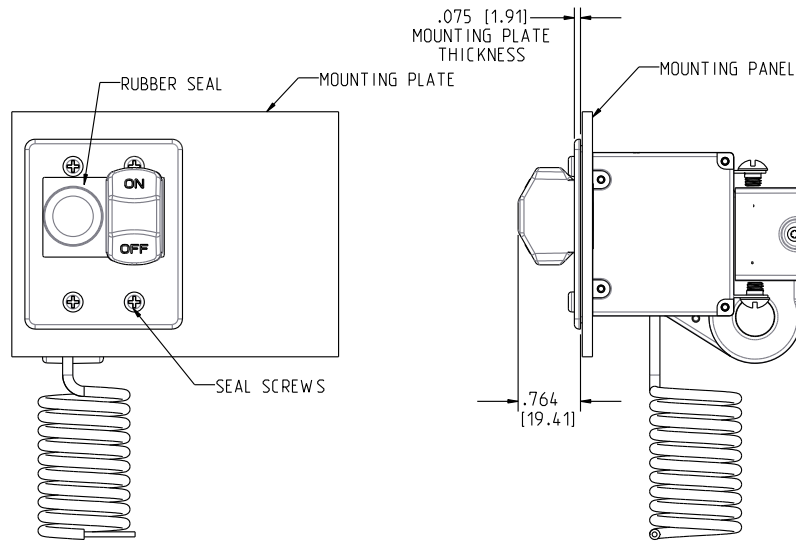

### Rocker Style Panel Seal

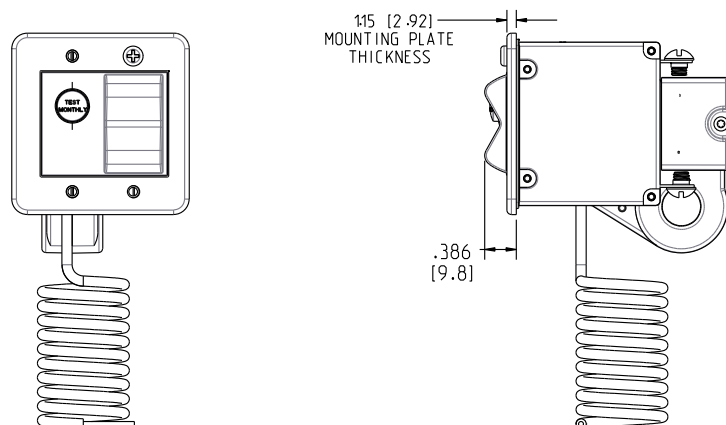

### Handle Actuator

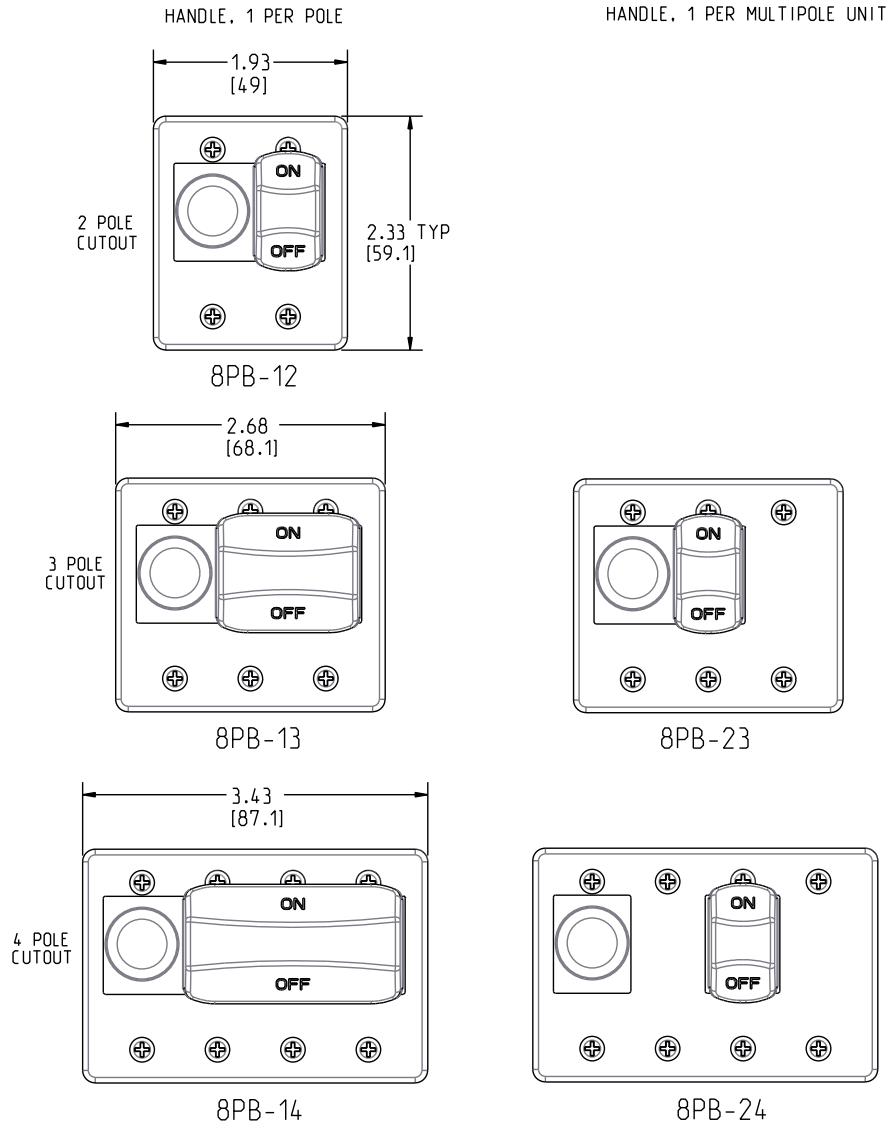

### Rocker Actuator

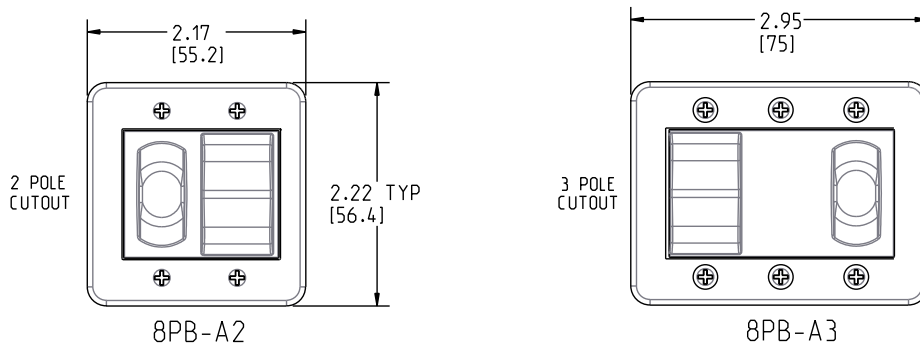

## Time Delay Curves

### Instantaneous

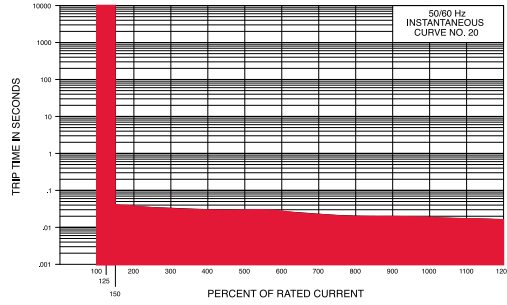

### Medium

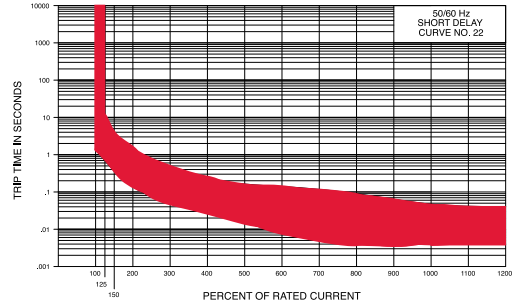

### Short

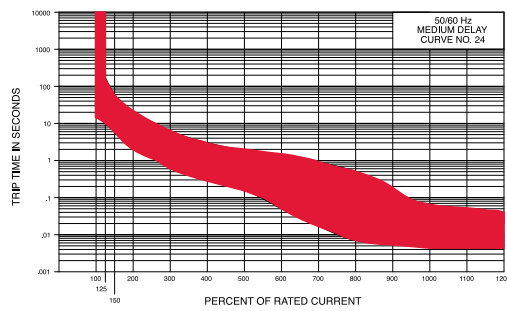

### Long

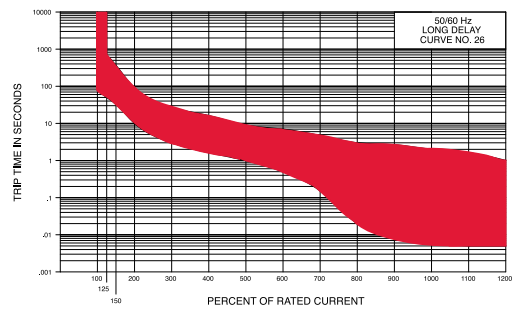

# PC-Series

## GFCI/ELCI & PANEL SEAL

The PC-Series, AC Residual Current Circuit Breaker with Overcurrent Protection (RCBO), combines the ground fault protection of a GFCI with the familiar overcurrent tripping characteristics of a normal circuit breaker. The PC-Series utilizes the hydraulic-magnetic principle which provides precise operation and performance even when exposed to extremely hot and/or cold application environments.



### Resources:

Download 3D CAD Files

[IGS >](#)

[STP >](#)

### Product Highlights:

- Overload, short circuit and ground fault protection in a single package
- Handle style actuators and rocker style “acuguard”
- Wiping Contacts - Mechanical linkage with two-step actuation - cleans contacts, provides high, positive contact pressure & longer contact life
- A trip-free mechanism, a safety feature which makes it impossible to manually hold the contacts closed during overload or fault conditions.
- A common trip linkage between poles ensures that an overload in one pole will trip all adjacent poles.
- Front panel mounting
- Integral push-to-test button
- Two integrated LED indicators show if a breaker is closed w/ Line Voltage present, or has opened due to leakage current, opened due to overcurrent, or closed w/ no Line Voltage present.
- Optional Hot/Neutral reversal detection and protection

### Benefits:

- Increases safety around boats, marinas and generators
- Protects against electrical shock hazards in areas near water
- Protects against defects in the wires & conductors
- Reduces fire and shock hazards from defects in permanently installed appliances such as water heaters, battery chargers, lighting fixtures, etc.
- Detects low level ground faults, which do not trip ordinary circuit breakers, that can lead to fires and shock hazards for boating occupants

# PC-Series Switch

## DESIGN FEATURES

### MOUNTING PLATE

Available in stainless steel or zinc chromate plated carbon steel



### OPTIONAL SEAL

IP66/67 panel seals provide ideal protection against salt spray, ozone, dust, water and most acids



### LEDs

Two separate lights that indicate power and ground fault leakage

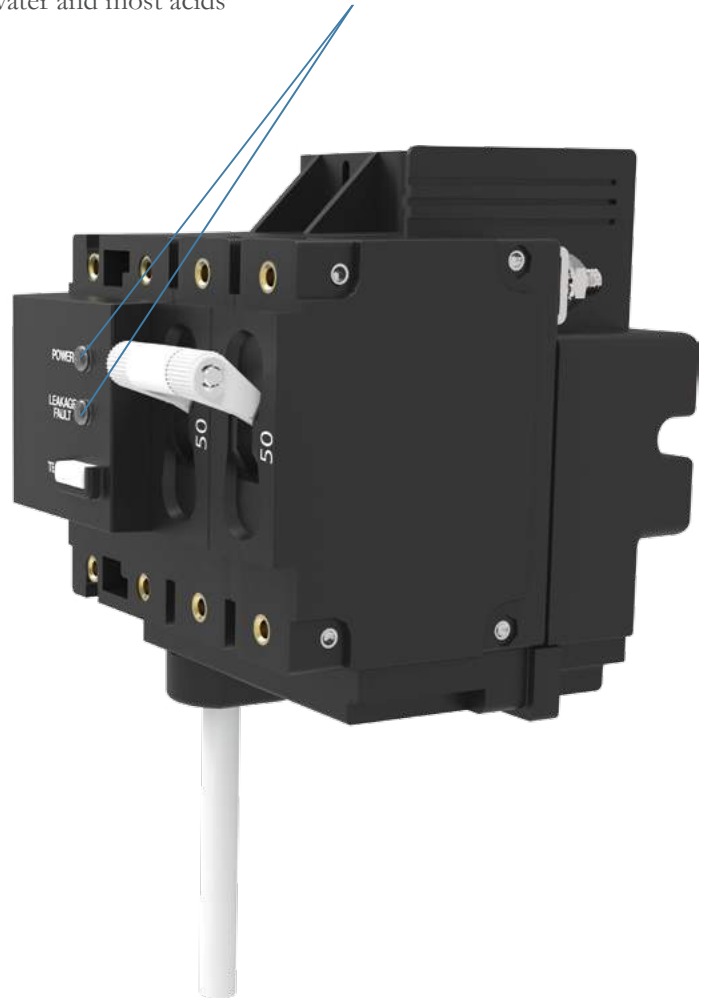

\*Manufacturer reserves the right to change product specification without prior notice.

## Electrical Tables

**Table A:** UL Listed & CSA Certified configurations as a Ground Fault Circuit Interruptor

PC-SERIES TABLE A: UL Listed / CSA 22.2 No. 144.1 Configurations as a Ground Fault Circuit Interruptor							
Circuit Configuration	Voltage			Current Rating (Amps)	Short Circuit Capacity (Amps)	Ground Fault Trip Level (Milliamps)	Notes
	Max Rating	Frequency	Phase				
Series	120	50 / 60	1	1 - 50	5000	6	1 or 2 Poles. One pole of a two pole unit must be Neutral
	120 / 240	50 / 60	1	1 - 50	5000	6	1 or 2 Poles. One pole of a three pole unit must be Neutral

**Table B:** UL Recognized as an Earth Leakage Circuit Interruptor - 120 and 120/240V

PC-SERIES TABLE B: UL Recognized Configurations as an Earth Leakage Circuit Interruptor							
Circuit Configuration	Voltage			Current Rating (Amps)	Short Circuit Capacity (Amps)	Ground Fault Trip Level (Milliamps)	Notes
	Max Rating	Frequency	Phase				
Series	120	50 / 60	1	1 - 50	5000	30	1 or 2 Poles. One pole of a two pole unit must be Neutral
	120 / 240	50 / 60	1	1 - 50	5000	30	1 or 2 Poles. One pole of a three pole unit must be Neutral
Series Ignition Protection	120	50 / 60	1	1 - 50	3000	30	1 or 2 Poles. One pole of a two pole unit must be Neutral
	120 / 240	50 / 60	1	1 - 50	5000	30	1 or 2 Poles. One pole of a three pole unit must be Neutral

**Table C:** UL Recognized as an Earth Leakage Circuit Interruptor - 240V

PC-SERIES TABLE C: UL Recognized Configurations as an Earth Leakage Circuit Interruptor - 240V							
Circuit Configuration	Voltage			Current Rating (Amps)	Short Circuit Capacity (Amps)	Ground Fault Trip Level (Milliamps)	Notes
	Max Rating	Frequency	Phase				
Series	240	50 / 60	1	1 - 30	5000	30	2 or 3 Poles. One pole of a two pole unit must be Neutral. Suffix 11
Series Ignition Protection	240	50 / 60	1	1 - 50	5000	30	2 or 3 Poles. One pole of a three pole unit must be Neutral. Suffix 12

## Agency Certifications

UL Standard 489	Circuit Breakers, Molded Case, (Guide DIVQ, File E129899)
UL Standard 1077	Supplementary Protectors
CSA 22.2 No. 144.1	Class A Ground Fault Circuit Interrupters
UL Standard 1053	Ground Fault Sensing and Relaying Equipment
UL Standard 1500	Ignition Protection

### Electrical

Current Ratings 1 - 50 Amps maximum  
 Voltage Rating 120VAC, 120/240VAC, 240VAC  
 Current Trip Level 30mA & 6mA  
 Current Trip Time For 30mA leakage trip:  
 ≤ 22.2mA, shall not trip  
 30mA, shall trip within .10 seconds  
 The above complies with & ABYC E11. For 6mA leakage trip: ≤25ms  
 Operating Frequency 50/60 Hz for 30mA leakage trip  
 60 Hz for 6mA leakage trip  
 Interrupt Capacity 5,000 Amps  
 Impedance

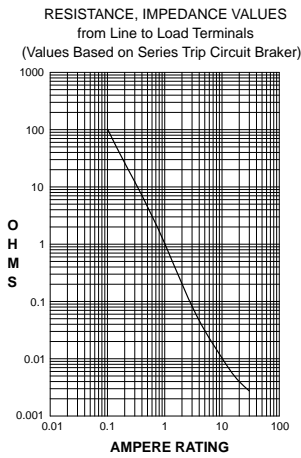

CURRENT (AMPS)	TOLERANCE (%)
0.10 - 5.0	± 15
5.10 - 20.0	± 25
20.10 - 50.0	± 35

### Innovative Features

Indicator Two integrated LEDs, Red & Green  
 ♦ Green LED On, Red LED Off  
 Line Voltage is present, the breaker is closed, and the device is protecting the circuits against over current and leakage current.  
 ♦ Green LED Off, Red LED On  
 The device has detected leakage current and has opened the circuit breaker.  
 ♦ Green LED Flashing, Red LED Off  
 The circuit breaker has opened due to over current or has been turned off manually  
 ♦ Green LED Off, Red LED Off  
 Line Voltage is not present  
 ♦ Green LED Flashing, Red LED Off, Amber LED ON  
 Indicates Hot & Neutral are reversed and the circuit breaker is open  
 Neutral Protection When neutral is grounded on load side of circuit  
 Test Button Located on Ground Fault Module

### Mechanical

Endurance 10,000 ON-OFF operations @ 6 per minute; with rated Current & Voltage.  
 Trip Free Trips on short circuit, overload or leakage to ground, even when actuator is forcibly held in the "On" position

### Physical

Number of Poles (Breakers only) 1-pole (1 Circuit Breaker + 1 GFCI Sensor Module), 120V  
 2-pole (2 Circuit Breakers + 1 GFCI Sensor Module), 120/240V or 120V with Neutral Break. 240VAC two pole. 3-pole 120/240V with Neutral Break (Sensor module has 2 pole width) Circuit Breaker Line Side: #10-32, Threaded stud. GFCI Sensor Module Load Side: #10-32 threaded stud. Neutral pigtail. Front Panel, #6-32 and M3 threaded inserts.  
 Termination  
 Mounting  
 Actuator Handle, Flat Rocker, Curved Rocker (with or without rocker guard), Push-to-Reset Rocker

### Environmental

Designed and tested in accordance with requirements of specification MIL-PRF- 55629 and MIL-STD-202G as follows:  
 Shock Withstands 100 G, 6ms, sawtooth at rated current per Method 213, Test Condition "I".  
 Vibration Withstands 0.06" excursion from 10-55 Hz, and 10 G 55-500 Hz, a rated current per Method 204C, Test Condition A. Instantaneous & ultrashort curves tested at 90% of rated current.  
 Moisture Resistance 93% RH at 30°C for 168 Hours.  
 Operating Temperature -35°C to +66°C  
 Corrosion Humidity: 30±2°C, 70±2% relative humidity  
 Mixed Flowing Gases: 100 ppb H2S, 20 ppb Cl2, 200±50 ppb NO2

**PC** - **B** - **B** - **A** - **24** - **620** - **1** - **B** - **A** - **A** - **10**

1 Series      2 System Voltage/Poles      3 Circuit      4 Actuator      5 Frequency & Delay      6 Current Rating      7 Terminal      8 Actuator Color      9 Mounting/Barriers      10 Trip Level      11 Agency Approval

**1 SERIES**  
**PC**

**2 SYSTEM VOLTAGE / POLES**

- A** 120 VAC single phase, 1 pole
- B** 120/240 VAC single phase, 2 pole
- C** 120/240 VAC single phase with switched neutral, 3 pole
- D** 120 VAC single phase with switched neutral, 2 pole
- E** 120 VAC single phase with reversed polarity indicator, 2 pole
- F** 120/240 VAC single phase with reversed polarity indicator, 3 pole
- G** 240 VAC single phase, 2 pole

**3 CIRCUIT**

- B** Series Trip (Current)

**4 ACTUATOR**

**Handle**

- A** 1 per breaker pole
- B** 1 per unit

**Two Color Curved Visi-Rocker**

- C** Indicate ON, vertical legend
- D** Indicate ON, horizontal legend
- F** Indicate OFF, vertical legend
- G** Indicate OFF, horizontal legend

- J** Vertical legend
- K** Horizontal legend

**Two Color Curved Visi-Rocker Push-to-Reset**

- N** Indicate OFF, Vertical legend
- O** Indicate OFF, Horizontal legend

**Single Color Curved Rocker Push-to-Reset**

- 5** Indicate OFF, vertical legend
- 6** Indicate OFF, horizontal legend

**Two Color Flat Visi-Rocker Push-to-Reset**

- 7** Vertical legend
- 8** Horizontal legend

- 1** Indicate ON, vertical legend
- 2** Indicate OFF, horizontal legend

- 3** Vertical legend
- 4** Horizontal legend

**Single Color Curved Rocker Push-to-Reset**

- R** Vertical legend
- U** Horizontal legend

**Two Color Flat Visi-Rocker**

- 1** Indicate ON, vertical legend
- 2** Indicate OFF, horizontal legend

- 3** Vertical legend
- 4** Horizontal legend

**Single Color Flat Rocker**

- 5** Indicate OFF, vertical legend
- 6** Indicate OFF, horizontal legend

**Two Color Flat Visi-Rocker Push-to-Reset**

- 7** Vertical legend
- 8** Horizontal legend

- 1** Indicate ON, vertical legend
- 2** Indicate OFF, horizontal legend

- 3** Vertical legend
- 4** Horizontal legend

- 5** Indicate OFF, vertical legend
- 6** Indicate OFF, horizontal legend

ROCKER STYLE DESCRIPTIONS				
INDICATE "ON"	INDICATE "OFF"	SINGLE COLOR	INDICATE "OFF"	SINGLE COLOR
CODE "1"	CODE "1", "N"	CODE "1", "R"	CODE "1", "U"	CODE "1", "U"
CODE "2"	CODE "2", "N"	CODE "2", "R"	CODE "2", "U"	CODE "2", "U"
CODE "3"	CODE "3", "N"	CODE "3", "R"	CODE "3", "U"	CODE "3", "U"
CODE "4"	CODE "4", "N"	CODE "4", "R"	CODE "4", "U"	CODE "4", "U"

**5 FREQUENCY & DELAY**

- 20** 50/60Hz Instantaneous
- 21** 50/60Hz Ultra Short
- 22** 50/60Hz Short
- 24** 50/60Hz Medium
- 26** 50/60Hz Long

**6 CURRENT RATING (AMPERES)**

CODE	AMPERES	CODE	AMPERES	CODE	AMPERES	CODE	AMPERES
410	1.000	445	4.500	610	10.000	618	18.000
512	1.250	450	5.000	710	10.500	620	20.000
415	1.500	455	5.500	611	11.000	622	22.000
517	1.750	460	6.000	711	11.500	624	24.000
420	2.000	465	6.500	612	12.000	625	25.000
522	2.250	470	7.000	712	12.500	630	30.000
425	2.500	475	7.500	613	13.000	635	35.000
527	2.750	480	8.000	614	14.000	640	40.000
430	3.000	485	8.500	615	15.000	650	50.000
435	3.500	490	9.000	616	16.000		
440	4.000	495	9.500	617	17.000		

**7 TERMINAL**

- 1** Stud, 10-32 threaded

**8 ACTUATOR COLOR & LEGEND**

**Handle**

Actuator Color	I-O	ON-OFF	Dual	Rocker Single	Actuator Color Visi-Rocker
White	A	B	1	Black	White
Black	C	D	2	White	N/A
Red	F	G	3	White	Red
Green	H	J	4	White	Green
Blue	K	L	5	White	Blue
Yellow	M	N	6	Black	Yellow
Gray	P	Q	7	Black	Gray
Orange	R	S	8	Black	Orange

**9 MOUNTING/BARRIERS**

Handle	MOUNTING STYLE	BARRIERS
<b>A</b>	6-32 X 0.195 inches Threaded Insert, 2 per pole	
<b>B</b>	ISO M3 x 5mm Rockerguard Bezel	yes
<b>C</b>	6-32 X 0.195 inches Threaded Insert, 2 per pole	yes
<b>D</b>	ISO M3 x 5mm Standard Bezel with Recessed Off-Side Flat Rocker	yes
<b>E</b>	6-32 X 0.195 inches Threaded Insert, 2 per pole	yes
<b>F</b>	ISO M3 x 5mm Push-to-Reset Bezel	yes
<b>G</b>	6-32 X 0.195 inches Threaded Insert, 2 per pole	
<b>H</b>	ISO M3 x 5mm	yes

**10 LEAKAGE CURRENT TRIP LEVEL - MAX. TRIP CURRENT**

- A** 6 MA (CLASS A GFCI)
- E** 30 MA (ELC) 1,2

**11 AGENCY APPROVAL**

- AA** without Approvals
- 10** CSA certified
- 11** UL 1053 1,2
- 12** UL 1053 & UL 1500 1,2

Notes:

- 1 This device meets the requirements of ABCY E11.
- 2 30mA per UL1053, available with agency approval codes 11 & 12.



INDICATE OFF / SINGLE COLOR  
ROCKER ACTUATOR

PCA  
120 VAC  
VERSION

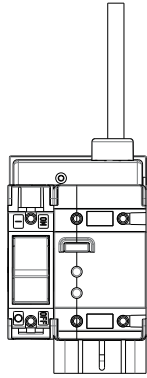

HANDLE / INDICATE ON  
ROCKER ACTUATOR

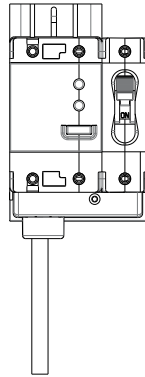

TERMINAL  
LOCATIONS

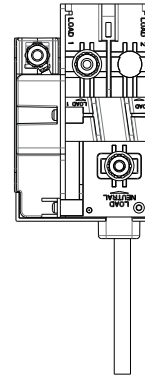

PCB  
120/240 VAC  
VERSION

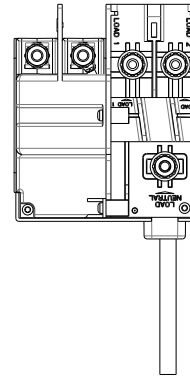
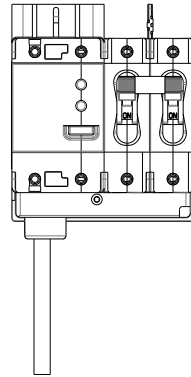
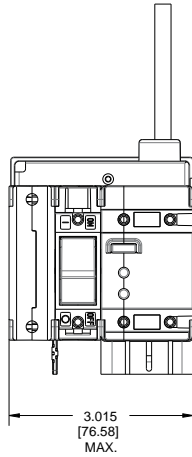

PCC  
120/240 VAC  
VERSION  
W/ NEUTRAL BREAK

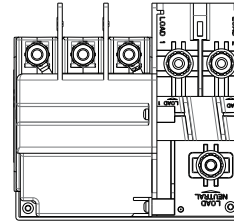
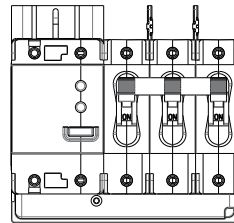
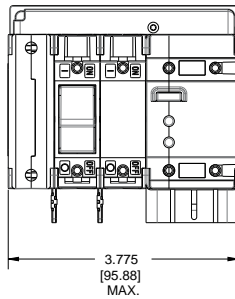

PCD  
120 VAC  
VERSION  
W/NEUTRAL BREAK

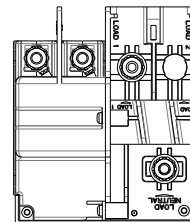
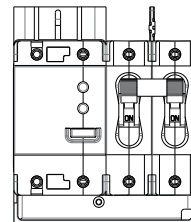
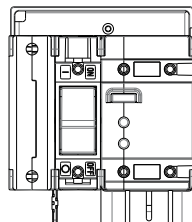

INDICATE OFF / SINGLE COLOR  
ROCKER ACTUATOR

HANDLE / INDICATE ON  
ROCKER ACTUATOR

TERMINAL  
LOCATIONS

PCE  
120 VAC VERSION  
W/ REVERSE POLARITY  
INDICATOR

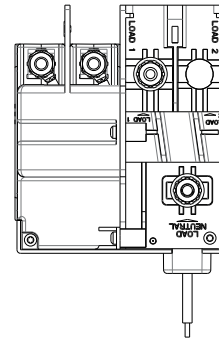
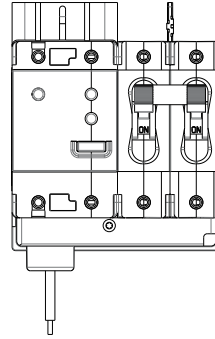
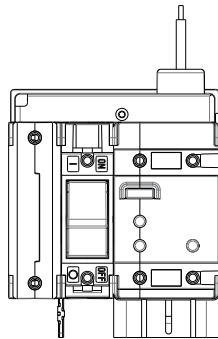

PCF  
120/240 VAC VERSION  
W/ REVERSE POLARITY  
INDICATOR

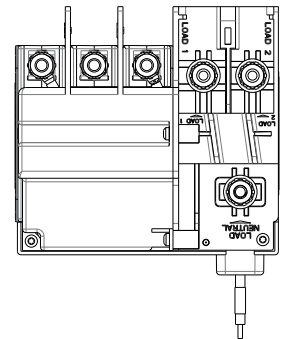
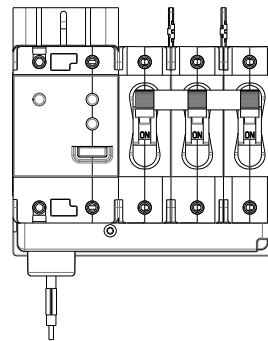
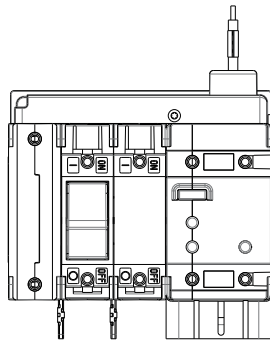

NOTE: NEUTRAL & GROUND PIGTAIL WIRES - SUPPLIED 12" LONG MIN. (CIRCUIT CODES A,B,E & F)

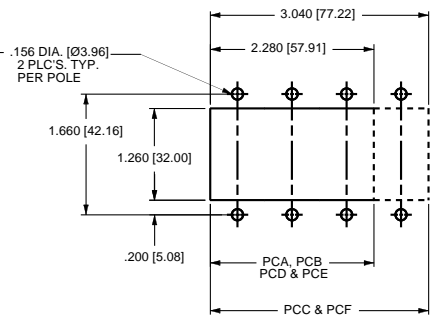
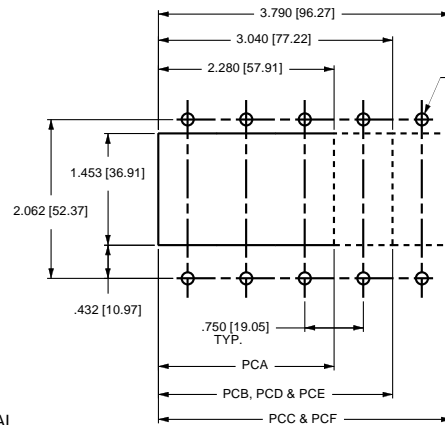
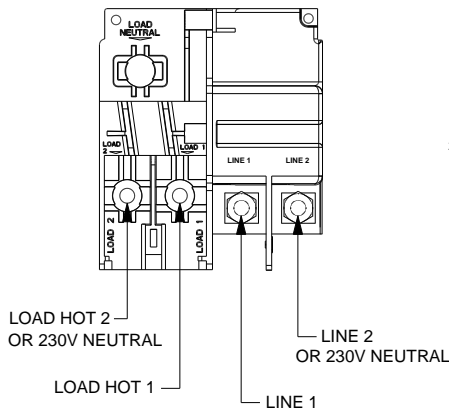

HANDLE ACTUATOR

ROCKER ACTUATOR

PANEL CUTOUT DETAIL  
TOLERANCES ±.005 [ .12]

# PC-Series Circuit Breaker - Dimensional Specifications

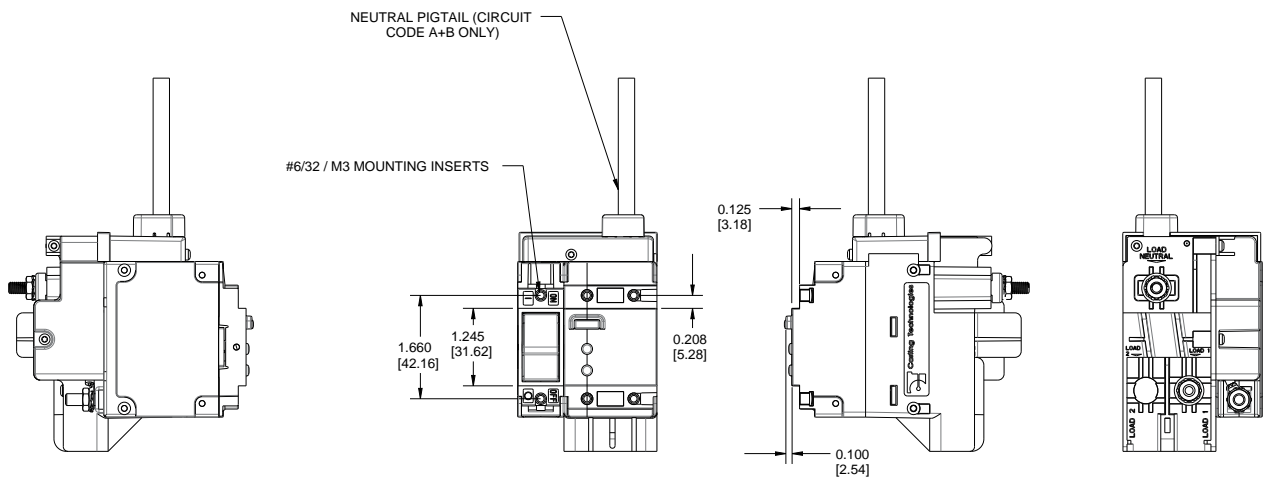
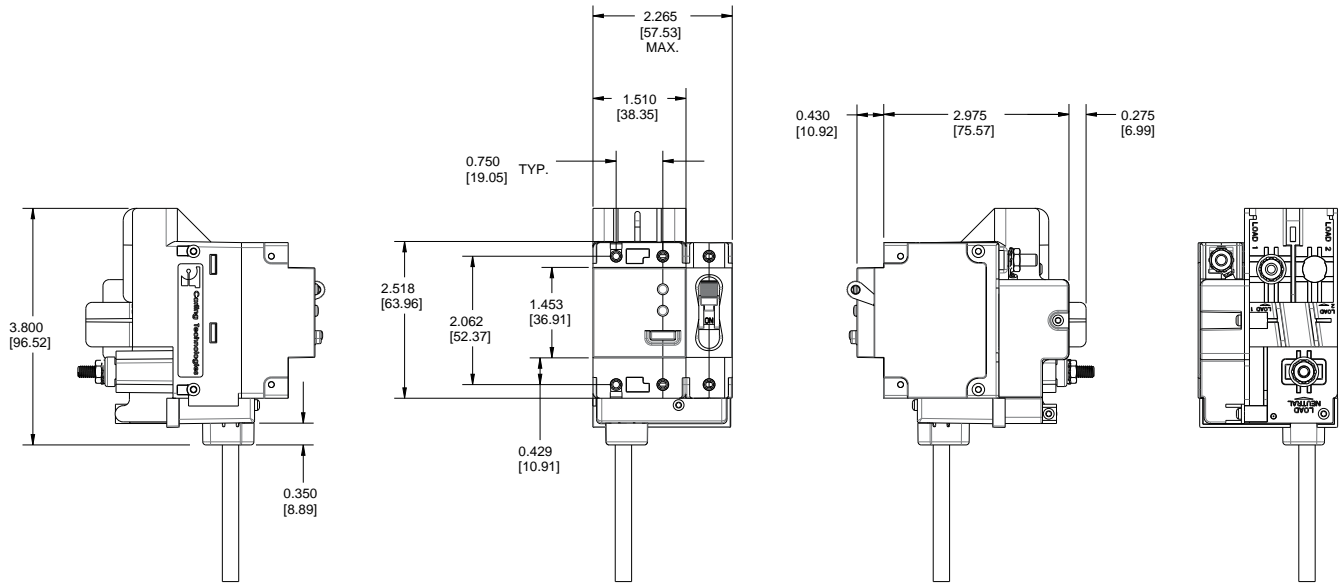

Notes:  
For additional circuit breaker dimensions, reference the C-Series Breakers in the Carling Circuit Protection catalog

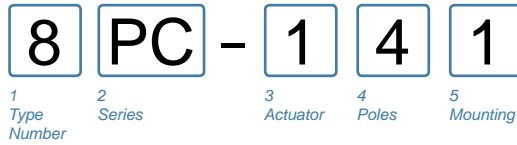

**1 TYPE NUMBER**  
 8 Circuit Breaker Assembly

**2 SERIES**  
 PC

**3 ACTUATOR TYPE**  
 1 Handle, one per pole  
 2 Handle, one per multipole unit  
 A Rocker <sup>2</sup>

**4 POLES PER UNIT - INCLUDING ELECTRONIC MODULE**  
 3 Three  
 4 Four  
 5 Five

**5 MOUNTING SCREWS / PLATE MATERIAL <sup>1</sup>**  
 1 6-32 Thread Phillips Head  
 2 M-3 Thread Phillips Head  
 3 6-32 Thread Slotted Head  
 4 M-3 Thread Slotted Head  
 5 6-32 Thread Phillips Head w/ Stainless Steel Plate  
 6 M-3 Thread Phillips Head w/ Stainless Steel Plate  
 7 6-32 Thread Slotted Head w/ Stainless Steel Plate  
 8 M-3 Thread Slotted Head w/ Stainless Steel Plate

Notes:  
 1 Screws supplied to accommodate mounting panel thickness of 1/8" ± 1/32". Consult Factory for additional options  
 2 Available for Flat and Curved Rocker options - No Rockerguard Bracket

**Handle Style Panel Seal**

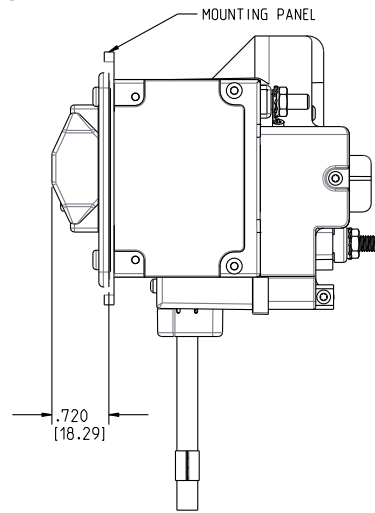
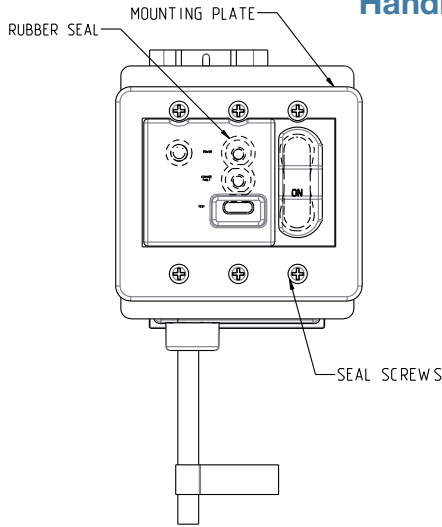

**Rocker Style Panel Seal**

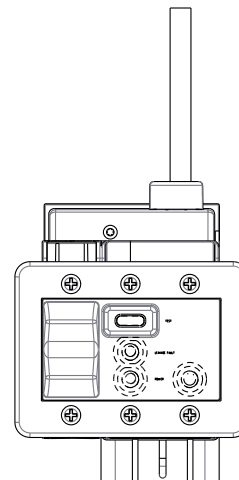
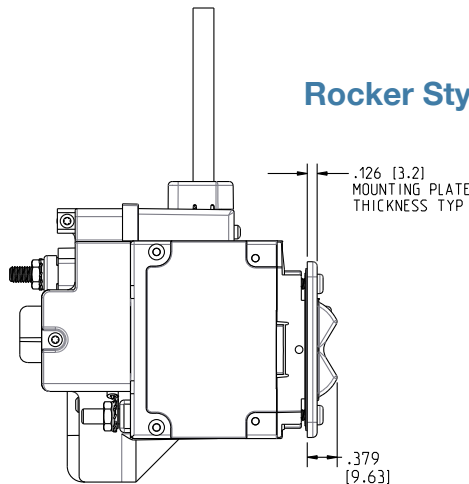

### Handle Actuator

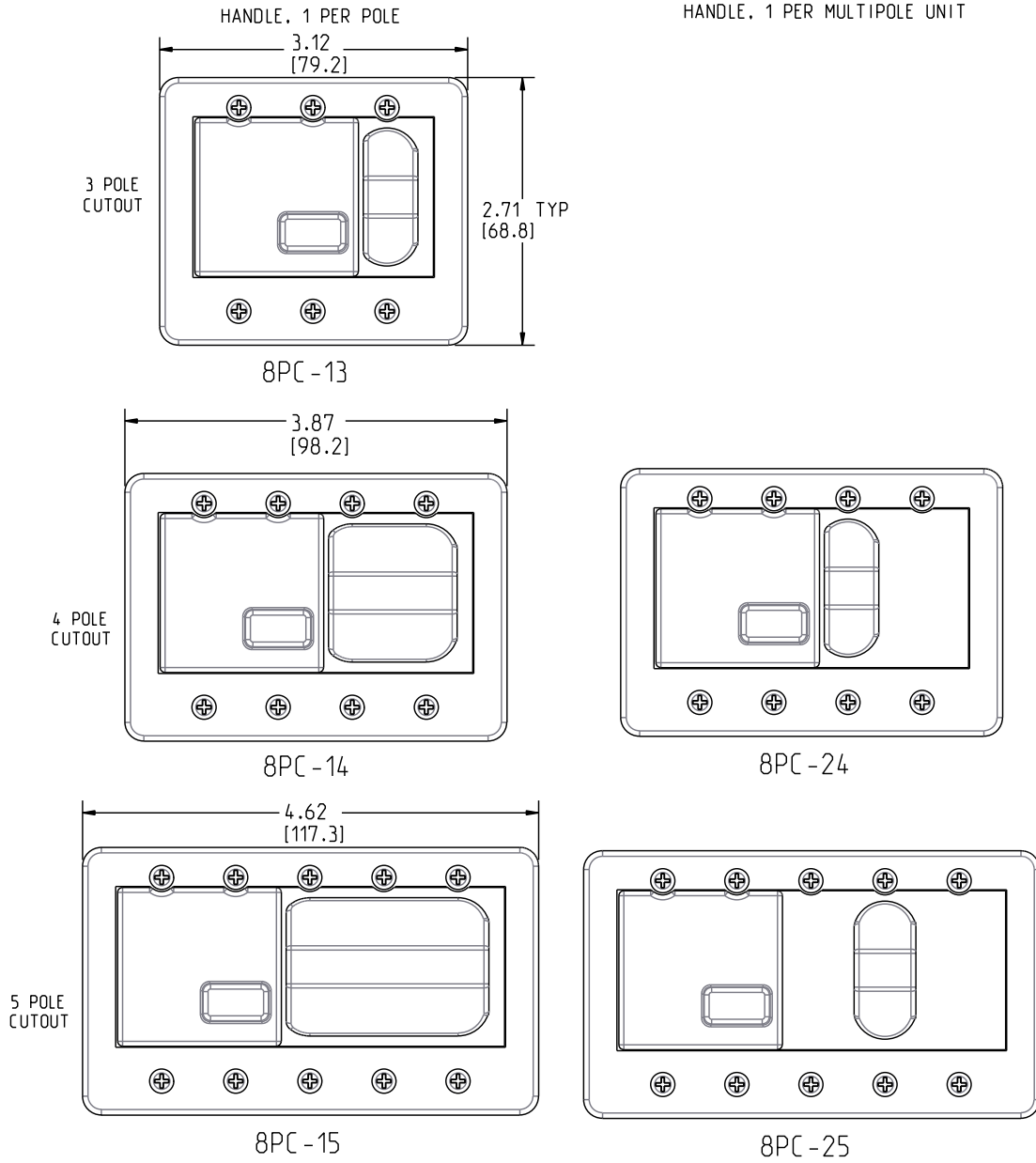

### Rocker Actuator

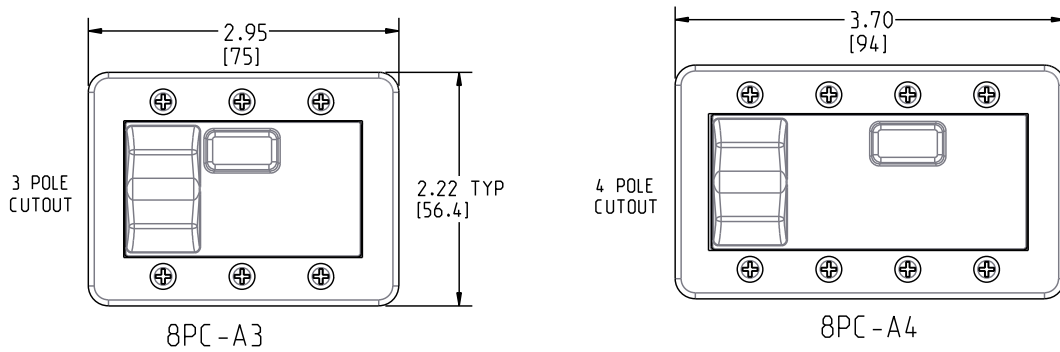

### Time Delay Curves Instantaneous

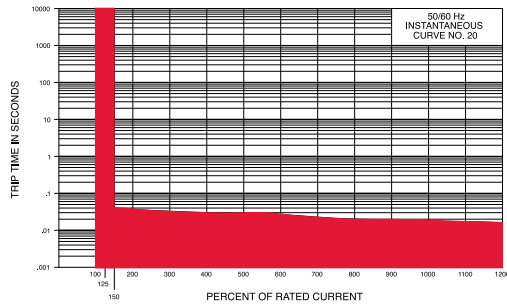

### Medium

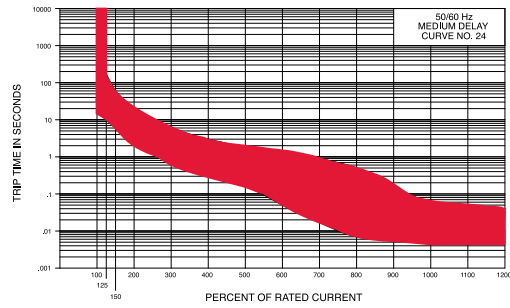

### Ultra Short

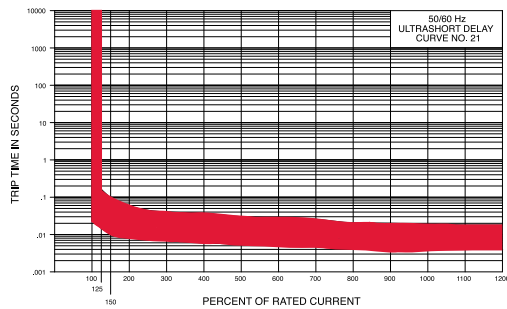

### Long

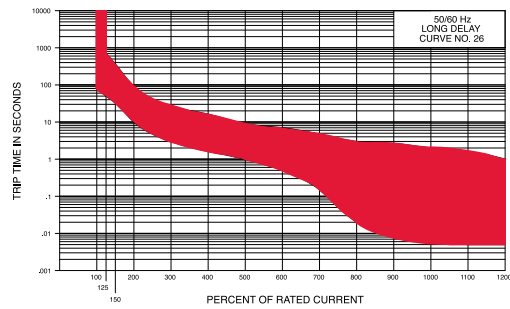

### Short

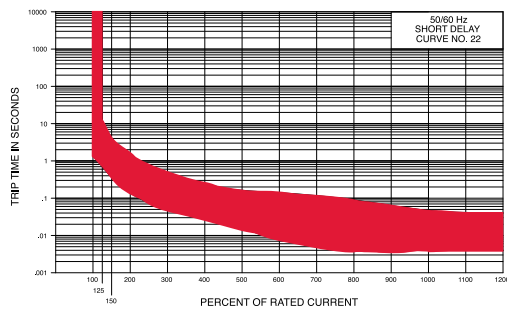

Time Delay Values									
Percent of Rated Current									
Delay	100%	125%	150%	200%	400%	600%	800%	1000%	1200%
<b>20</b>	No Trip	May Trip	.040 MAX	.035 MAX	.030 MAX	.025 MAX	.020 MAX	.017 MAX	.015 MAX
<b>21</b>	No Trip	.014 - .150	.011 - .095	.008 - .055	.006 - .035	.005 - .027	.005 - .021	.004 - .018	.004 - .017
<b>22</b>	No Trip	.700 - 12.0	.350 - 4.00	.130 - 1.30	.027 - .220	.008 - .130	.004 - .090	.004 - .045	.004 - .040
<b>24</b>	No Trip	10.0 - 160	6.00 - 60.0	2.20 - 20.0	.300 - 3.00	.050 - 1.30	.007 - .500	.005 - .060	.005 - .040
<b>26</b>	No Trip	50.0 - 700	32.0 - 350	10.0 - 90.0	1.50 - 15.0	.500 - 7.00	.020 - 3.00	.006 - 2.00	.005 - 1.00

**Notes:**

Other time delay values available, consult factory.

Delay Curves 21,22,24,26: Breakers to hold 100% and must trip at 125% of rated current and greater within the time limit shown in this curve.

Delay Curve 20: Breakers to hold 100% and must trip at 150% of rated current and greater within the time limit shown in this curve.





All Curves: Curve data shown represents breaker response at ambient temperature of 77°F (25°C) with no preloading. Breakers are mounted in standard wall-mount position.





The minimum inrush pulse tolerance handling capability is 12 times the rated current. These values are based on a 60 Hz 1/2 cycle, 8.33 ms pulse.

LEGEND		LEGEND CODE		
SYMBOL	NAME (SYMBOL MEANING)	BODY	LENS	
			NEGATIVE <sup>1</sup>	POSITIVE
	RUNNING LIGHTS (UNDER POWER)	AA	NA	MA
	LIGHT	AB	NB	MB
	MASTER LIGHT SWITCH	AC	NC	MC
	HORN	AD	ND	MD
	PROPULSION SYSTEM TRIM TRIMMING OPERATION	AE	NE	ME
	VENTILATION FAN OR BLOWER	AF	NF	MF
	WINDSHIELD WASHER	AG	NG	MG
	WINDSHIELD WIPER	AH	NH	MH
	BILGE PUMP	AJ	NJ	MJ
	BILGE BLOWER	AK	NK	MK
	POTABLE WATER PRESSURE	AL	NL	ML
	ENGINE START	AM	ED	MM
	ENGINE STOP	AN	EE	MN
	DRIVE TILT TILT OPERATION	30		31
	EMERGENCY START	32		33
	UP/DOWN LIFT	34		
	TRIM TAB TRIMMING OPERATION	35		36

LEGEND		LEGEND CODE		
SYMBOL	NAME (SYMBOL MEANING)	BODY	LENS	
			NEGATIVE <sup>1</sup>	POSITIVE
	ANCHOR LIGHT	37		38
	ANCHOR	39		40
	WATER FLUSHING TAP FOR OUTBOARDS	41		42
	HIGH BEAM	43	44	45
	LOW / DIPPED BEAM	46	47	48
	SIDE MARKER LIGHT	DG	49	DF
	INTERIOR LIGHT	50	51	52
	WORK LIGHT	53	54	55
	WORK LAMP	56	57	58
	LOADING FLOOR LAMP	CW	59	CY
	ON -WIPER- INT DELAY	60		
	ROTARY BEACON	61	62	63
	LAMP TEST	DK	64	DL
	WINDSHIELD WIPER/WASHER	65	66	67
	HAZARD WARNING	68	69	70
	WARM AIR BLOWER	71	72	73
	HORN REAR	AX	74	Y4

Notes:  
 1 Negative legends not available on L, LD, LW, and N-Series.  
 2 Many symbols are SAE (J1362), ANSI and ISO approved symbols. Consult factory for custom symbols/icons.  
 3 Use "body" legend codes for laser etched image identification.

LEGEND		LEGEND CODE		
SYMBOL	NAME <small>(SYMBOL MEANING)</small>	BODY	LENS	
			NEGATIVE <sup>1</sup>	POSITIVE
	REAR FOG LAMP	75	76	77
	DIFFERENTIAL LOCK	78	79	80
	ALL WHEEL DRIVE	81	82	83
	DIRECTION INDICATOR	84	85	86
ENG HATCH		87		88
HORN		89		90
BLOWER		91		92
DEPTH		93		94
BILGE PUMP		95		96
NAV LTS		97		98
COURT LTS		99		1A
PANEL LTS		1B		1C
ANCH LTS		1D		1E
TRIM TAB		1F		1G
WATER PUMP		1H		1J
WIPER		1K		1L
BILGE		1M		

LEGEND		LEGEND CODE		
SYMBOL	NAME <small>(SYMBOL MEANING)</small>	BODY	LENS	
			NEGATIVE <sup>1</sup>	POSITIVE
ENG COMP		1N		1P
ACC		1R	1S	1T
NAV ANC		1U		1V
WNDLS UP/DN		1W		1Y
NAV ANCH LTS		1Z		2A
WNDLS ON/OFF		2B		2C
DOCKING LTS		2D		2E
	MUSIC	2F		2G
	BATTERY	2H	FM	2J
	LEVER UP/DOWN	2K		
	ENG PREHEAT	2M	EA	2N
UP		2P		2R
ANTENNA		2S		
DOWN		2T		
PRESS		2U		
AUX START		2V		2W
	GAS	2Y	EB	2Z

Notes:  
 1 Negative legends not available on L, LD, LW, and N-Series.  
 2 Many symbols are SAE (J1362), ANSI and ISO approved symbols. Consult factory for custom symbols/icons.  
 3 Use "body" legend codes for laser etched image identification.















LEGEND		LEGEND CODE		
SYMBOL	NAME (SYMBOL MEANING)	BODY	LENS	
			NEGATIVE <sup>1</sup>	POSITIVE
	RIDE CONTROL	3A	EN	3B
	KICK OUT	3C		3D
	BEACON	3E	EP	3F
	SLOW	3G		3H
	CHECK	3J	DJ	3K
	A/C	3L		3M
	REAR DEFOGGER	3N	3P	3R
	FORK LIFT	3S	ER	3T
	ENG PREHEAT	3U		3V
	REAR WINDOW WIPER	AY	3Y	Y5
REAR				EC
	EXCAVATOR BACKHOE BOOM SHIFT	4B		4C
	UNLOCK	4D		4E
	TRANSMISSION LOCK	4F		4G
	FORK LIFT DOWN / UP	4H		

LEGEND		LEGEND CODE		
SYMBOL	NAME (SYMBOL MEANING)	BODY	LENS	
			NEGATIVE <sup>1</sup>	POSITIVE
	DRIVER SEAT LIGHTING	4J		4K
	SIDE MARKER LAMPS	4L	4M	4N
	FOG LAMP	4P	4R	4S
	TRUNK LIGHT	4T		4U
RED		4V		4W
AMBER		4Y		
	LINE INDICATOR	5B		5C
	HANDICAP	5D	BX	5E
	STOP REQUEST	5F		5G
	WINDSCREEN HEATING & VENTILATION	5H	FP	5J
	EXTERIOR MIRROR DEFROSTER	5K		5L
	MOMENTARY LEVER	5M		5N
	SLOW	5P		5R
HIGH		5T	Y6	5U
LOW		5V	Y7	5W
PARK		5Y		5Z

Notes:

- 1 Negative legends not available on L, LD, LW, and N-Series.
- 2 Many symbols are SAE (J1362), ANSI and ISO approved symbols. Consult factory for custom symbols/icons.
- 3 Use "body" legend codes for laser etched image identification.

LEGEND		LEGEND CODE		
SYMBOL	NAME <small>(SYMBOL MEANING)</small>	BODY	LENS	
			NEGATIVE <sup>1</sup>	POSITIVE
WASHER		6C		
	SUPPLEMENTAL STEERING	6D		6E
BATT PARL		6F		6G
	DEPTH SOUNDER	6H		6J
	MUTE	6K		6L
T I M E R		6M		
M A N		6N		
LIVEWELL		6R		
	WATER TANK		6S	
	REAR WASHER/WIPER	6T	BY	6U
	FRONT DIFFERENTIAL LOCK	6V		6W
	LEVER UP/DOWN	6Y		
	BILGE PUMP#1	6Z		7A
	BILGE PUMP#2	7B		7C
	BILGE PUMP#3	7D		7E
	RIGHT STABILIZER	7F		7G
	LEFT STABILIZER	7H		7J

LEGEND		LEGEND CODE		
SYMBOL	NAME <small>(SYMBOL MEANING)</small>	BODY	LENS	
			NEGATIVE <sup>1</sup>	POSITIVE
HEAD LIGHTS		7K		EJ
CL / ID LIGHTS		7L		
CRUISE CONTROL		7M		
SET/DECEL RES/ACCEL		7N		
ENGINE BRAKE		7P		
HIGH MED LOW		7R		
POWER WINDOW		7S		
ENGINE FAN		7T		
DRIVING LIGHTS		7U		
FOG LIGHTS		7V		
TRAILER CL / ID LIGHTS		7W		
ENGINE DIAGN		7Y		
LH/RH TANK		7Z		
MIRROR DEFOG		8A		
BACKUP LIGHTS		8B		
DASH LIGHTS		8C		
CAB SLEEPER		8D		













Notes:











- 1 Negative legends not available on L, LD, LW, and N-Series.
- 2 Many symbols are SAE (J1362), ANSI and ISO approved symbols. Consult factory for custom symbols/icons.
- 3 Use "body" legend codes for laser etched image identification.

LEGEND		LEGEND CODE		
SYMBOL	NAME (SYMBOL MEANING)	BODY	LENS	
			NEGATIVE <sup>1</sup>	POSITIVE
	SLEEPER START	8E		
	HIGH LOW	8F		
	CRUISE CONTROL	8G	8H	8J
	CRUISE CONTROL ADJUST	8K	8L	8M
	ENGINE BRAKE	8N	8P	8R
	HIGH/MED/LOW	8S	8T	8U
	POWER WINDOW	8V	8W	8Y
	ENGINE FAN	8Z	9A	9B
	DIAGNOSTICS	9C	9D	9E
	LH/RH TANK	9F	9G	9H
	LENS BLACKOUT		9J	
	VARIABLE	9L	9M	9N
	MIRROR ADJUST	9P	9R	9S
	SPEAKER	9T		9U
	SLEEPER START	9V	9W	9Y
	HIGH / LOW	9Z	A1	A2
	BEACON	A3		

















LEGEND		LEGEND CODE		
SYMBOL	NAME (SYMBOL MEANING)	BODY	LENS	
			NEGATIVE <sup>1</sup>	POSITIVE
	MIRROR	A4		
	MASTER SWITCH	A5		A6
	RABBIT (FAST)	A7		A8
	RETARDER	A9		B1
	EXHAUST BRAKE	B2	BZ	B3
	TANDEM AXLE	B4		B5
	AIR TANK	B6		B7
	DRAIN	B8		
	AUTOMATIC TRANSMISSION	B9	EX	C1
	LOADER BUCKET DOWN	C2		C3
	LOADER BUCKET	C4		C5
	AUTO	C6		
	NEUTRAL LOCK	C7	EF	C8
	TRANSMISSION NEUTRALIZER	C9		D1
	RUNNING / ANCHOR LIGHTS	D2		
	TRIM TAB TRIMMING OPERATION	D3		D5
	TRACTOR FORWARD	D6		D7

















Notes:  
 1 Negative legends not available on L, LD, LW, and N-Series.  
 2 Many symbols are SAE (J1362), ANSI and ISO approved symbols. Consult factory for custom symbols/icons.  
 3 Use "body" legend codes for laser etched image identification.

LEGEND		LEGEND CODE		
SYMBOL	NAME (SYMBOL MEANING)	BODY	LENS	
			NEGATIVE <sup>1</sup>	POSITIVE
	STEERING	D8	FN	D9
BATTERY PARALLEL		E1		
	MIRROR DEFROST	DD	E2	DE
	SLEEPER LIGHTS		E3	
	IDLE SPEED	FB	E4	FAFN
SLEEPER LIGHTS		E5		
IDLE SPEED		E6		
	MOWER DECK UP/DN	E7		E8
	4 / 2 WD LOCK	E9		F1
	STEERING CONTROL	F2		F3
	DRIVE TILT UP	F4		F5
	MILL MAIN	F6		F7
	MILL REVERSAL	F8		F9
	HEAD LIGHTS	G1		G2
	WORK LIGHT	G3		G4
RAISE		G5	EY	G6
LOWER		G7	Ez	G8

LEGEND		LEGEND CODE		
SYMBOL	NAME (SYMBOL MEANING)	BODY	LENS	
			NEGATIVE <sup>1</sup>	POSITIVE
FWD		G9		H1
REV		H2		H3
	BROOM	H4		H5
	SANDER	H6		H7
KNEEL		H8		
	CHIME MUTE	DY	H9	DZ
R. DOOR		J1		J2
F. DOOR		J3		J4
AUX BATT		J5		J6
	SWING MAIN	J7		J8
	ACTIVE SWING	J9		K1
	CENTERING	K2		K3
	REAR OPERATION AUTO-LIFT RELEASE	K4		K5
		K6		K7
	ARROW		K8	
	FRONT WINDOW DEFROST	K9		L1
	REAR WINDOW DEFROST	L2		L3

Notes:  
<sup>1</sup> Negative legends not available on L, LD, LW, and N-Series.  
<sup>2</sup> Many symbols are SAE (J1362), ANSI and ISO approved symbols. Consult factory for custom symbols/icons.  
<sup>3</sup> Use "body" legend codes for laser etched image identification.

LEGEND		LEGEND CODE		
SYMBOL	NAME (SYMBOL MEANING)	BODY	LENS	
			NEGATIVE <sup>1</sup>	POSITIVE
	SIDE WINDOW DEFROST	L4		L5
		L6		L7
	CRAWLER STRETCHING	L8		L9
	CRAWLER LOOSENING	M1		M2
	SEARCH LIGHT	M3		M4
	SIDE MIRROR DEFROST	M5		M6
		M7	CA	M8
	UNLOADER AUGER	M9		N1
	REVERSING	N2		N3
	DRIVING LIGHT	N4		N5
	HAZARD	N6		N7
	EXTRA PLUG	N8		N9
	GRAIN TANK LIGHT	P1		P2
	ROTOR LIGHT	P3		P4
	CHAFF SPREADER	P5		P6
	HANDLE	P7	EM	P8
	LEFT / RIGHT TABLE	P9		R1

LEGEND		LEGEND CODE		
SYMBOL	NAME (SYMBOL MEANING)	BODY	LENS	
			NEGATIVE <sup>1</sup>	POSITIVE
	LEFT SIDE KNIFE	R2		R3
	ALL MECHANISMS	R4		R5
	MONITOR MENU	R6		R7
	VERTICAL BAR	S1		S2
	THRESHING SYSTEM	S3		S4
	TABLE MOVEMENT	S5		S6
	CYLINDER SPEED	S7		S8
	COVER PLATE	S9		T1
	ENGINE STARTING AID	T2		T3
	TRACTION CONTROL SYSTEM	T4		T5
	HYDRAULIC DIVERTER VALVE	T6		T7
	LAMP TEST	T8	T9	U1
	DOCKING LIGHT	U2		U3
	ROCKSHAFT	U4		U5
	AUX	U6	EG	U7
	DOCK LIGHTS	U8		
	CTSY LIGHTS	U9		

- Notes:
- 1 Negative legends not available on L, LD, LW, and N-Series.
  - 2 Many symbols are SAE (J1362), ANSI and ISO approved symbols. Consult factory for custom symbols/icons.
  - 3 Use "body" legend codes for laser etched image identification.

LEGEND		LEGEND CODE		
SYMBOL	NAME <small>(SYMBOL MEANING)</small>	BODY	LENS	
			NEGATIVE <sup>1</sup>	POSITIVE
	TRIM	V1		
	AIR TEMP SEA	V2		
	ENGINE LIGHTS	V3		
	TRANS LIGHTS	V4		
	DEFOG	V5		
	SEAT	V6		
	UP TRAILER	V7		EH
	DEPTH FINDER	V8		
	EXHAUST	V9		
	SINK PUMP	W1		W2
	STORAGE LIGHTS	W3		
	UP HATCH DOWN	W4		
	TRAILER 3rd AXLE LIFT	W5	W6	W7
	TRAILER 3rd AXLE LIFT	W8		
	HANDLE BAR HEATER	W9		Y1
	PARKING BRAKE	Y2	DH	Y3
	ARROW (UP)	Y8	ES	Y9



















LEGEND		LEGEND CODE		
SYMBOL	NAME <small>(SYMBOL MEANING)</small>	BODY	LENS	
			NEGATIVE <sup>1</sup>	POSITIVE
	ARROW (DOWN)	Z1		Z2
	RIGHT SIDE KNIFE	Z3		Z4
	HYDRAULIC HAMMER	Z5		Z6
	HYDRA-CLAMP	Z7		Z8
	SHOVEL FLOAT	Z9		AP
	SHOVEL HORIZONTALLY	AR		AS
	HYDRAULIC HITCH	AT		AU
	LOCK	AV	BW	AW
	LIGHT	AZ		BA
	BLOWER FAST	BB		BC
	ARROW (LEFT)	BD	EU	BE
	ARROW (RIGHT)	BF	EV	BG
	HYDRAULIC FLUID	BH		BJ
	WORK LIGHTS	BK		BL
	TRACTOR WITH REAR PTO	BM		BN
	READING LIGHTS	BP		BR
	5 <sup>TH</sup> GEAR LOCKOUT	BS		BT













Notes:  
 1 Negative legends not available on L, LD, LW, and N-Series.  
 2 Many symbols are SAE (J1362), ANSI and ISO approved symbols. Consult factory for custom symbols/icons.  
 3 Use "body" legend codes for laser etched image identification.

LEGEND		LEGEND CODE		
SYMBOL	NAME <small>(SYMBOL MEANING)</small>	BODY	LENS	
			NEGATIVE <sup>1</sup>	POSITIVE
	FAILURE/ MALFUNCTION	BU		BV
COCKPIT LTS	COCKPIT LIGHTS	CB		CC
STOR LTS	STORAGE LIGHTS	CD		CE
SEAT		CF		CG
LIGHT		CH		CK
ANCHOR		CJ		CL
	POWER TAKE OFF	CR	EW	CS
STBD		CM		CN
FUEL		CP		CT
PORT		CU		CV
	SEAT BELT	CZ		DA
	ENGINE DIAGNOSTIC	DB		DC
	TRANS. OIL TEMP	DM	FG	DN
	TRANS. OIL PRESSURE	DP	FH	DR
	AIR FILTER	DS	FJ	DT
	WATER TEMP.	DU	FK	DV
	ENG. OIL PRESSURE	DW	FL	DX
	* BAR LENS LASER ETCHED	EK		

LEGEND		LEGEND CODE		
SYMBOL	NAME <small>(SYMBOL MEANING)</small>	BODY	LENS	
			NEGATIVE <sup>1</sup>	POSITIVE
	* * BAR LENS LASER ETCHED	EL		
DIM		FC		FD
BRIGHT		FE		FF
	REAR INTERAXLE WHEEL DIFF LOCK	FS		
	FRONT WHEEL DIFF LOCK	FT		
	CRAWLING	FU		
	HI/LO GEAR XFER BOX	FV		
	REAR INTERAXLE DIFF LOCK	FW		
	XFER BOX NEUTRAL	FX		
	SUNROOF CLOSE	FY		
	SUNROOF OPEN	FZ		
	BOGGIE LIFT SELECTOR/UP	GA		
	BOGGIE LIFT SELECTOR/DN	GB		
	REAR BUZZER INHIBIT	GC		
	EXTRA HIGH BEAM LAMP	GD		
	MIRROR HEAT	GE		
	ASR OFF ROAD	GF		
	REAR WHEEL DIFF LOCK	GG		

Notes:  
 1 Negative legends not available on L, LD, LW, and N-Series.  
 2 Many symbols are SAE (J1362), ANSI and ISO approved symbols. Consult factory for custom symbols/icons.  
 3 Use "body" legend codes for laser etched image identification.

LEGEND		LEGEND CODE		
SYMBOL	NAME (SYMBOL MEANING)	BODY	LENS	
			NEGATIVE <sup>1</sup>	POSITIVE
	ADR SWITCH	GH		
	EQUIP LIGHT	GJ		
	PANIC ALARM	GK		
	BEACON WARNING LIGHT	GL		
	MAIN DOOR UNLOCK	GM		
	BOGGIE RATIO CTRL	GN		
	WATER IN FUEL	GP		
	REDUCED SET BURGLAR ALARM	GR		
	PTO ADD GEAR BOX	GS		
	EBS TRAILER BRAKE	GT		
	MUDDY SITE	GU		
	PTO GEAR BOX	GV		
	MAIN DOOR LOCK	GW		
	HAZARD WARNING	GX		
	HILL START AID	GY		
	DRIVING LEVEL CTRL	GZ		
	DRIVING LEVEL CTRL/2	HA		
	REAR WORK PROJ LAMP	HB		

LEGEND		LEGEND CODE		
SYMBOL	NAME (SYMBOL MEANING)	BODY	LENS	
			NEGATIVE <sup>1</sup>	POSITIVE
OFF	OFF ENG CTRL RATING/PTO	HC		
	ON/OFF PARKING HEATER	HD		
	RED INTERIOR LIGHTING	HE		
	BYPASS/PARKING HEATER	HG		
	AIR SUSPENSION DN	HJ		
	AIR SUSPENSION UP	HK		
—	ENGINE RATING CTRL-	HL		
	AUTO/MANUAL	HM		
	MEM/RECALL	HN		
AUTO	DRIVING LEVEL CTRL/AUTO	HP		
	PERM XFER BOX DIFF LOCK	HR		
	FUNCTION LAMP	HT		
	ENGINE/XFER BOX PTO	HU		
	WINDOW LIFT	HV		
	ABS INHIBIT	HW		

Notes:  
 1 Negative legends not available on L, LD, LW, and N-Series.  
 2 Many symbols are SAE (J1362), ANSI and ISO approved symbols. Consult factory for custom symbols/icons.  
 3 Use "body" legend codes for laser etched image identification.



LEGEND		LEGEND CODE		
SYMBOL	NAME (SYMBOL MEANING)	BODY	LENS	
			NEGATIVE <sup>1</sup>	POSITIVE
	* CONTURA IV & V BAR LENS LASER ETCHED	HX		
	* * CONTURA IV & V BAR LENS LASER ETCHED	HY		
	ENGINE RATING CTRL	HZ		
ON	ON ENG CTRL RATING/PTO	JA		
+	ENGINE RATING CTRL+	JB		
	HAZARD WARNING LAMP	JC		
	ADR SWITCH	JD		
	DRIVING LEVEL CONTROL	JE		
	DRIVING LEVEL CONTROL	JF		
-	FUNCTION INDICATOR	JG		
	AUTO/MANUAL	JH		
	MIRROR HEAT LEFT DRIVING	JJ		
	PTO GEAR BOX	JK		
	ASR OFF ROAD/ TRACTION CTRL	JL		
	REAR WHEEL DIFF LOCK	JM		
	HSA/BSRA SWITCH	JN		
	EQUIPMENT LIGHTING	JP		
	MACHINE ON	JR		

LEGEND		LEGEND CODE		
SYMBOL	NAME (SYMBOL MEANING)	BODY	LENS	
			NEGATIVE <sup>1</sup>	POSITIVE
	PANIC ALARM	JS		
	BEACON WARNING LIGHT	JT		
	MV SUNROOF HATCH	JU		
	BOGGIE LIFT SELECTOR	JV		
	BOGGIE LIFT SELECTOR	JW		
	ACOUSTIC REVERSE LIGHT	JX		
	REAR WORK PROJECTOR LAMP	JY		
	PTO ON REAR ENGINE NMV	JZ		
	REAR INTER AXLE/ WHEEL DIFF LOCK	KA		
	WINDOW LIFT	KB		
	AIR SUSPENSION DOWN	KC		
	AIR SUSPENSION UP	KD		
	MAIN DOOR UNLOCK	KE		
	MAIN DOOR LOCK	KF		
MEM 	MEMORIZE/ RECALL SWITCH	KG		
2s recall 5s store 	MEMORIZE/ RECALL SWITCH	KH		
ON 	ON/OFF ENGINE RATING CTRL	KJ		
	REDUCED SET BURGLAR ALARM	KK		

Notes:  
 1 Negative legends not available on L, LD, LW, and N-Series.  
 2 Many symbols are SAE (J1362), ANSI and ISO approved symbols. Consult factory for custom symbols/icons.  
 3 Use "body" legend codes for laser etched image identification.

LEGEND		LEGEND CODE		
SYMBOL	NAME (SYMBOL MEANING)	BODY	LENS	
			NEGATIVE <sup>1</sup>	POSITIVE
	PARKING HEATER	KL		
	PTO ADD GEAR BOX	KM		
	MUDDY SITE SWITCH	KN		
	EBS TRAILER BRAKE	KP		
	+/- POUR PMT	KR		
	+/- POUR PMT	KS		
	ADR SWITCH	KT		
	ADR SWITCH	KV		
	WINCH UP	KW		
	WINCH DOWN	KX		
	CRUISE SPEED	KY		
	CRUISE RESUME	KZ		
	CRUISE SET	LA		
	MAIN SWITCH CONTROL	LB		
	ADDITIONAL WARNING	LC		
	REAR SEARCH SPOTLIGHT	LD		
	FRONT SEARCH SPOTLIGHT	LE		
	2 TONES SIREN	LF		

LEGEND		LEGEND CODE		
SYMBOL	NAME (SYMBOL MEANING)	BODY	LENS	
			NEGATIVE <sup>1</sup>	POSITIVE
	DAY/NIGHT MODE	LG		
	OFF ROAD MODE	LH		
	ROAD MODE	LJ		
	WINDOW LIFT	LK		
	AUTO NEUTRAL MV/DV	LL		
	SUNROOF CONTROL	LM		
	BEACONS WARNING LIGHTS	LN		
	REDUCE SET ALARM	LP		
	NIGHT HEATER	LR		
	WHITE DISC	LS		
	AUTO NEUTRAL RENAULT	LT		
	OFF ROAD	LU		
	FUNCTION LIGHT	LV		
ON OFF			11	
OFF ON			12	
 O O 			13	
 O O 			14	
OFF ON			15	

Notes:  
 1 Negative legends not available on L, LD, LW, and N-Series.  
 2 Many symbols are SAE (J1362), ANSI and ISO approved symbols. Consult factory for custom symbols/icons.  
 3 Use "body" legend codes for laser etched image identification.

There are several catalogs available featuring complete details on all Carling Technologies products. Below is a list of useful information such as catalogs, brochures and videos. Please visit our website at [carlingtech.com](http://carlingtech.com) or scan the QR codes below for complete details.

[www.carlingtech.com](http://www.carlingtech.com)

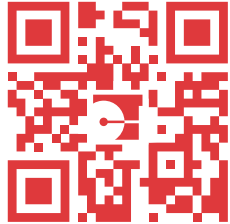
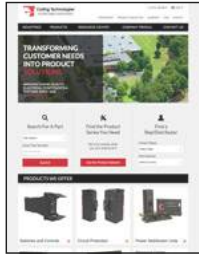

Watch Company Profile Video

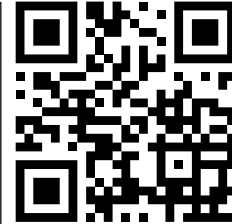

Switches & Controls

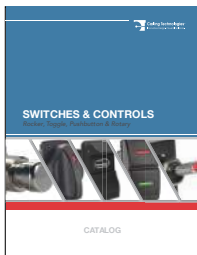

*catalog*

Complete line and ordering details for Switches & Control products including Rocker, Toggle, Pushbutton, and Rotary style switches.

Hydraulic-Magnetic

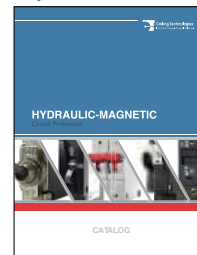

*catalog*

Complete line and ordering details for all hydraulic-magnetic circuit breakers.

Thermal



*catalog*

Complete line and ordering details for all thermal circuit breakers.

GFCI / ELCI

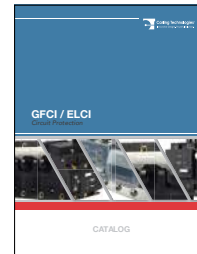

*catalog*

Complete line and ordering details for all GFCIs/ELCIs.

### Marine



catalog



brochure

Complete line of ELCIs, thermal and hydraulic-magnetic circuit breakers specific for marine applications.

### On-Off Highway



catalog



brochure

Complete line of switches, controls and custom solutions specific for on-off highway applications.

### Renewable Energy

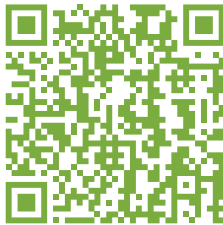
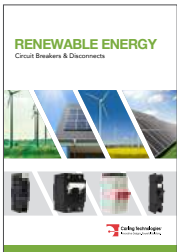

catalog



brochure

Complete line of circuit breakers and disconnect products specific for renewable energy applications.

### Military

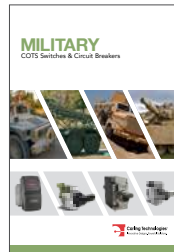

catalog



brochure

Complete line of CO<sub>T</sub>S (*Commercial-Off-The-Shelf*) switches and circuit breakers specific for military applications.

### Telecom/Datacom



catalog



brochure

Complete line of hydraulic-magnetic circuit breakers specific for telecom/datacom applications.

### Industrial Automation



brochure

Complete line of switches and circuit breakers specific for industrial automation & controls applications.

## Authorized Sales Representatives

Click on the group name on the map below to find your local representative or visit [www.carlingtech.com/findarep](http://www.carlingtech.com/findarep).

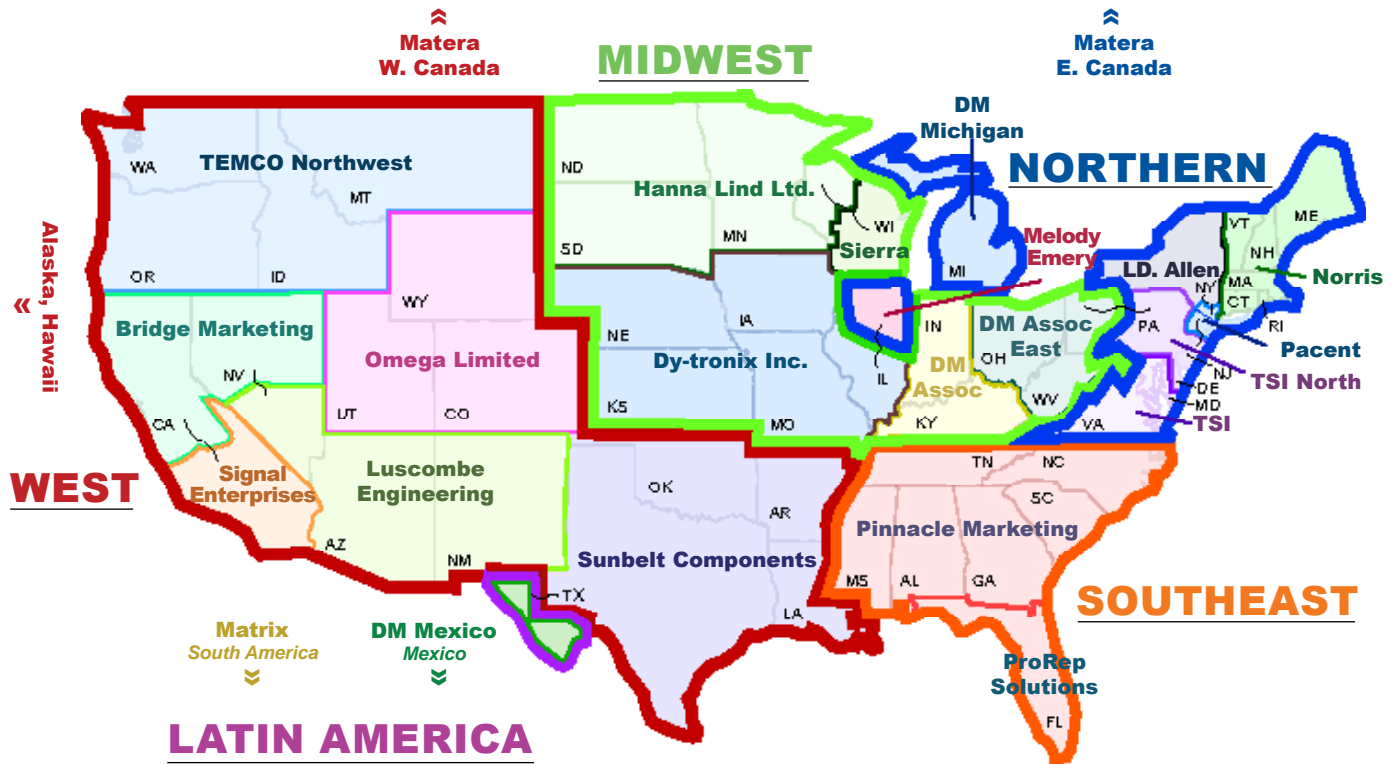

## About Carling

Founded in 1920, Carling Technologies is a leading manufacturer of electrical and electronic switches and assemblies, circuit breakers, electronic controls, power distribution units, and multiplexed power distribution systems. With four ISO registered manufacturing facilities and technical sales offices worldwide, Carling Technologies Sales, Service and Engineering teams do much more than manufacture electrical components, they engineer powerful solutions! To learn more about Carling please visit [www.carlingtech.com/company-profile](http://www.carlingtech.com/company-profile).

To view all of Carling’s environmental, quality, health & safety certifications please visit [www.carlingtech.com/environmental-certifications](http://www.carlingtech.com/environmental-certifications)

## Worldwide Headquarters

Carling Technologies, Inc.

60 Johnson Avenue, Plainville, CT 06062

Tel: (860) 793-9281

Fax: (860) 793-9231

Email: [sales@carlingtech.com](mailto:sales@carlingtech.com)

Web: [www.carlingtech.com](http://www.carlingtech.com)

### Northern Region Sales Office

[nrsm@carlingtech.com](mailto:nrsm@carlingtech.com)

### Southeast Region Sales Office

[sersm@carlingtech.com](mailto:sersm@carlingtech.com)

### Midwest Region Sales Office

[mrsms@carlingtech.com](mailto:mrsms@carlingtech.com)

### West Region Sales Office

[wrsms@carlingtech.com](mailto:wrsms@carlingtech.com)

### Latin America Sales Office

[larsms@carlingtech.com](mailto:larsms@carlingtech.com)

## Asia-Pacific Headquarters

Carling Technologies, Asia-Pacific Ltd.

Kowloon, Hong Kong

Tel: Int + 852-2737-2277

Fax: Int + 852-2736-9332

Email: [sales@carlingtech.com.hk](mailto:sales@carlingtech.com.hk)

### Shenzhen, China

[shenzhen@carlingtech.com](mailto:shenzhen@carlingtech.com)

### Shanghai, China

[shanghai@carlingtech.com](mailto:shanghai@carlingtech.com)

### Pune, India

[india@carlingtech.com](mailto:india@carlingtech.com)

### Kaohsiung, Taiwan

[taiwan@carlingtech.com](mailto:taiwan@carlingtech.com)

### Yokohama, Japan

[japan@carlingtech.com](mailto:japan@carlingtech.com)

## Europe/Middle East/ Africa Headquarters

Carling Technologies Ltd.

4 Airport Business Park, Exeter

Airport, Clyst Honiton, Exeter,

Devon, EX5 2UL, UK

Tel: Int + 44 1392-364422

Fax: Int + 44 1392-364477

Email: [ltd.sales@carlingtech.com](mailto:ltd.sales@carlingtech.com)

### Germany

[gmbh@carlingtech.com](mailto:gmbh@carlingtech.com)

### France

[sas@carlingtech.com](mailto:sas@carlingtech.com)

