

PC-Series

Ground Fault Circuit Protection





Overload, short circuit, & ground fault protection in a user friendly package!

The PC-Series, AC Residual Current Circuit Breaker with Overcurrent Protection (RCBO), combines the ground fault protection of a GFCI with the familiar overcurrent tripping characteristics of a normal circuit breaker.

The PC-series utilizes the hydraulic magnetic principle which provides precise operation and performance even when exposed to extremely hot and/or cold application environments.

Agency Certifications

UL Listed

UL Standard 489 Circuit Breakers, Molded Case, (Guide DIVQ, File E129899)



UL Standard 1077 Supplementary Protectors



UL Standard 943 Class A Ground Fault Circuit Interruptors



UL Standard 1053 Ground Fault Sensing and Relaying Equipment



UL Standard 1500 Ignition Protection (pending)

Product Bulletin #135 May 2010

For Additional Information:

Phone: (860) 793-9281
Fax: (860) 793-9231
email: sales@carlingtech.com
web: www.carlingtech.com
mail: Carling Technologies Inc.
60 Johnson Ave
Plainville, CT 06062

The PC-Series is suitable for:

- AC branch ground fault protection - a single circuit solution
- AC main ground fault protection for a boat's entire AC electrical system
- Portable generator ground fault protection

Key Benefits of the PC-Series:

- Increases safety around boats and marinas
- Protects against electrical shock hazards in areas near water
- Protects against defects in the wires & conductors
- Reduces fire and shock hazards from defects in permanently installed appliances such as water heaters, battery chargers, lighting fixtures, etc.
- Detects low level ground faults, which do not trip ordinary circuit breakers, that can lead to fires and shock hazards for boating occupants

Innovative Features:

These precision mechanisms are temperature stable and are not adversely affected by temperature changes in their operating environment. As such, derating considerations due to temperature variations are not normally required, and heat-induced nuisance tripping is avoided.

- Overload, short circuit and ground fault protection in a single package
- Handle style actuators and rocker style "acuguard"
- Wiping Contacts - Mechanical linkage with two-step actuation – cleans contacts, provides high, positive contact pressure & longer contact life
- A trip-free mechanism, a safety feature, makes it impossible to manually hold the contacts closed during overload or fault conditions.
- A common trip linkage between all poles, another safety feature, ensures that an overload in one pole will trip all adjacent poles.
- Front panel mounting
- Integral push-to-test button
- Two integrated LED indicators distinguish if a breaker is closed with Line Voltage present, or has opened due to leakage current, or has opened due to over current, or is closed with no Line Voltage present.
- Optional Hot/Neutral reversal detection and protection

Electrical

Current Rating	1 - 50 Amps maximum
Voltage Rating	120VAC, 120/240VAC
Leakage Current Trip Level	30mA & 6mA
Leakage Current Trip Time	For 30mA leakage trip: ≤ 22.2mA, shall not trip 30mA, shall trip within .10 seconds The above complies with UL-1053 & ABYC E11. For 6mA leakage trip: ≤25ms The above complies with UL-943.
Operating Frequency	50/60 Hz for 30mA leakage trip 60 Hz for 6mA leakage trip

Interrupt Capacity 5,000 Amps

Impedence

CURRENT (AMPS)	TOLERANCE (%)
0.10 - 5.0	15%
5.1 - 20.0	25%
20.1 - 50.0	35%

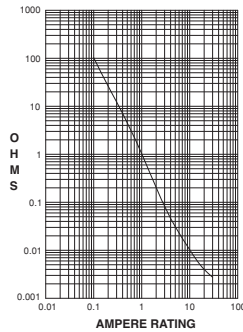

Innovative Features

Indicator	Two integrated LEDs, Red & Green <ul style="list-style-type: none"> •Green LED On, Red LED Off Line Voltage is present, the breaker is closed, and the device is protecting the circuits against over current and leakage current. •Green LED Off, Red LED On The device has detected leakage current and has opened the circuit breaker. •Green LED Flashing, Red LED Off The circuit breaker has opened due to over current or has been turned off manually •Green LED Off, Red LED Off Line Voltage is not present •Green LED Flashing, Red LED Off, Amber LED ON Indicates Hot & Neutral are reversed and the circuit breaker is open
Grounded Neutral Protection	When neutral is grounded on load side of circuit
Test Button	Located on Ground Fault Module

Physical

Number of Poles (Breakers only)	1-pole (1 Circuit Breaker + 1 GFCISensor Module), 120V 2-pole (2 Circuit Breakers + 1 GFCI Sensor Module), 120/240V or 120V with Neutral Break. 3-pole 120/240V with Neutral Break (Sensor module has 2 pole width)
Termination	Circuit Breaker Line Side: #10-32, threaded stud. GFCI Sensor Module Load Side: #10-32 threaded stud. Neutral pigtail.
Mounting	Front Panel, #6-32 and M3 threaded inserts.
Actuator	Handle, Flat Rocker, Curved Rocker (with or without rocker guard), Push-to-Reset Rocker.

Environmental

Designed and tested in accordance with requirements of specification MIL-PRF- 55629 and MIL-STD-202G as follows:

Shock	Withstands 100 G, 6ms, sawtooth at rated current per Method 213, Test Condition "I".
Vibration	Withstands 0.06" excursion from 10-55 Hz, and 10 G 55-500 Hz, at rated current per Method 204C, Test Condition A. Instantaneous and ultrashort curves tested at 90% of rated current.
Moisture Resistance/ Humidity	93% RH at 30°C for 168 Hours.
Corrosion	UL-943-6.21, 3 weeks Humidity: 30±2°C, 70±2% relative humidity Mixed Flowing Gases: 100 ppb H2S 20 ppb Cl2 200±50 ppb NO2
Operating Temperature	-35°C to +66°C
Mechanical	
Endurance	10,000 ON-OFF operations @ 6 per minute; with rated Current and Voltage.
Trip Free	Trips on short circuit, overload or leakage to ground, even when actuator is forcibly held in the "On" position

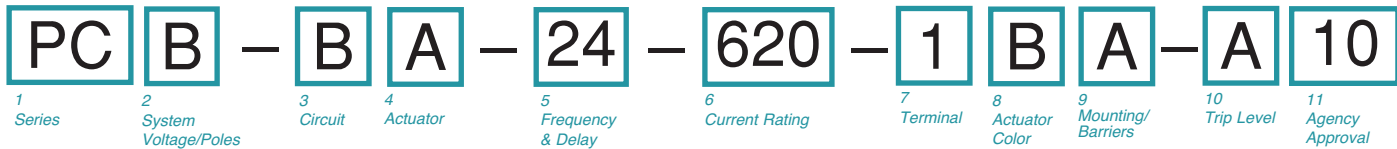

1 SERIES
PC

- 2 SYSTEM VOLTAGE / POLES**
- A 120 VAC single phase, one pole
 - B 120/240 VAC single phase, two pole
 - C 120/240 VAC single phase with switched neutral, three pole
 - D 120 VAC single phase with switched neutral, two pole
 - E 120 VAC single phase with reversed polarity indicator, two pole
 - F 120/240 VAC single phase with reversed polarity indicator, three pole

- 3 CIRCUIT**
- B Series Trip (Current)

- 4 ACTUATOR**
- Handle**
- A one per pole
 - B one per multipole unit
- Two Color Curved Visi-Rocker**
- C Indicate ON, vertical legend
 - D Indicate ON, horizontal legend
 - F Indicate OFF, vertical legend
 - G Indicate OFF, horizontal legend
- Single Color Curved Rocker**
- J Vertical legend
 - K Horizontal legend
- Two Color Curved Visi-Rocker Push-to-Reset**
- N Vertical legend
 - O Horizontal legend
- Single Color Curved Rocker Push-to-Reset**
- R Vertical legend
 - U Horizontal legend
- Two Color Flat Visi-Rocker**
- 1 Indicate OFF, vertical legend
 - 2 Indicate OFF, horizontal legend
- Single Color Flat Rocker**
- 3 Vertical legend
 - 4 Horizontal legend
- Two Color Flat Visi-Rocker Push-to-Reset**
- 5 Indicate OFF, vertical legend
 - 6 Indicate OFF, horizontal legend
- Single Color Flat Rocker Push-to-Reset**
- 7 Vertical legend
 - 8 Horizontal legend

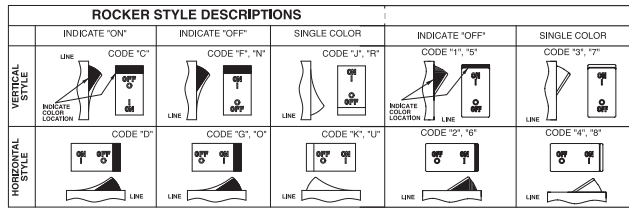

- 5 FREQUENCY & DELAY**
- 20 50/60Hz Instantaneous
 - 21 50/60Hz Ultra Short
 - 22 50/60Hz Short
 - 24 50/60Hz Medium
 - 26 50/60Hz Long

6 CURRENT RATING (AMPERES)

210	0.100	285	0.850	450	5.000	712	12.500
215	0.150	290	0.900	455	5.500	613	13.000
220	0.200	295	0.950	460	6.000	614	14.000
225	0.250	410	1.000	465	6.500	615	15.000
230	0.300	512	1.250	470	7.000	616	16.000
235	0.350	415	1.500	475	7.500	617	17.000
240	0.400	517	1.750	480	8.000	618	18.000
245	0.450	420	2.000	485	8.500	620	20.000
250	0.500	522	2.250	490	9.000	622	22.000
255	0.550	425	2.500	495	9.500	624	24.000
260	0.600	527	2.750	610	10.000	625	25.000
265	0.650	430	3.000	710	10.500	630	30.000
270	0.700	435	3.500	611	11.000	635	35.000
275	0.750	440	4.000	711	11.500	640	40.000
280	0.800	445	4.500	612	12.000	650	50.000

- 7 TERMINAL**
- 1 Stud, 10-32 threaded

8 ACTUATOR COLOR & LEGEND

I-O	ON-OFF	Dual	Legend Color
White	A	1	Black
Black	C	2	White
Red	F	3	White
Green	H	4	White
Blue	K	5	White
Yellow	M	6	Black
Gray	P	7	Black
Orange	R	8	Black

9 MOUNTING/BARRIERS

MOUNTING STYLE	BARRIERS
Handle or Standard Rocker Bezel Threaded Insert, 2 per pole	
A 6-32 X 0.195 inches	yes
B ISO M3 x 5mm	yes
Rockerguard Bezel Threaded Insert, 2 per pole	
C 6-32 X 0.195 inches	yes
D ISO M3 x 5mm	yes
Standard Bezel with Recessed Off-Side Flat Rocker Threaded Insert, 2 per pole	
E 6-32 X 0.195 inches	yes
F ISO M3 x 5mm	yes
Push-to-Reset Bezel Threaded Insert, 2 per pole	
G 6-32 X 0.195 inches	yes
H ISO M3 x 5mm	yes

- 10 LEAKAGE CURRENT TRIP LEVEL - MAX. TRIP CURRENT**
- A 6 mA (Class A GFCI)²
 - E 30 mA (ELCB)^{1,3}

- 11 AGENCY APPROVAL**
- AA W/O Approvals
 - 10 UL 943²
 - 11 UL 1053^{1,3}
 - 12 UL 1053 & UL 1500^{1,3,4}

Notes:
 1 This device meets the requirements of ABCY E11.
 2 6mA per UL943, available with agency approval code 10.
 3 30mA per UL1053, available with agency approval codes 11 & 12.
 4 AIC Rating at 120 VAC 3kA, at 120/240 VAC 5kA

INDICATE OFF / SINGLE COLOR
ROCKER ACTUATOR

HANDLE / INDICATE ON
ROCKER ACTUATOR

TERMINAL
LOCATIONS

PCA
120 VAC
VERSION

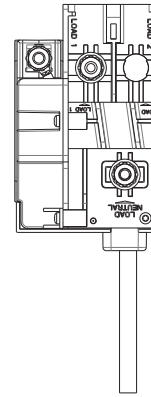
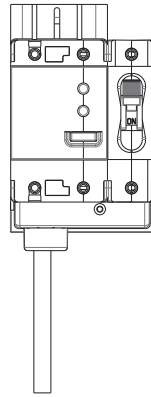
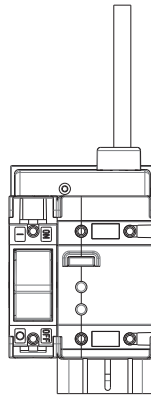

PCB
120/240 VAC
VERSION

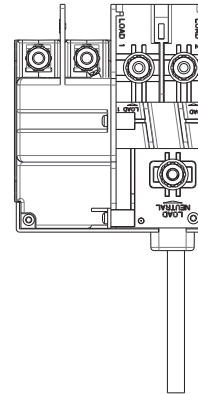
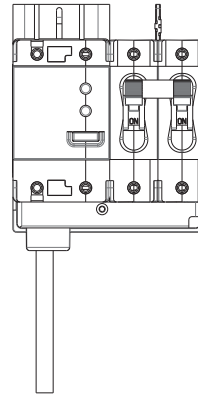
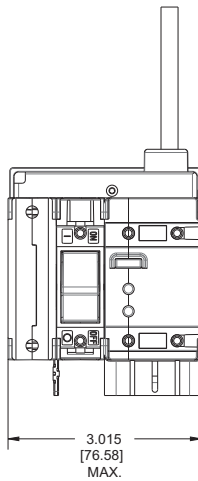

PCC
120/240 VAC
VERSION
W/ NEUTRAL BREAK

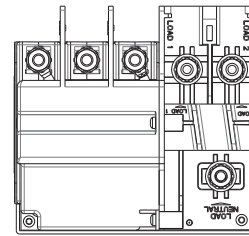
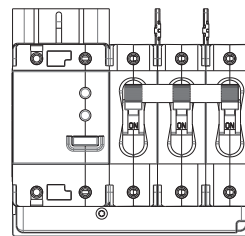
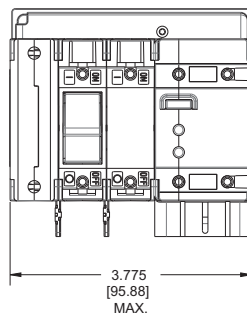

PCD
120 VAC
VERSION
W/NEUTRAL BREAK

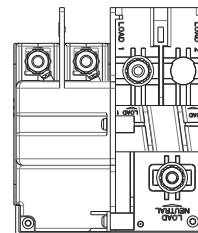
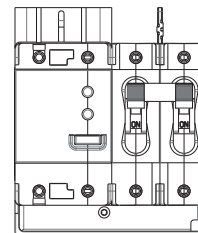
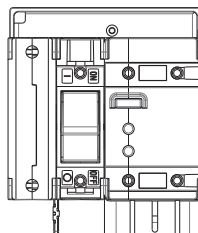

INDICATE OFF / SINGLE COLOR
ROCKER ACTUATOR

HANDLE / INDICATE ON
ROCKER ACTUATOR

TERMINAL
LOCATIONS

PCE
120 VAC VERSION
W/ REVERSE POLARITY
PROTECTION
& INDICATOR

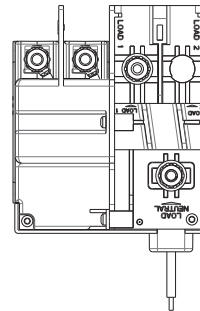
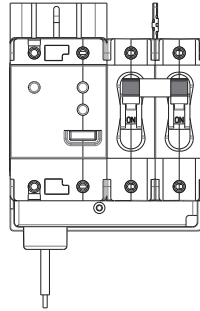
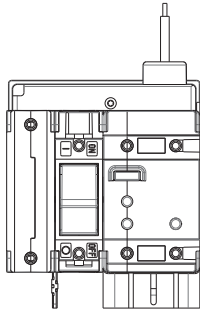

PCF
120/240 VAC VERSION
W/ REVERSE POLARITY
PROTECTION
& INDICATOR

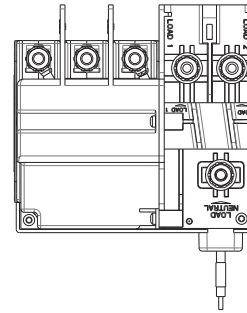
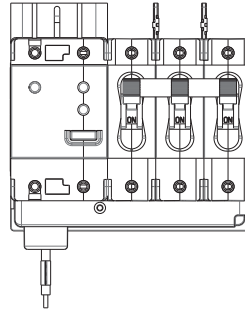
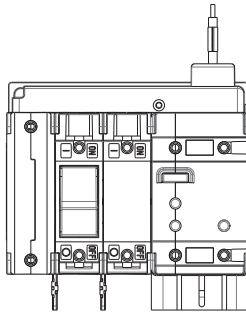

NOTE: NEUTRAL & GROUND PIGTAIL WIRES - SUPPLIED 12" LONG MIN. (CIRCUIT CODES A,B,E & F)

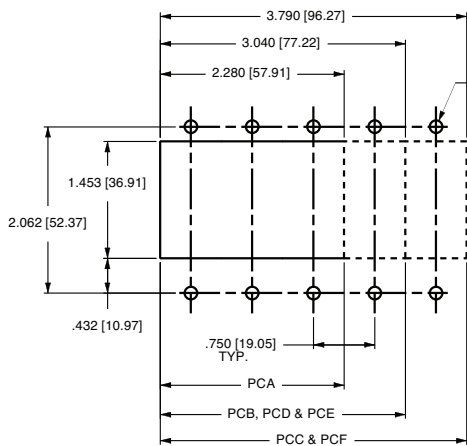

HANDLE ACTUATOR

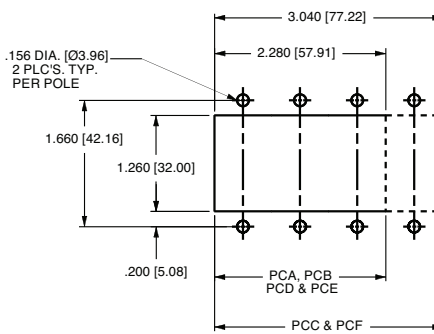

ROCKER ACTUATOR

PANEL CUTOUT DETAIL
TOLERANCES ±.005 [.12]

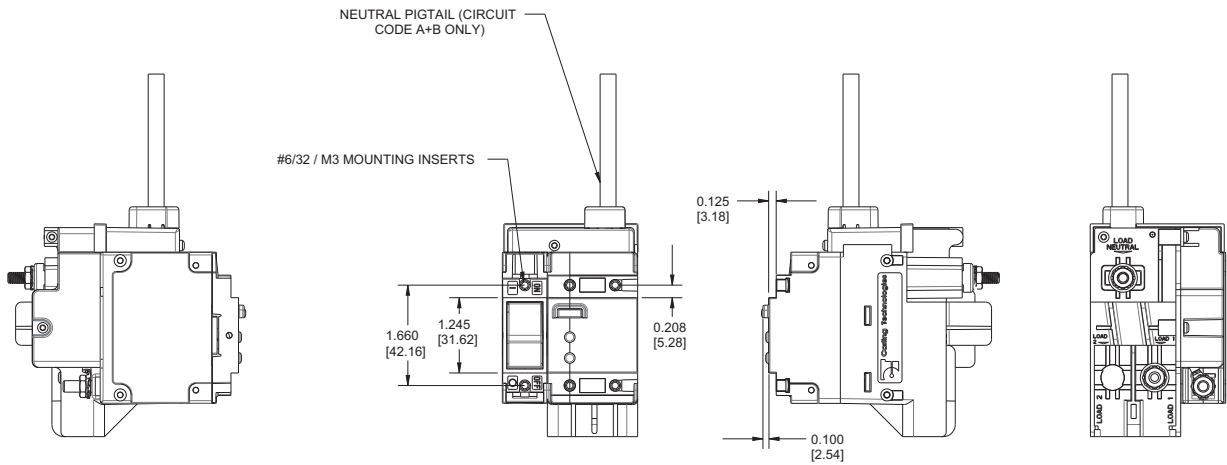
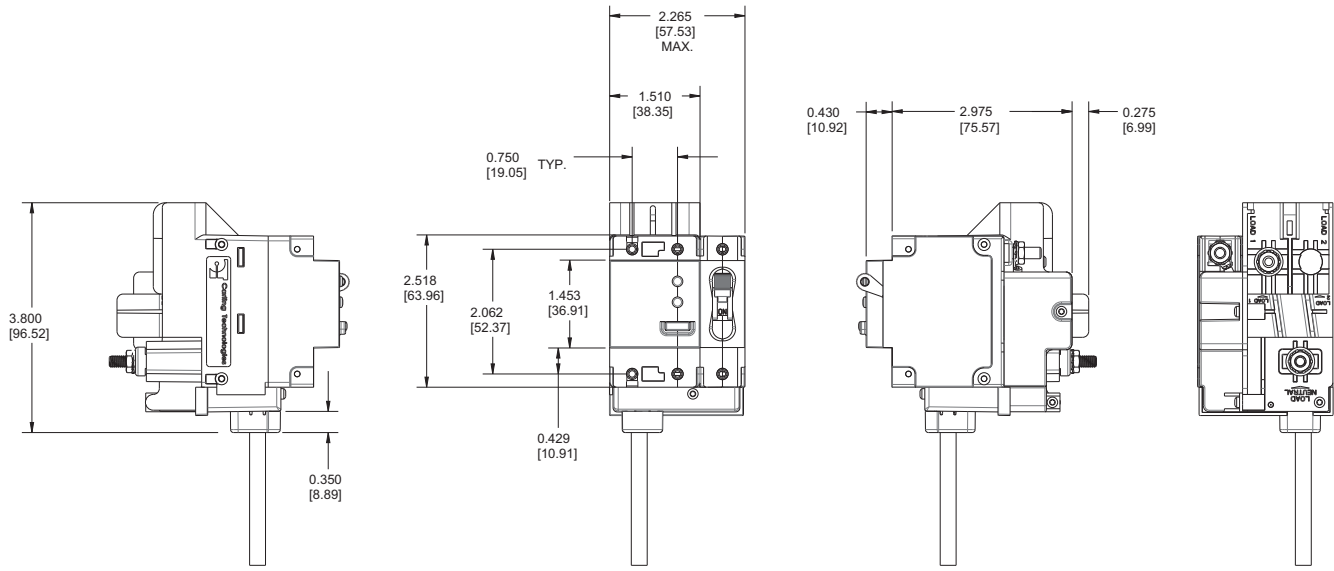

NOTE:
For additional circuit breaker dimensions, reference the C-Series Breakers in the Carling Circuit Protection catalog

Time Delay Curves

Instantaneous

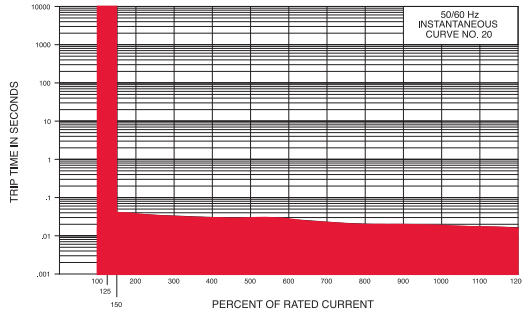

Medium

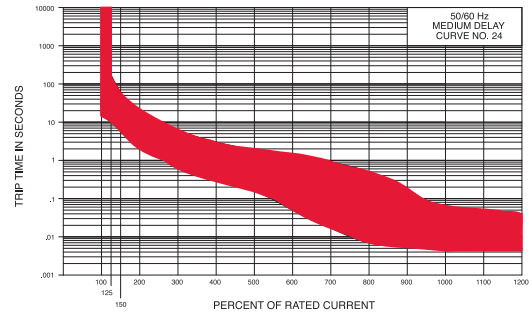

Ultra Short

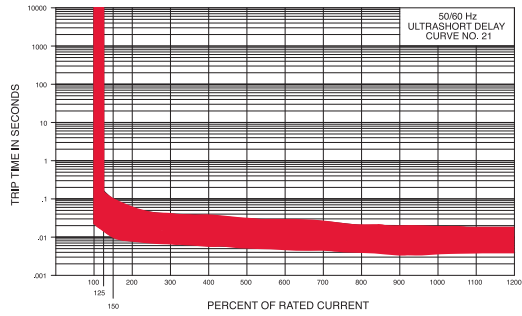

Long

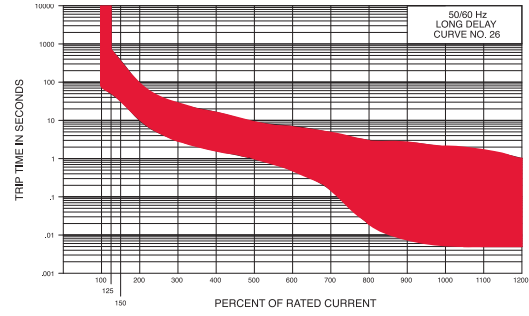

Short

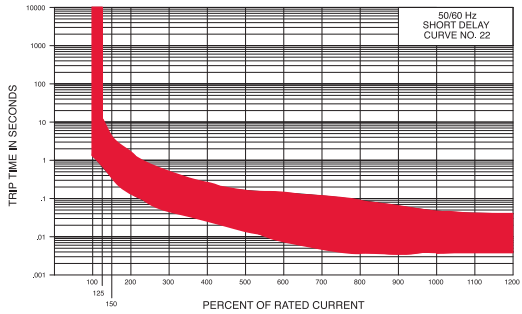

TIME DELAY VALUES									
PERCENT OF RATED CURRENT									
DELAY	100%	125%	150%	200%	400%	600%	800%	1000%	1200%
20	No Trip	May Trip	.040 MAX	.035 MAX	.030 MAX	.025 MAX	.020 MAX	.017 MAX	.015 MAX
21	No Trip	.014 - .150	.011 - .095	.008 - .055	.006 - .035	.005 - .027	.005 - .021	.004 - .018	.004 - .017
22	No Trip	.700 - 12.0	.350 - 4.00	.130 - 1.30	.027 - .220	.008 - .130	.004 - .090	.004 - .045	.004 - .040
24	No Trip	10.0 - 160	6.00 - 60.0	2.20 - 20.0	.300 - 3.00	.050 - 1.30	.007 - .500	.005 - .060	.005 - .040
26	No Trip	50.0 - 700	32.0 - 350	10.0 - 90.0	1.50 - 15.0	.500 - 7.00	.020 - 3.00	.006 - 2.00	.005 - 1.00

NOTES:
 Other time delay values available, consult factory.
 Delay Curves 21,22,24,26: Breakers to hold 100% and must trip at 125% of rated current and greater within the time limit shown in this curve.
 Delay Curve 20: Breakers to hold 100% and must trip at 150% of rated current and greater within the time limit shown in this curve.
 All Curves: Curve data shown represents breaker response at ambient temperature of 77°F (25°C) with no preloading. Breakers are mounted in standard wall-mount position.
 The minimum inrush pulse tolerance handling capability is 12 times the rated current. These values are based on a 60 Hz 1/2 cycle, 8.33 ms pulse.