

AC POWER DISTRIBUTION UNIT

A2000: 8 POSITION / 16 POSITION

The AC Power Distribution units provide the boat builder with up to 8 or 16 remotely controlled hydraulic-magnetic circuit breakers in one package that can be mounted virtually anywhere in the vessel. AC Circuit breakers are available from 1 to 100 amps and are remotely controlled via external solenoids. Each breaker can also be manually actuated. The AC units utilize a 16 bit microprocessor that controls the on/off function of each circuit breaker and provides interfacing to a dual CAN bus network. The AC unit enclosures are made from white, high strength, injection molded plastic that will provide years of protection in any environment.

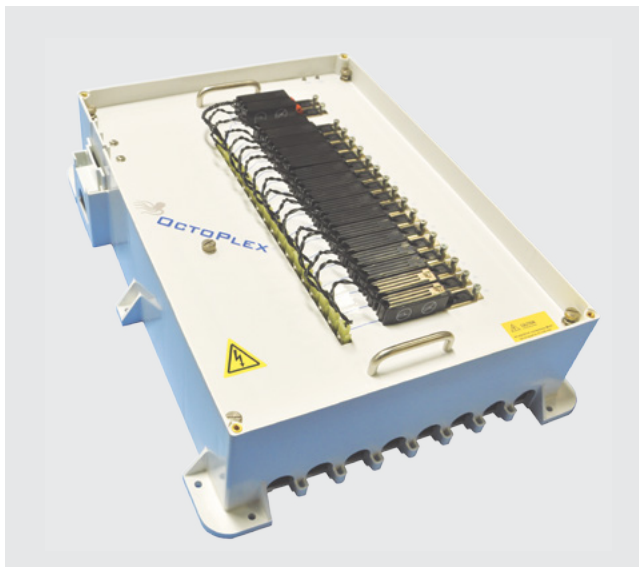

Product Highlights (8 & 16 Position Unit):

- ◆ 100 Amps Maximum Capacity
- ◆ Remote Actuation of Breakers
- ◆ Dual CAN BUS Communication
- ◆ Three Phase Power Capability



Configuration

Configuration of an OctoPlex® AC Unit and its associated functions can be performed running ONC on a computer with a CAN interface or a capably configure MFD. Configuration from within ONC provides access to all configurable aspects of an AC Box. Consult the ONC User's Guide for complete details on adjusting configurable parameters. The Flat Panel's interface to AC Box configuration is a limited subset of parameters to provide on-the-fly adjustments. AC box configuration settings are initially loaded and controlled with the ONC utility and contained in Box Configuration Files (BCF). The following parameters may be modified directly from the MFD:

ONC Analyzer Configuration Parameters

Parameter	Setting	Description
Default State	ON, OFF, Last State	Circuit breaker state on network power up
Default Lock State	ON or OFF	Lock state on network power up
Default to Last State	ON or OFF	Last known state on network power up
Configuration Allowed	YES or NO	Allow user to modify Circuit Breaker via Multi-Function Display
Alarm on Trip	YES or NO	Audible alarm when breaker trips



CAUTION!

When "Default to Last State" is set to "ON" it overrides the "Default State" setting.

*Manufacturer reserves the right to change product specification without prior notice. Please refer to our website for the latest details.

Part Numbers

Part Number ¹	Description	Number of Positions	
		8	16
A2000-X-1-CE	AC Power Distribution Unit - 120V (1 Buss Bar)	X	X
A2000-X-2-CE	AC Power Distribution Unit - 120/240V (2 Buss Bars)	X	X
A2000-X-3-CE	AC Power Distribution Unit - 120/208V (3 Buss Bars)	X	X
A2000-X-4-CE	AC Power Distribution Unit - 240V Single Pole	X	X
A2000-X-5-CE	AC Power Distribution Unit - 240V Double Pole	X	X

Notes:

1. "X" designates the number of breaker positions available for that voltage configuration; see Number of Positions Column

Breaker Slot / Offset Load Circuit Relationship

The number of available circuit breakers in an AC Distribution Unit for loads will vary depending on the AC input power type 120V or 230V (Euro Single Phase), 240V or three Phase.

Single Pole breakers: 120V and 230V Euro loads require a single breaker slot.

Double Pole breakers: 240V loads requires two physical breaker slots.

Three Pole breakers: 120/208V requires three physical breaker slots.

The AC Distribution Unit may contain different combinations of breaker; therefore, the total number of supported load circuits in a given unit will vary depending on the load type mix;

AC Unit Type	120V / 230V Single Pole	240 Double Pole	3-Phase Three Pole ¹
8 Position	8	4	2
16 Position	16	8	5

Notes:

1. Three (3) Phase breakers start with position 5, allowing for a total of 15 physical slots

The Panel Breaker numbers, as identified on the panel cover, start with one at the top. The main breaker (when used) will occupy slots one through three depending on the main breaker configuration, single, double or triple pole.

AC Breaker Type	Main Breaker Slots Used	Load Breaker Slots
Single Pole	1	Begins with Slot 4
Double Pole	2	Begins with Slot 4
Three Pole	3	Begins with Slot 5



NOTE

The highest AC Breaker Rating (amps) should be installed in lowest breaker position (i.e. Position 1, 2, etc.) to ensure proper load distribution. For example: Breaker Positions 1-2 has 100A breaker installed; breaker position 4 has 70A breaker installed; etc.

Breaker Control by Discrete I/O Function

Analog input signals to the System Interface Unit Monitor (SIU) can trigger a Discrete I/O function in the AC processor, which can be used to control the behavior of a Circuit Breaker. Sixteen Discrete I/O's per AC Unit can be programmed. One Discrete I/O can control multiple breakers up to the unit limit. Discrete I/O functions are configured using ONC.

Discrete I/O	Description
Turn On	Turn AC Breaker ON
Turn Off	Turn AC Breaker OFF
Off & Lock	Turn AC Breaker OFF and Lock in OFF position

AC Breaker Assignment Considerations

Installations that include remote control of breakers via N2kView must be aware of the relationship and offsets between the N2kView Configuration and the OctoPlex AC breaker position.

Panel Breaker #	N2kView Switch	ONC 1ØBox	ONC 3ØBox	Line 1ØBox	Line 3ØBox	Comments
1				A	A	Main 3Ø - 1 Ø or Double Pole
2				B	B	Main 3Ø - 1 Ø if Double Pole
3				NU	V	Main 3Ø - NU-1Ø SP and DP
4	1	1	NU	B	NU	Load 1 -1Ø
5	2	2	2	A	A	Load 2 -1Ø Load 1-3Ø
6	3	3	3	B	B	Load 3 -1Ø Load 2-3Ø
7	4	4	4	A	C	Load 4 -1Ø Load 3-3Ø
8	5	5	5	B	A	Load 5 -1Ø Load 4-3Ø
9	6	6	6	A	B	Load 6 -1Ø Load 5-3Ø
10	7	7	7	B	C	Load 7 -1Ø Load 6-3Ø
11	8	8	8	A	A	Load 8 -1Ø Load 7-3Ø
12	9	9	9	B	B	Load 9 -1Ø Load 8-3Ø
13	10	10	10	A	C	Load 10 -1Ø Load 9-3Ø
14	11	11	11	B	A	Load 11 -1Ø Load 10-3Ø
15	12	12	12	A	B	Load 12 -1Ø Load 11-3Ø
16	13	13	13	B	C	Load 13 -1Ø Load 12-3Ø
17	14	14	14	A	A	Load 14 -1Ø Load 13-3Ø
18	15	15	15	B	B	Load 15 -1Ø Load 14-3Ø
19	16	16	16	A	C	Load 16 -1Ø Load 15-3Ø
Main	17	17	17			Main Breaker

AC Main Circuit Breaker Installed - Unit Configurations

There are three distinct AC Distribution Box configurations depending on the type of line input; each requires different hardware options depending on the input line configuration. This configuration must be determined prior to ordering the AC Boxes.

1. Single Phase (1Ø) 120 or Euro 230 VAC
2. Single/Split Phase (1Ø) 120/240 VAC
3. Three Phase (3Ø) 120/208 VAC

For 120 and Euro 230 VAC single phase configurations the Line Bus Bars (A & B) are jumpered together at the factory using a bus bar jumper.

For 120/240 VAC split phase the Line Bus Bars are not tied together at the factory, allowing two legs of 120 VAC to be brought into the box for single or double pole circuit breaker installation.

AC No Main Circuit Breaker Installed - Unit Configurations

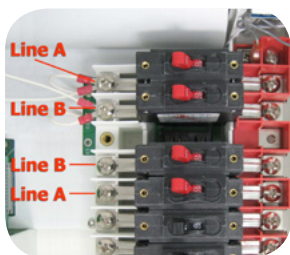

Single Phase Dual Line 120/240VAC: Line Bus Bars 1 and 2 are not tied together at the factory, allowing two legs of 120/240VAC to be brought into the unit for single or double pole circuit breaker installation. Breaker position 1 is line 1, breaker position 2 is line 2, and then they alternate. For 120/208 VAC three phase a third Line Bus Bar (C) is added and up to 15 single pole breaker positions are available for loads.

Installation

The AC Power Distribution Unit is designed to be installed in an environmentally protected, non-explosive area of the vessel. Take precautions to mount the unit in an area that will be away from direct exposure to water, weather and combustible fumes.

Mounting

These units should be mounted in a location that is accessible for manual/override control and serviceability. These units must be mounted in vertical position only. Installations in horizontal position (flat) with breakers facing up or down can compromise the accuracy of the AC circuit breaker function.

AC Main Connections

Depending on configuration, connection points are provided for single 120VAC, Single 240VAC (Euro), dual 120/240VAC or three phase (120/208VAC) AC line inputs. Bus bars are provided for AC neutral (White or Blue) and grounding (Green or Green-Yellow) conductors. Main feed wires entering the panel are secured to prevent strain using a screw down “clamp” provided at the opening on the outside of the panel.



HIGH VOLTAGE!



WARNING!

Lethal voltages are present inside the AC unit. Verify that all AC power is shut off or disconnected before working inside the unit. **Required Torque** for each AC breaker terminal screw is 35 inch-lbs. This torque requirement must be applied to all circuit breaker terminal screws, no exceptions. Failure to properly torque each connection may result in damage to the AC Unit or vessel.



CAUTION!

The installer is responsible for verifying that the wire gauge used for the main power feed is appropriately sized for the loads being fed from the AC unit. The unit is designed to accept up to #1 gauge wire for the main power feed. All personnel performing installation or maintenance work on the AC Unit will need to have a calibrated torque screwdriver in order to verify proper installation of the circuit breakers and associated connections.

AC Branch Circuit Connections

Branch circuit wires enter the AC Power Distribution Unit through the openings at the bottom of the panel. Line conductors are connected to their respective circuit breaker. Neutral and grounding conductors are connected to bus bars provided. Branch wires entering the panel are secured to prevent strain using a screw down “clamp” provided inside of the panel. Circuit breakers are in sequential order from top to bottom. “Tie bars” connecting circuit breaker handles for double and triple pole breakers must be used.

CAN Connections

Two male Micro-C connectors are provided at the bottom left side of the 8 Position or at the top left side of the 13/19 Position unit for connection to the primary and secondary CAN bus via drop cables.



NOTE

Use the shortest drop length possible when connecting the AC Unit to the CAN backbone. NMEA 2000 spec is maximum 6 meters for drop cables.

Operation

Depending on the AC Unit power configuration, 120VAC, Single 240VAC (Euro), dual 120/240VAC or three phase (120/208VAC), there up to three LED's visible through the cover of the AC Power Distribution Unit. This power indication is derived from the Line input and does NOT reflect the state of the main breaker, if so equipped. As long as AC power is present, the AC Unit will be recognized by the Multi- Function Display (MFD). When AC power is not present, you will not be able to control the AC circuit breakers.

Manual Operation

All AC Circuit Breakers can be controlled directly from the AC Power Distribution Unit (bypassing control from the Multi-Function Display(s)). Follow the instructions below to manually control an AC Circuit Breaker:

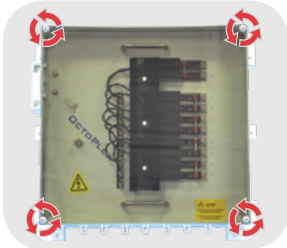

Step #1:

Remove the cover to the AC Power Distribution Unit by unscrewing the four screws located at each corner of the unit.



Step #2:

Operate the toggle lever for the desired circuit breaker.
Replace the cover when done.



CAUTION!

When manually controlling AC circuit breakers, any time you turn one to the "OFF" position, the system will consider this a tripped breaker and activate the audible alarm if configured to do so. The system sees this as a trip because the system did not command the breaker "OFF".



WARNING!

Lethal voltages are present inside the AC Unit. Verify that all AC power is shut off or disconnected before working inside the unit.
When a circuit breaker is turned off manually, it can still be controlled via the Multi-Function Display (MFD). This could present a hazard when performing maintenance on a circuit. It is good practice to "lock" a breaker in the "OFF" position from the Multi-Function Display (MFD) when performing any required maintenance on a circuit. Refer to page 11 for Locking Function.

Maintenance

The AC Unit was designed to require minimal, if any, maintenance. The only field serviceable parts in the AC Unit are the Circuit Breakers and Solenoids.

Breaker Replacement

The AC circuit breakers are not interchangeable like the breakers in the DC Units. If an AC breaker value/rating needs to be changed, the AC Power Distribution Unit will need to be disassembled. Below are the steps required for replacing an AC breaker:



WARNING!

Lethal voltages are present inside the AC Unit. Verify that all AC power is shut off or disconnected before working inside the unit.



Step #1:

Turn off the main power feeding the AC Power Distribution Unit at the source. Turn all breakers to OFF position. Do not remove the front panel if the LED's are lit (indicating that AC power is being provided to the panel).

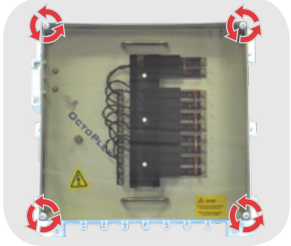

Step #2:

All Remote Actuators (solenoids) need to be disconnected and removed by loosening the screws to the right of the circuit breaker handle, and disconnecting the wires to the left.

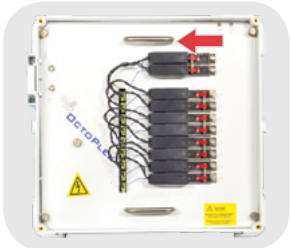

Step #3:

Turn the main AC breaker to the OFF position, if configured.

With all Remote Actuators removed, the five large thumb screws can be loosened and four small Phillips head screws removed allowing the cover to be opened.



Step #4:

Remove each solenoid by turning the screw counter-clockwise and disconnecting the plastic connector at the end of the wire lead. Once each screw is loosened, lift the solenoid in the upright position from the screw side and pull from the box. Be careful when pulling the solenoid away as there are tabs at the back end of each, which hold it in place within the sub-panel cover.

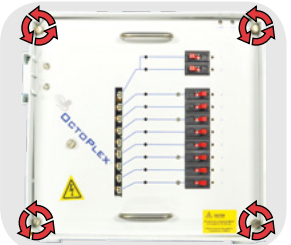

Step #5:

Once the cover is removed, buses for the ground, neutral, and lines, as well as all AC breakers can be accessed.

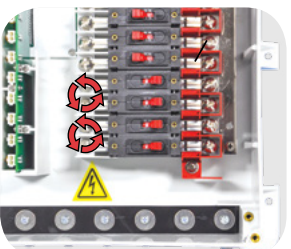

Step #6:

Once any required changes are made, the AC Power Distribution Box can be reassembled by reconnecting the ground wire to the cover, replacing and securing the cover with the four screws, and re-installing all Remote Actuators (making sure that connectors line up properly with their corresponding circuit breaker) and tie bars as required



Required Torque for each AC breaker terminal screw is 35 inch-lbs. This torque requirement must be applied to all circuit breaker terminal screws, no exceptions. Failure to properly torque each connection may result in damage to the AC Unit or vessel.



All personnel performing installation or maintenance work on the AC Unit will need to have a calibrated torque screwdriver in order to verify proper installation of the circuit breakers and associated connections.

General Specifications

Electrical

Operating Voltage, Power Input (Single Phase)	120VAC; Euro 230VAC
(Double Phase)	120/240VAC
(Three Phase)	120/208VAC
Max Current, Power Input	100 Amps
CAN Bus Operating Voltage	9 VDC – 16 VDC, 15 VDC Nominal
Load Equivalence Number (LEN)	2

Mechanical

8 Position Dimensions	14.46" X 15.76" X 5.04"
16 Position Dimensions	20.50" X 15.76" X 5.04"
CAN Bus Connectors	Two (2) Micro-C Male
8 Position Mounting	8 each
19 Position Mounting	10 each
Orientation	Vertical Position (not flat)

Certifications

NMEA 2000	Category B
Lloyd's Register	Lloyd's Type Approved, Test Specification #1, Env 2
CE	IEC 60533 Electrical and Electronic Installations in Ships IEC 60945 Maritime Navigation and Radio Communication Equipment and Systems

Environmental

Radiated, RF Field Immunity	IEC-61000-4-3
Electrical Fast Transient/Burst Immunity	IEC 61000-4-4
Voltage Surge Immunity	IEC 61000-4-5
Conducted, Immunity	IEC 61000-4-6
Conducted Emissions	IEC 60945
Voltage Variation Immunity	IEC 61000-4-11
Conducted LF Immunity	IEC 61000-4-16
ESD Immunity	IEC-61000-4-2
Insulation Resistance	IEC-60092-504
Operating Temperature	-20°C to +55°C
Storage Temperature	-20°C to +55°C
Vibration	IEC-60068-2-6 Test Fc
Temperature Cycle	IEC 60945
Humidity	IEC-60068-2-30 Test Db
Corrosion	IEC 60945
Weight <i>with breakers</i>	A2000-08-[]-CE: 16.5 lbs. (7.5 kg) A2000-16-[]-CE: 20 lbs. (9.1 kg)

Dimensional Specifications: in. [mm]

8 Circuit DC Power Distribution Unit A2000-08-[]-CE

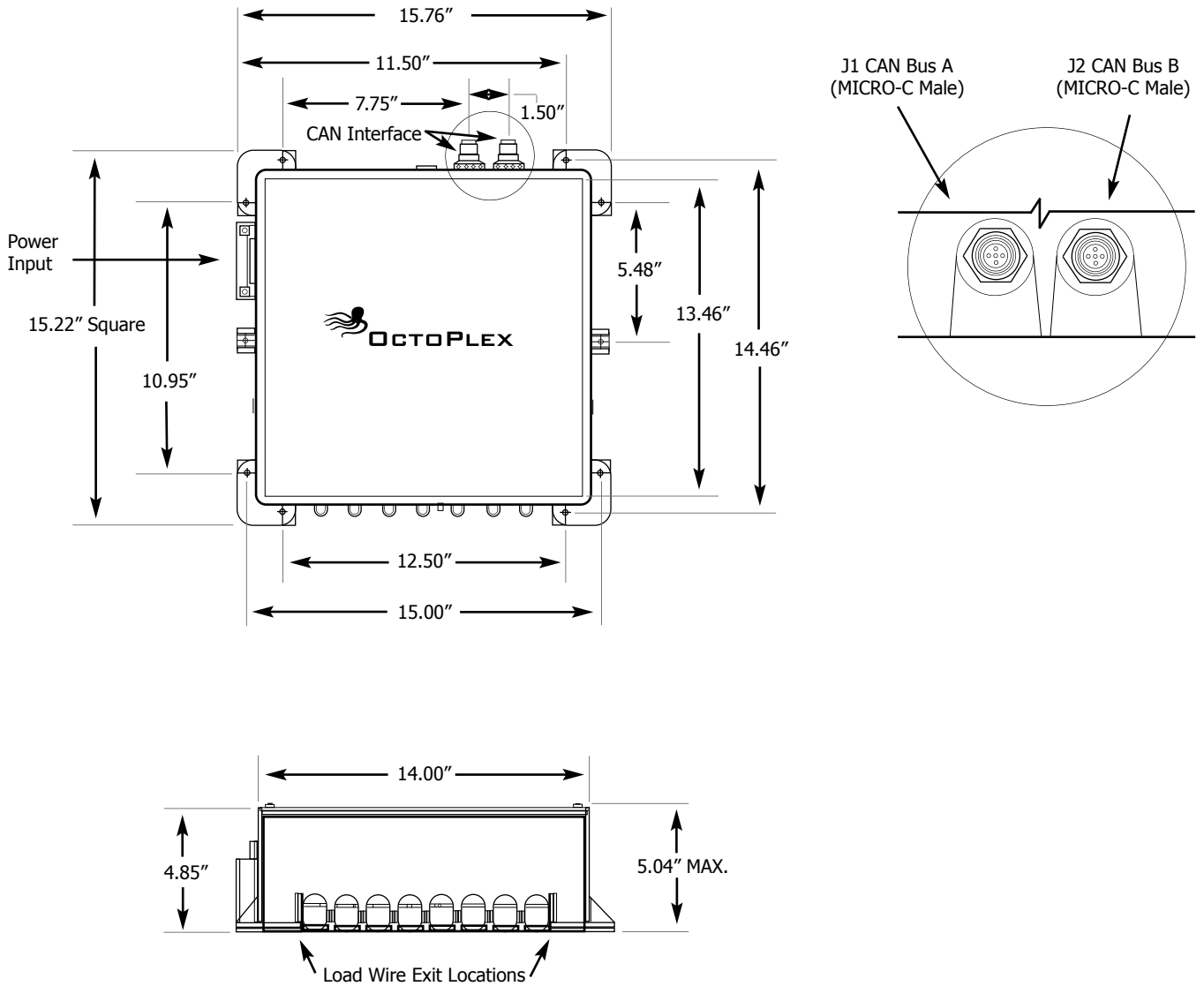

Dimensional Specifications: in. [mm]

13 Circuit DC Power Distribution Unit A2000-16-[]-CE

