

VMM-SERIES

MULTIPLEXED SWITCH MODULE

The VMM-Series is a sealed, multiplexed switch module featuring the Carling V-Series Contura® rocker switch styles. The VMM-Series reduces the complexity and cost of traditional wiring harnesses, increases product life and reliability, and reduces installation time.



Product Highlights:

- NMEA2000® CAN Protocol
- IP68 Sealing Protection with Connector
- Configurable
- Horizontal or Vertical Mounting Options

Model Number:

- VMM6



VMM-Series

DESIGN FEATURES

SEALING PROTECTION

Fully sealed IP68 front panel and back panel (when connected)



CUSTOMIZABLE ICONS

Choose from our extensive library of legends, or customize your own.

ROCKERS

Variety of V-Series Contura® actuator styles

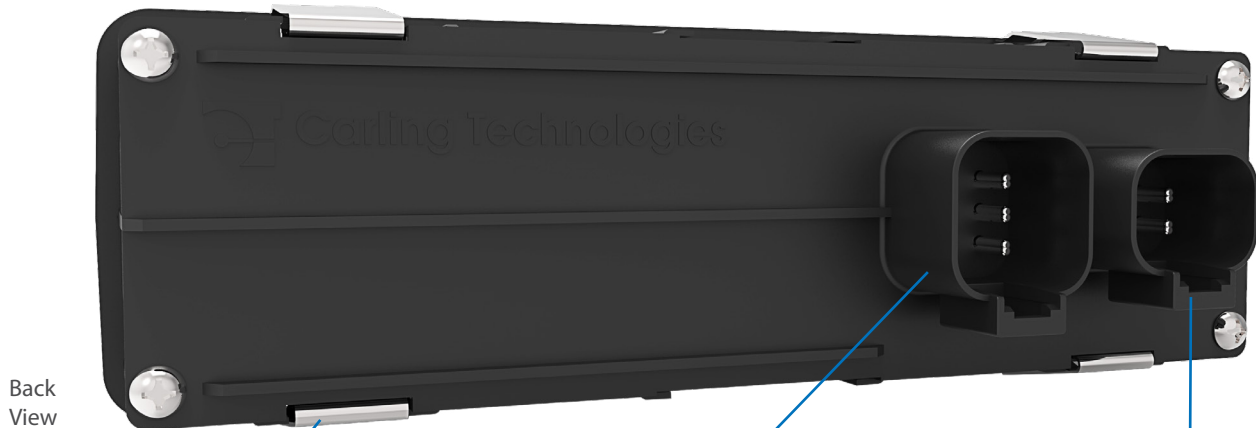

SNAP-IN MOUNTING

For fast, easy assembly.

6 PIN CONNECTOR

Mates to the Deutsch DT-Series Connector.

4 PIN CONNECTOR

Reserved for future use.

INTERFACE ADAPTER CABLE

Deutsch to CAN
(Part Number A3702 & A3702-1)

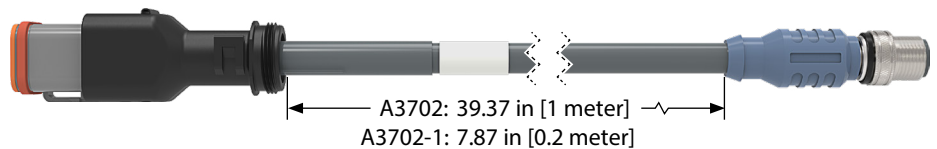

Electrical

Operating Voltage	12VDC or 24VDC systems Min: 9VDC Max: 32VDC
Max Current	Operation: 300mA
Communication Programming	Master: CAN 2.0b (NMEA2000®) At factory or via CAN by special tool
Reverse Polarity	12V systems: -24V for 5 minutes 24V systems: -36V for 5 minutes
Withstand Voltage	ISO 16750-2 500Vrms (50Hz to 60 Hz) with a duration of 60s
Insulation Resistance	ISO 16750-2 500VDC with a duration of 60s
Superimposed Alt. Voltage	ISO 16750-2 severity 2, Upp of 4V for Un=12V and Un=24V
Overtoltage	ISO 16750-2 Apply voltage DC 36V for 60min at 65 °C
Supply Voltage	<u>Slow Decrease/Increase</u> : Test according to ISO16750-2- 4.5 <u>Momentary Drop</u> : Apply the test pulse according to ISO 16750-2 (Figure 4 for 12V system, Figure 5 for 24V system)
Electrical Endurance	Minimum 250,000 Operations (50k cycles at Tmin, 150k cycles at Tnom, 50k cycles at Tmax)

Physical

Number of Switches	6 per module
Actuator Type	Rockers – all Contura styles (No locking feature available)
Materials	Housing - Acetal, UV stabilized Back Cover - Acetal, UV stabilized Rocker – Polycarbonate / Nylon Mounting Clips – Stainless steel
Weight	≈0.5 lbs
Functions	Each of the 6 switches can be one of the following mechanical types: 2-position maintained, 2-position momentary top, 2-position momentary bottom, 3-position maintained, 3-position momentary top and bottom, 3-position momentary top, or 3-position momentary bottom. See next page for more details.
Illumination	Single-color LED Red, Green, Amber, Blue, White See next page for more details.
Dimming	Backlight and function indicator brightness can be set independently.
Connection	Deutsch DT-Series 4 and 6 pin connectors
Mounting	Front panel, removable from a-side
Panel Opening	See dimensional specifications
Depth Behind Panel	≈ 1.6in (41mm) to bottom of header

Environmental

Operating Temperature	-40 °C to +85°C
Thermal, Hot Soak	EN 60068-2-2 Test Bb, 85°C for 96 hours
Thermal, Cold Soak	EN 60068-2-1 Test Ad, -40°C for 96 hours
Thermal, Shock	EN 60068-2-14 Test Na, -40°C to 85°C, 10 cycles for 10 hours
Humidity, Soak	EN 60068-2-78 Test Cab, 30°C at 93% RH for 10 days
Humidity, Cyclic	EN 60068-2-30 Test Db Method 1, 55°C to 25°C at >90% RH, 6 cycles of 24 hours each
Thermal, Cycling	EN 60068-2-14 Test Nb, -40°C to 85°C, 2 cycles of 8 hours each
Solar Radiation	EN 60068-2-5 Procedure B, 40°C for 10 days
Ingress Protection	IEC 60529, IP68, 1.2m deep water for 60+/-2 min
Shock	EN 60068-2-27, 3 shocks in each direction of the 3 axes (18 total shocks) at 500 m/s2 for 11 ms
Bump	EN 60068-2-27, 100 shocks in each direction of the 3 axes (600 total shocks) at 400 m/s2 for 6 ms
Drop	EN 60068-2-31 Test Ec Free Fall – Procedure 1, drop in each direction of the 3 axes (6 total drops) from 500mm
Vibration, General	EN 60068-2-6, swept sine wave from 5-500 Hz, +/-15 mm amplitude, 5g, 20 cycles in each plane
Vibration, Random	EN 60068-2-64 Test Fh Method 1, random excitation at 10, 150, 220, and 350 Hz breakpoint frequencies, 5 hours in each axis
Vibration, Resonance	EN 60068-2-6, sinusoidal from 10-2000 Hz, 5 minutes at resonant points
Chemical Resistance	ISO 16750-5 Method II for Engine oil, hydraulic oil, diesel fuel, Grease and Urea at Tmax.
Salt Spray	EN 60068-2-52 Test Kb, severity level 4

Electromagnetic Compatibility (EMC)

	Reference limits from ISO 13766 (Earth Moving Machinery) and EN 13309 (Construction Machinery)
Absorbed-Lined Chamber	ISO 11452-2, 100V/m, 20MHz to 2GHz
Bulk Current Injection	ISO 11452-4, 100mA, 20MHz to 400MHz
Transient Emission	ISO 13766 Annex D and E, 30MHz-1GHz
Conducted Transients	All test pulses according to ISO 7637-2:2004, Annex Table A2 for 24V systems Level 3 minimum
ESD	ISO 10605, ±15kV air discharges, ±8kV contact discharges

*Manufacturer reserves the right to change product specification without prior notice.
GPS-0013 Rev: A

Functions

The mechanical type for each switch must be programmed into the module via CAN message(s).

Switch position will be reported via NMEA2000® Standard “Binary Switch Bank Status” CAN message. To allow each switch to report up to three discrete positions, the top and bottom switch positions will be considered separate binary (on or off) switches and will be numbered as follows:



Illumination

There will be a total of twelve single-color LEDs, and each will be configurable via CAN message to act as a backlight or a function indicator. The LEDs will be located under the top and bottom of each rocker, and will be one of the following colors: Red, Green, Amber, Blue, or White. All LEDs set as backlights will share the same brightness and on/off values.

LEDs set as function indicators can be tied to a channel of any device on the CAN network that reports the NMEA2000® standard “Binary Switch Bank Status” message. When the associated channel reports it is in the “on” state, the LED will be turned on and set to the function indicator brightness level. When the associated channel reports it is in the “off” state, the LED state will depend on if it is also set as a backlight. If it is, it will be on at the backlight brightness level. If it is not, it will be off.

Table A: Illumination Table (for each switch position)

Location	Type	Color	Option
Top LED	Backlight	Red, Green, Amber, Blue or White	Continuous or Flashing
	Function	Red, Green, Amber, Blue or White	ON with Switch, ON with Device
Bottom LED	Backlight	Red, Green, Amber, Blue or White	Continuous or Flashing
	Function	Red, Green, Amber, Blue or White	ON with Switch, ON with Device

Connector Pin Layout:

Connector 1 (mating connector: Deutsch DT-Series 4 pins)

Pin	1	2	3	4
Signal	Reserved for future use			

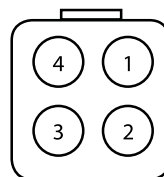

Connector 2 (mating connector: Deutsch DT-Series 6 pins)

Pin	1	2	3	4	5	6
Signal	CAN_L	CAN_H	NC	NC	GND	VCC

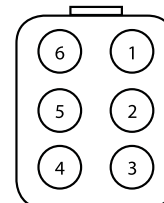

Further details regarding software can be found in the Software Interface Integration Specification document.

Ordering Scheme: Part 1 (Module and Rocker Style)

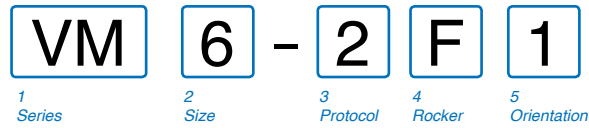

1 SERIES
VM V-Series Module System

2 SIZE
6 6 Positions

3 COMMUNICATION PROTOCOL
2 NMEA2000®

4 ROCKER STYLE

A Contura II	B Contura III
C Contura IV	D Contura IV - Laser Etched
E Contura V	F Contura V - Laser Etched
G Contura VI	H Contura VII
J Contura X	K Contura XI
L Contura XII	M Contura XIV
N Contura XIV - Laser Etched	
Z No Rockers	

5 ORIENTATION

1 Landscape	2 Portrait
3 Reverse Portrait	4 Reverse Landscape

Ordering Scheme: Part 2 (Module Circuit and Lamps)

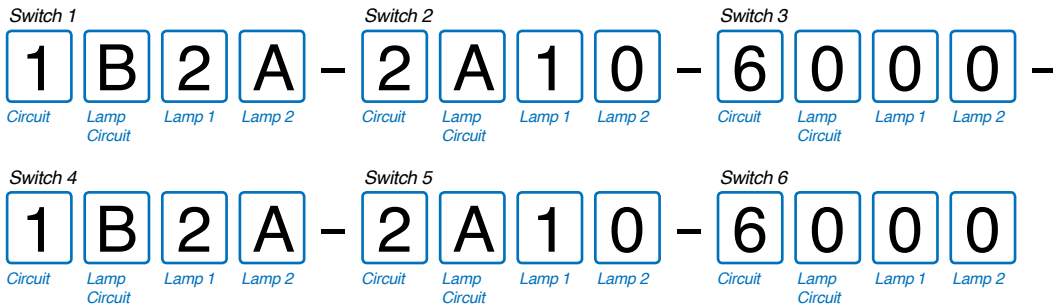

SWITCH CIRCUIT

1	2 Position Maintained
2	2 Position Momentary Top
3	2 Position Momentary Bottom
4	3 Position Momentary Bottom
5	3 Position Maintained
6	3 Position Momentary Top and Bottom
7	3 Position Momentary Top

LAMP 1

1	LED 1, Red
2	LED 1, Green
3	LED 1, Blue
4	LED 1, Amber
5	LED 1, White
0	No LED

LAMP CIRCUIT

A	L1 Backlight
B	L1, L2 Backlight
C	L2 Backlight
D	L1 Backlight, L2 Function Light
E	L1, L2 Function Light
F	L1 Function Light, L2 Backlight
G	L1 Function Light
H	L2 Function Light
0	No Lamp

LAMP 2

A	LED 2, Red
B	LED 2, Green
C	LED 2, Blue
D	LED 2, Amber
G	LED 2, White
0	No LED

Ordering Scheme: Part 3 (Rockers)

All Rocker options must match box 4 from part 1. For additional options, consult factory.

Contura II, III, IV, V, VII and XIV Rockers

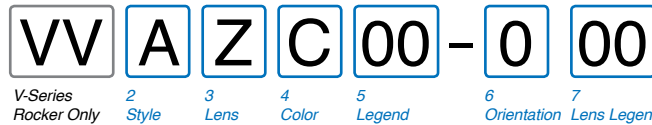

2 ACTUATOR STYLE

Contura II
A Thick over terminals 1-4
B Thick over terminals 3-6

Contura III
C Thick over terminals 1-4
D Thick over terminals 3-6

Contura IV
E Left brow, lens
T Left brow, laser-etched
F Right brow, lens
R Right brow, laser-etched

Contura V
G Contura V
P Laser-Etched

Contura VII
Z Contura VII

Contura XIV
FA Contura XIV
FB Laser-Etched

5 ACTUATOR LENS OR BODY LEGENDS

11 ON **12** OFF **13** I **14** O
 OFF ON O I

15 O O **16** O O **17** O I **18** I O
 F N N F F

See next page for standard icons. Consult factory for additional icons.

3 LENS

Z - No Lens		Contura Lens Style Location								
Clear	White	Amber	Green	Red	Blue	II	III	IV	V	XIV
1	6	8	G	M	T					
2	7	C	H	N	U					
3	8	D	J	P	V					
4	9	E	K	R	W		N/A			
5	A	F	L	S	Y		N/A			
5	A	N/A	N/A	N/A	N/A	Contura XIV laser-etched only				

Only **Contura VII**

Z - No Lens		Lens Style Location							
White	Amber	Green	Red	Blue	II	III	IV	V	XIV
6	B	G	M	T					
7	C	H	N	U					
8	D	J	P	V					
9	E	K	R	W					
A	F	L	S	Y					
1	2	3	4	5					

Lens color for LEDs must be clear, white, or match color of LED. Green or blue lenses are not recommended with Neon lamps.

6 LEGEND ORIENTATION

0 No legend (used with codes 11-18 in box 5)
1 Orientation 1
2 Orientation 2
3 Orientation 3
4 Orientation 4

Contura II

1 **2** **3** **4**

Contura III

1 **2** **3** **4**

Contura IV

1 **2** **3** **4**

Contura V

1 **2** **3** **4**

Contura VII

1 **2** **3** **4**

Contura XIV

1 **2** **3** **4**

7 ACTUATOR LENS LEGEND

00 No legend this location (used with codes 11-18 in box 5) Box 7 required when rocker requires two legends. If the two legends consist of one lens and one body legend, lens legend must be specified in box 5; body legend specified in box 7. See next page for standard icons. Consult factory for additional icons.

4 ACTUATOR COLOR AND TEXTURE

Contura II & Contura III
B black **G** gray **R** red **W** white (Soft Surface)
C black **H** gray **S** red **Y** white (Hard Surface)

Contura IV & Contura V
C black **H** gray **S** red **Y** white
 Laser-Etched only **D** nickel **E** pewter

Contura VII
C black **H** gray **S** red **Y** white

Contura XIV
C black **S** red **Y** white

Continue to next page for Contura VI (WAVE), Contura X, XI and XII rocker styles.

Ordering Scheme: Part 3 (Rockers): Continued

All Rocker options must match box 4 from part 1. For additional options, consult factory.

Contura VI (WAVE) Rocker Style

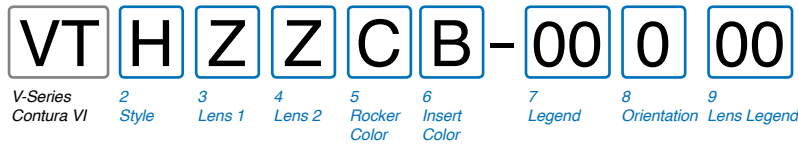

2 ACTUATOR STYLE
Contura VI
H High Insert **L** Low Insert

3, 4 LENS
Z - No Lens
 Clear White Amber Green Red Blue
 - 7 **C** **H** **N** **U** Bar Lens Translucent
3 - **D** **J** **P** **V** Bar Lens Transparent
4 - **E** **K** **R** **W** Oval Lens Transparent
 - **A** **F** **L** **S** **Y** Oval Lens Translucent
 Lens color for LEDs must be clear, white, or match color of LED. Green or blue lenses are not recommended with Neon lamps.

5 ACTUATOR COLOR
C Black **H** Gray **S** Red **Y** White

6 INSERT COLOR
B Black **N** Bright Nickel Plated
C Bright Chrome Plated **S** Satin Chrome Plated
D Satin Chrome Painted **T** Satin Nickel Plated
W White

7 ACTUATOR LENS OR BODY LEGENDS
00 - No Legend this location
11 ON **12** OFF **13** | **14** O
 OFF ON O I
15 O O **16** O O **17** O I **18** I O
 F N F N F F
 See next page for standard icons. Consult factory for additional icons.

8 LEGEND ORIENTATION
0 No legend (used with codes 11-18 in box 7)
1 Orientation 1
2 Orientation 2
3 Orientation 3
4 Orientation 4

9 ACTUATOR LENS LEGEND
00 No legend this location (used with codes 11-18 in box 7) Box 9 required when rocker requires two legends. If the two legends consist of one lens and one body legend, lens legend must be specified in box 7; body legend specified in box 9. See next page for standard icons. Consult factory for additional icons.

Contura X, XI and XII Rockers

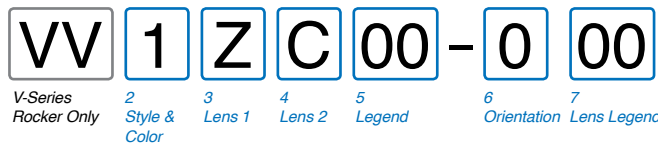

2 ACTUATOR STYLE
 Contura X Black 1 Gray 2 White 3 Red 4
 Contura XI 6 7 8 9
 Contura XII J K N M

4 LENS - ABOVE LAMP #1 TERMINALS
4 LENS - ABOVE LAMP #2 TERMINALS
Z - No Lens
 Clear White Amber Green Red Blue Lens Style
3 8 **D** **J** **P** **V** **Bar**
4 9 **E** **K** **R** **W** **One piece Square**
5 **A** **F** **L** **S** **Y** **Two piece Square***
2 7 **C** **H** **N** **U** **(With clear top protective lens)**
1 6 **B** **G** **M** **T** **Two piece Square***
(With smoke top protective lens)
(With white top protective lens)
 * All bottom lenses are molded of opaque material. Consult factory for other lens colors. Lens color for LEDs must be clear, white, or match color of LED. Green or blue lenses are not recommended with Neon lamps.

5 ACTUATOR LENS OR BODY LEGEND
00 - No Legend this location
11 ON **12** OFF **13** | **14** O
 OFF ON O I
15 O O **16** O O **17** O I **18** I O
 F N F N F F
21 OFF **22** ON **23** O **24** I
25 O **26** O **27** O **28** I
 F N F
 For additional legend options & codes, visit us at www.carlingtech.com.

6 LEGEND ORIENTATION
0 No legend (used with codes 11-18 in selection 12)
1 Orientation 1
2 Orientation 2
3 Orientation 3
4 Orientation 4

7 ACTUATOR LENS LEGEND
00 No legend this location (used with codes 11-18 in box 5) Box 7 required when rocker requires two legends. If the two legends consist of one lens and one body legend, lens legend must be specified in box 5; body legend specified in box 7. See next page for standard icons. Consult factory for additional icons.

Standard Legend Imprinting Codes:

YK	UA	UB	US	UV	UW	UX	UY	MP	MR	MT	VU	PS
			NAV LIGHTS	COURT LIGHTS	PANEL LIGHTS	ANCH LIGHTS	HEAD LIGHTS	FOG LIGHTS	DASH LIGHTS	DOCK LIGHTS	BEACON	LIGHT
WM	RN	RP	VD	VE	VF	VG	SH	SM	SN	SP	SR	SY
DIM	BRIGHT						BILGE PUMP	BILGE				
WY	WZ	UH	UJ	PD	PE	PF	VC	VJ	UF	UG	MU	TN
		WIPER							BLWR			
NS	PB	SE	VZ	YE	UE	NM	RJ	NR	VA	UC	VN	PK
	HORN							UP	DOWN			
VY	UZ	RB	RC	RK	RL	MZ	RG	WS	WT	UD	UR	WD
			WATER PUMP			ANCHOR						
TY	PA	UK	WR	UU	UT	YR	VS	UL	UM	VP	YJ	UN
								AUX	ON OFF	OFF ON	I O	O I
YF	TH	TF	TH	TF	TG	YS	YH	SX	RZ	YP	WN	WP
OFF ON	ON	OFF	I	O	II	RAISE	LOWER	HIGH	LOW	FWD	REV	DEPTH
WW	WX	SA	SB	SC	SD	ST	SU	WU	WV	SV	SW	VB
TRIM TAB	ACC	NAV ANCH	WIND LASS UP/DN	LIVE WELL	REAR	PARK	AUTO					
VH	VK	VL	VM	WE	SF	SG	SS	RU	RV	RX		

Notes:

- 1 ISO compliant symbols. Consult factory for custom legends.
- 2 New legend codes recommended for new part set ups. Previous codes still valid for existing customers.

Dimensional Specifications: in. [mm]

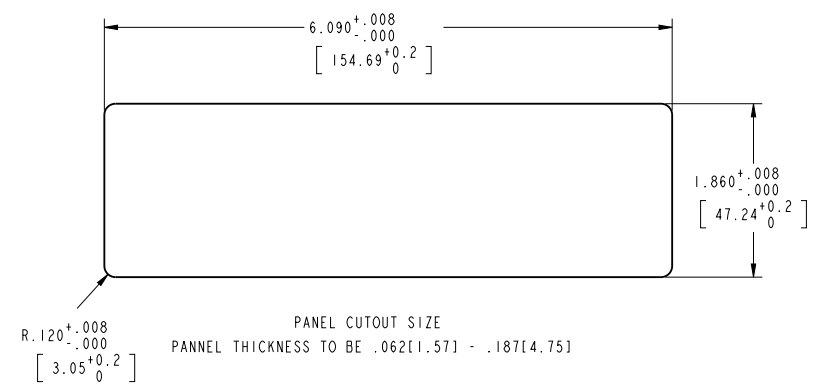
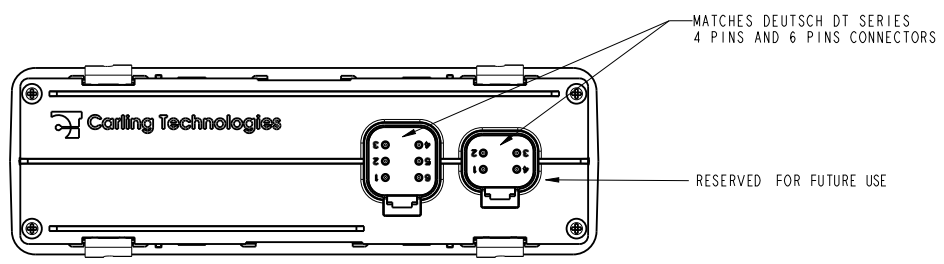
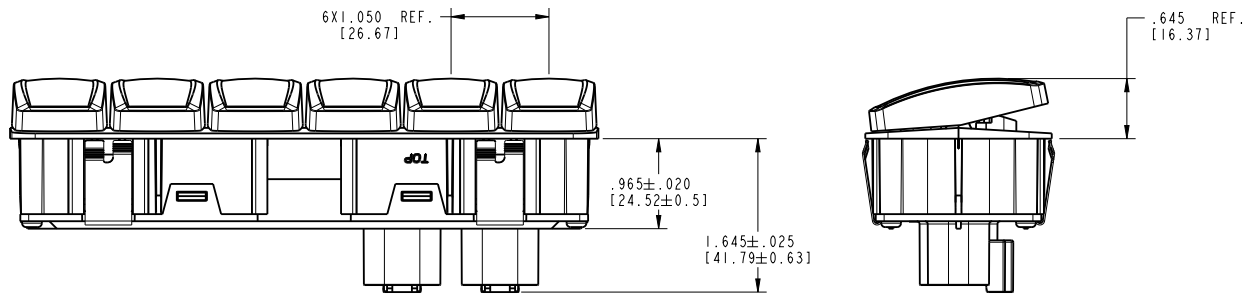
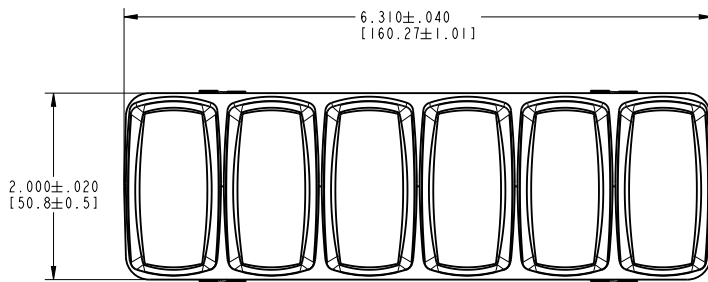

CLA-0147 Rev: A

Dimensional Specifications: in. [mm]

ORIENTATION

LANDSCAPE

TOP

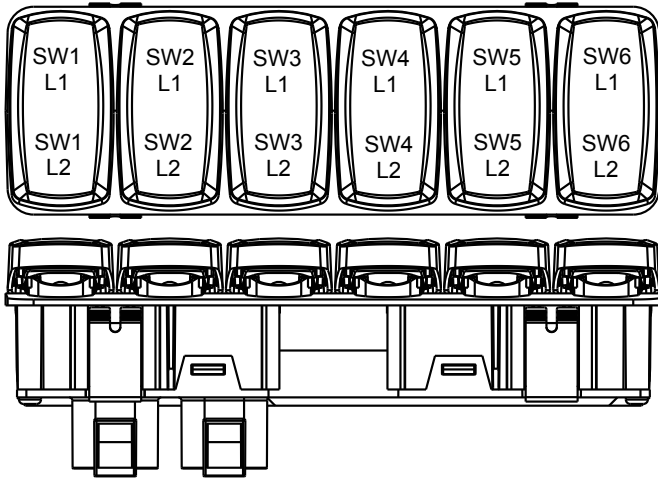

PORTRAIT

TOP

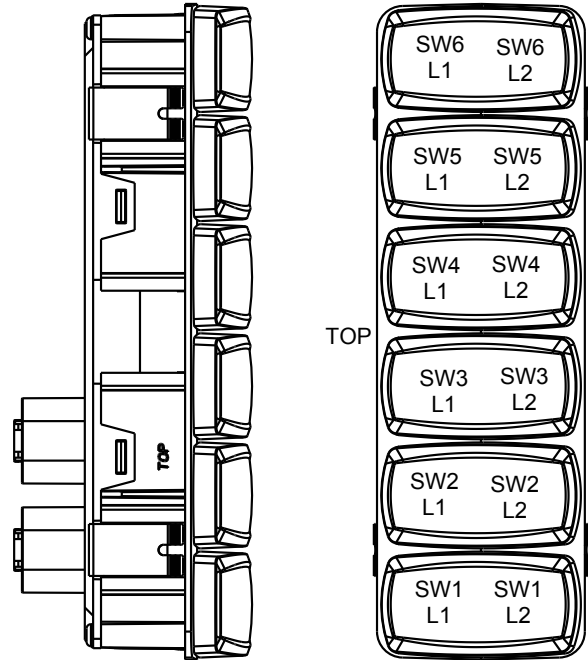

REVERSE LANDSCAPE

TOP

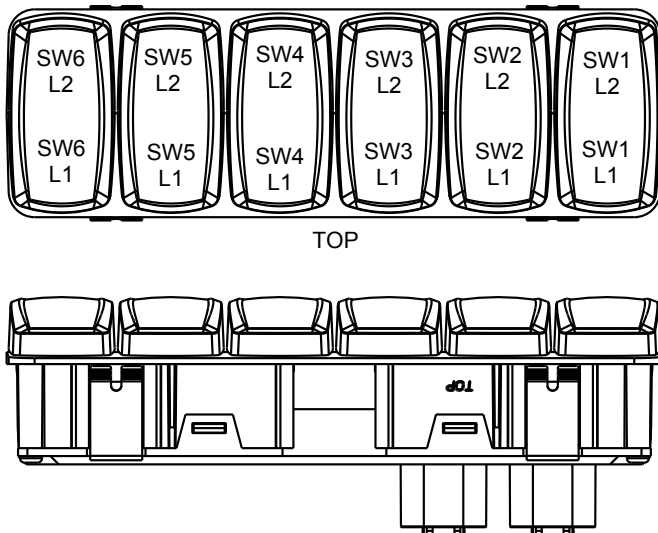

REVERSE PORTRAIT

TOP

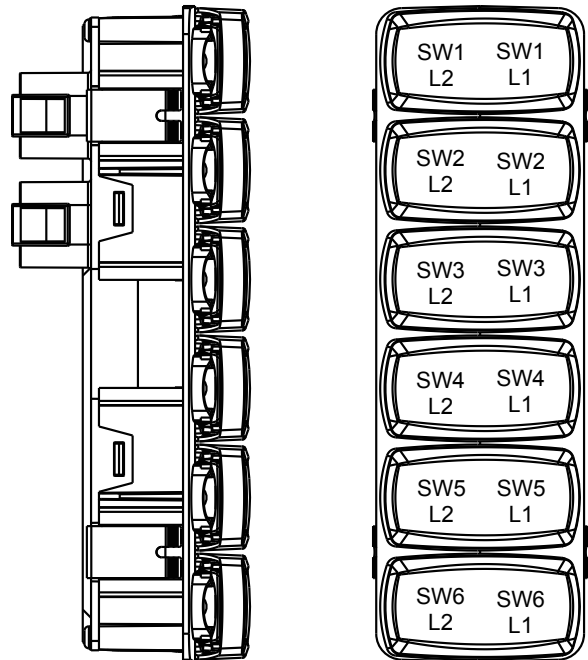

Interface Adapter Cable: Deutsch to CAN (A3702)

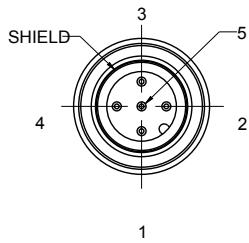
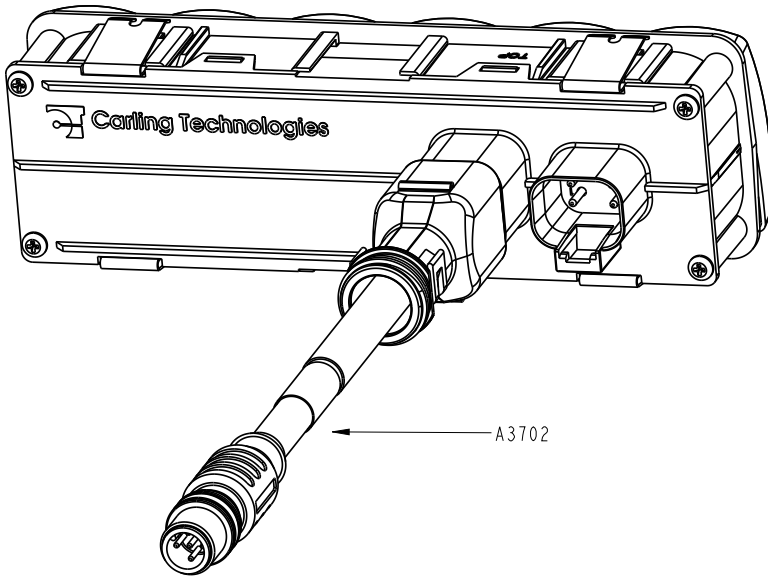
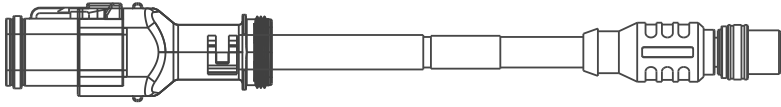

DETAIL A

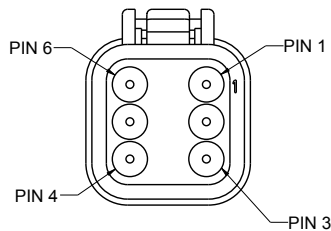

DETAIL B

Worldwide Headquarters

Carling Technologies, Inc.
60 Johnson Avenue, Plainville, CT 06062
Phone: 860.793.9281 **Fax:** 860.793.9231
Email: sales@carlingtech.com

Northern Region Sales Office: nrsm@carlingtech.com
Southeast Region Sales Office: sersm@carlingtech.com
Midwest Region Sales Office: mrrsm@carlingtech.com
West Region Sales Office: wrsm@carlingtech.com
Latin America Sales Office: larsm@carlingtech.com

Asia-Pacific Headquarters

Carling Technologies, Asia-Pacific Ltd.,
Kowloon, Hong Kong
Phone: Int + 852-2737-2277 **Fax:** Int + 852-2736-9332
Email: sales@carlingtech.com.hk

Shenzhen, China: shenzhen@carlingtech.com
Shanghai, China: shanghai@carlingtech.com
Pune, India: india@carlingtech.com
Kaohsiung, Taiwan: taiwan@carlingtech.com
Yokohama, Japan: japan@carlingtech.com

Europe | Middle East | Africa Headquarters

Carling Technologies LTD
4 Airport Business Park, Exeter Airport,
Clyst Honiton, Exeter, Devon, EX5 2UL, UK
Phone: Int + 44 1392.364422 **Fax:** Int + 44 1392.364477
Email: ltd.sales@carlingtech.com

Germany: gmbh@carlingtech.com
France: sas@carlingtech.com



Carling Technologies®

Innovative Designs. Powerful Solutions.