

Relay interface modules 6 - 7 - 10 A



Control panels



Packaging machines



Shipyards



Textile machines



Carousel warehouses



Panels for electrical distribution



Hoists and cranes



Wood-processing machines

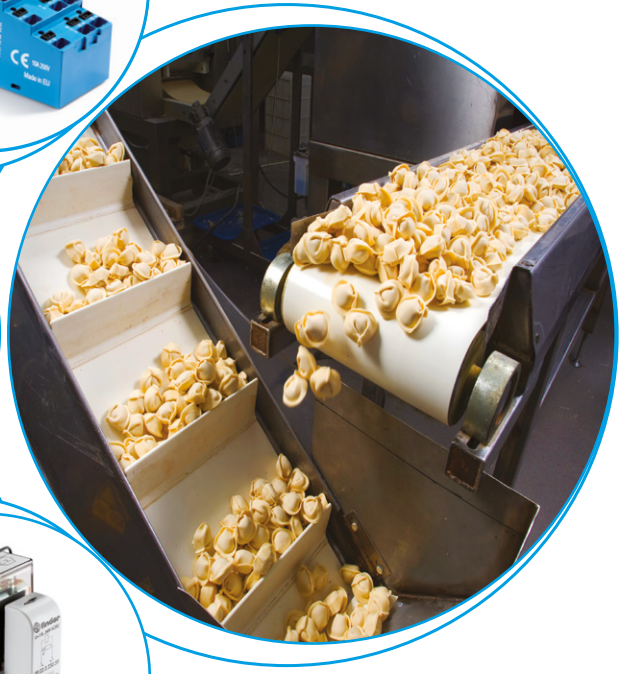
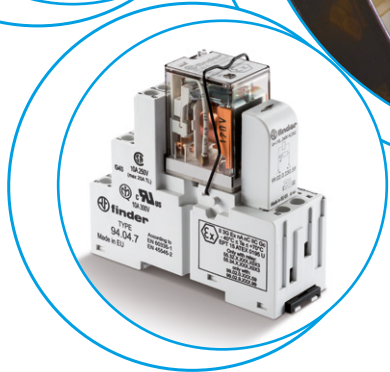
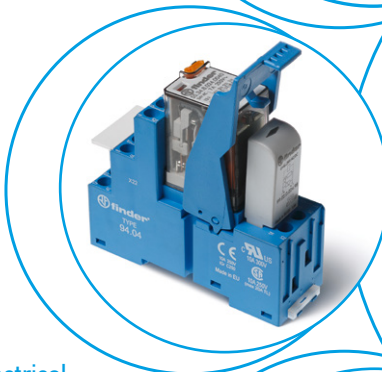
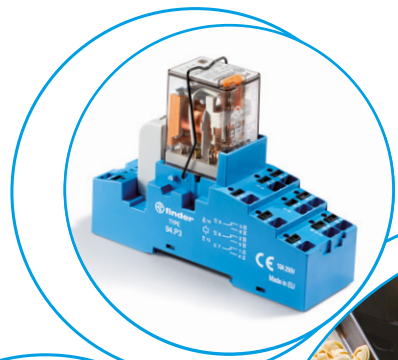

**3 & 4 CO relay interface modules,
31 mm wide with Push-in terminals**
Ideal interface for PLC and electronic systems

Type 58.P3

- 3 CO 10 A
- Push-in terminals

Type 58.P4

- 4 CO 7 A
- Push-in terminals

- AC coils or DC coils
- Supply status indication and EMC coil suppression module as standard
- Identification label
- Cadmium Free contacts
- UL Listing (certain relay/socket combinations)
- **Atex** compliant (Ex ec nC) option available
- **HazLoc** Class I Div. 2 Groups A, B, C, D - T5 option available
- 35 mm rail (EN 60715) mounting

58.P3 / 58.P4
Push-in terminals



For outline drawing see page 10

Contact specification

Contact configuration		3 CO (3PDT)	4 CO (4PDT)
Rated current/Maximum peak current	A	10/20	7/15
Rated voltage/ Maximum switching voltage	V AC	250/400	250/250
Rated load AC1	VA	2500	1750
Rated load AC15 (230 V AC)	VA	500	350
Single phase motor rating (230 V AC)	kW	0.37	0.125
Breaking capacity DC1: 30/110/220 V	A	10/0.5/0.25	7/0.5/0.25
Minimum switching load	mW (V/mA)	300 (5/5)	300 (5/5)
Standard contact material		AgNi	AgNi

Coil specification

Nominal voltage (U _N)	V AC (50/60 Hz)	12 - 24 - 48 - 110 - 120 - 230	12 - 24 - 48 - 110 - 120 - 230
	V DC	12 - 24 - 48 - 125	12 - 24 - 48 - 125
Rated power AC/DC	VA (50 Hz)/W	1.5/1	1.5/1
Operating range	AC	(0.8...1.1)U _N	(0.8...1.1)U _N
	DC	(0.8...1.1)U _N	(0.8...1.1)U _N
Holding voltage	AC/DC	0.8 U _N / 0.5 U _N	0.8 U _N / 0.5 U _N
Must drop-out voltage	AC/DC	0.2 U _N / 0.1 U _N	0.2 U _N / 0.1 U _N

Technical data

Mechanical life AC/DC	cycles	20 · 10 ⁶ / 50 · 10 ⁶	20 · 10 ⁶ / 50 · 10 ⁶
Electrical life at rated load AC1	cycles	200 · 10 ³	150 · 10 ³
Operate/release time	ms	10/5 (AC) - 10/15 (DC)	11/3 (AC) - 11/15 (DC)
Insulation between coil and contacts (1.2/50 μs)	kV	3.6	3.6
Dielectric strength between open contacts	V AC	1000	1000
Ambient temperature range	°C	-40...+70	-40...+70
Protection category		IP 20	IP 20

Approvals relay (according to type)



- 3 CO 10 A
- Push-in terminals

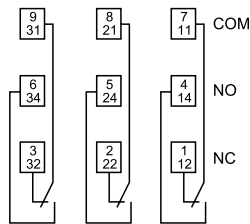

Example: AC

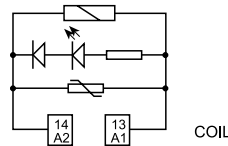

- 4 CO 7 A
- Push-in terminals

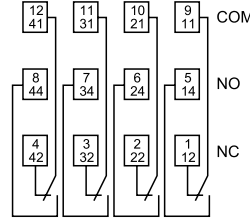

Example: DC

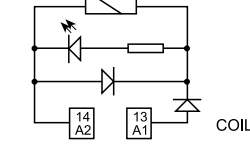

**2, 3 & 4 CO relay interface modules,
27 mm wide with Screw terminals**
Ideal interface for PLC and electronic systems

Type 58.32

- 2 CO 10 A
- Screw terminals

Type 58.33

- 3 CO 10 A
- Screw terminals

Type 58.34

- 4 CO 7 A
- Screw terminals

- AC coils or DC coils
- Supply status indication and EMC coil suppression module as standard
- Identification label
- Cadmium Free contacts
- UL Listing (certain relay/socket combinations)
- 35 mm rail (EN 60715) mounting

58.32 / 58.33 / 58.34
Screw terminals



For outline drawing see page 10

Contact specification

Contact configuration		2 CO (DPDT)	3 CO (3PDT)	4 CO (4PDT)
Rated current/Maximum peak current	A	10/20	10/20	7/15
Rated voltage/ Maximum switching voltage	V AC	250/400	250/400	250/250
Rated load AC1	VA	2500	2500	1750
Rated load AC15 (230 V AC)	VA	500	500	350
Single phase motor rating (230 V AC)	kW	0.37	0.37	0.125
Breaking capacity DC1: 30/110/220 V	A	10/0.5/0.25	10/0.5/0.25	7/0.5/0.25
Minimum switching load	mW (V/mA)	300 (5/5)	300 (5/5)	300 (5/5)
Standard contact material		AgNi	AgNi	AgNi

Coil specification

Nominal voltage (U _N)	V AC (50/60 Hz)	12 - 24 - 48 - 110 - 120 - 230	12 - 24 - 48 - 110 - 120 - 230	12 - 24 - 48 - 110 - 120 - 230
	V DC	12 - 24 - 48 - 125	12 - 24 - 48 - 125	12 - 24 - 48 - 125
Rated power AC/DC	VA (50 Hz)/W	1.5/1	1.5/1	1.5/1
Operating range	AC	(0.8...1.1)U _N	(0.8...1.1)U _N	(0.8...1.1)U _N
	DC	(0.8...1.1)U _N	(0.8...1.1)U _N	(0.8...1.1)U _N
Holding voltage	AC/DC	0.8 U _N / 0.5 U _N	0.8 U _N / 0.5 U _N	0.8 U _N / 0.5 U _N
Must drop-out voltage	AC/DC	0.2 U _N / 0.1 U _N	0.2 U _N / 0.1 U _N	0.2 U _N / 0.1 U _N

Technical data

Mechanical life AC/DC	cycles	20 · 10 ⁶ / 50 · 10 ⁶	20 · 10 ⁶ / 50 · 10 ⁶	20 · 10 ⁶ / 50 · 10 ⁶
Electrical life at rated load AC1	cycles	200 · 10 ³	200 · 10 ³	150 · 10 ³
Operate/release time	ms	10/5 (AC) - 10/15 (DC)	10/5 (AC) - 10/15 (DC)	11/3 (AC) - 11/15 (DC)
Insulation between coil and contacts (1.2/50 μs)	kV	3.6	3.6	3.6
Dielectric strength between open contacts	V AC	1000	1000	1000
Ambient temperature range	°C	-40...+70	-40...+70	-40...+70
Protection category		IP 20	IP 20	IP 20

Approvals relay (according to type)



58.32



- 2 CO 10 A
- Screw terminals

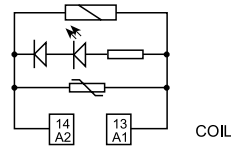
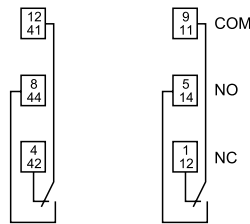

Example: AC

58.33



- 3 CO 10 A
- Screw terminals

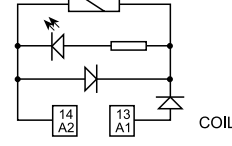
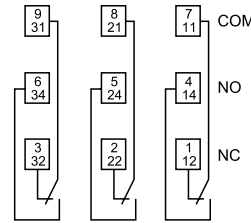

Example: DC

58.34



- 4 CO 7 A
- Screw terminals

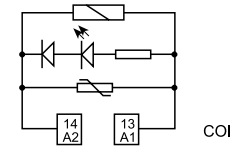
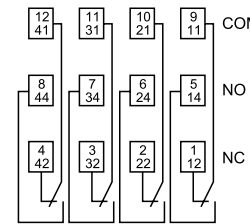

Example: AC

**2 & 4 CO relay interface modules,
27 mm wide with Screw or sockets version
with Push-in terminals**

**ATEX compliant (EX ec nC)
HazLoc Class I Div. 2 Groups A, B, C, D - T5
compliant**

Type 58.32 - x0xx

- 2 CO 10 A
- Screw terminals
- Push-in terminals sockets version (94.Px) available

Type 58.34 - x0xx

- 4 CO 6 A
- Screw terminals
- Push-in terminals sockets version (94.Px) available
- AC coils or DC coils
- Supply status indication and EMC coil suppression module as standard
- Mechanical indicator - optional on 2 & 4 CO types
- Identification label
- Cadmium Free contacts
- UL Listed
- Complies with:
 - EN 60079-0:2012+A11:2013;
 - EN 60079-15:2010; EN 60079-7:2015 and 2014/34/UE
- 35 mm rail (EN 60715) mounting

58.32 / 58.34 - x0xx
Screw terminals



For outline drawing see page 10

Contact specification

Contact configuration		2 CO (DPDT)	4 CO (4PDT)
Rated current/Maximum peak current*	A	10/20	6/15
Rated voltage/ Maximum switching voltage	V AC	250/400	250/250
Rated load AC1	VA	2500	1500
Rated load AC15 (230 V AC)	VA	500	350
Single phase motor rating (230 V AC)	kW	0.37	0.125
Breaking capacity DC1: 30/110/220 V	A	10/0.25/0.12	6/0.25/0.12
Minimum switching load	mW (V/mA)	300 (5/5)	300 (5/5)
Standard contact material		AgNi	AgNi

Coil specification

Nominal voltage (U _N)	V AC (50/60 Hz)	12 - 24 - 48 - 110 - 120 - 230	12 - 24 - 48 - 110 - 120 - 230
	V DC	12 - 24 - 48 - 125	12 - 24 - 48 - 125
Rated power AC/DC	VA (50 Hz)/W	1.5/1	1.5/1
Operating range	AC	(0.8...1.1)U _N	(0.8...1.1)U _N
	DC	(0.8...1.1)U _N	(0.8...1.1)U _N
Holding voltage	AC/DC	0.8 U _N / 0.5 U _N	0.8 U _N / 0.5 U _N
Must drop-out voltage	AC/DC	0.2 U _N / 0.1 U _N	0.2 U _N / 0.1 U _N

Technical data

Mechanical life AC/DC	cycles	20 · 10 ⁶ / 50 · 10 ⁶	20 · 10 ⁶ / 50 · 10 ⁶
Electrical life at rated load AC1	cycles	150 · 10 ³	150 · 10 ³
Operate/release time	ms	11/3 (AC) - 11/15 (DC)	11/3 (AC) - 11/15 (DC)
Insulation between coil and contacts (1.2/50 µs)	kV	3.6	3.6
Dielectric strength between open contacts	V AC	1000	1000
Ambient temperature range*	°C	-40...+70*	-40...+70*
Protection category		IP 20	IP 20

Approvals relay (according to type)

58.32 - x0xx

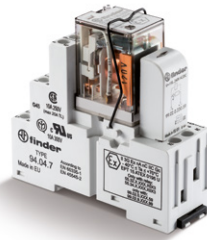

- 2 CO 10 A
- Screw terminals or Push-in terminals sockets version (94.Px) available
- ATEX, Hazardous Location compliant

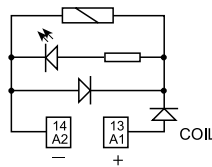
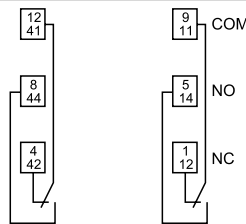

Example: DC

58.34 - x0xx

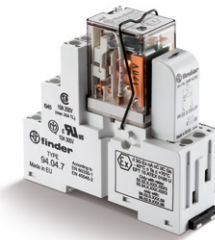

- 4 CO 6 A
- Screw terminals or Push-in terminals sockets version (94.Px) available
- ATEX, Hazardous Location compliant

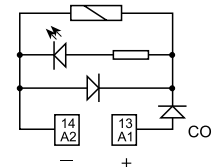
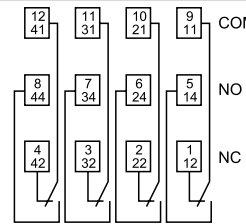

Example: DC

* See page 7 for details of rated current and ambient temperature approval characteristic



Ordering information

Example: 58 series, 35 mm rail (EN 60715) mounting, Push-in terminals interface module, 4 CO, 24 V DC coil, green LED + diode.

B

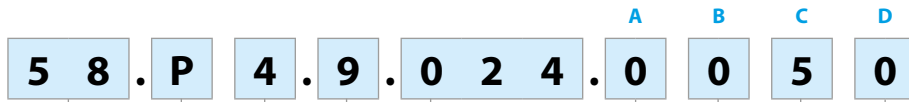

Series ————
Type ————
3 = Screw terminals
35 mm rail (EN 60715) mount
P = Push-in terminals
35 mm rail (EN 60715) mount

No. of poles ————
2 = 2 pole, 10 A
3 = 3 pole, 10 A
4 = 4 pole, 7 A

Coil version ————
8 = AC (50/60 Hz)
9 = DC

Coil voltage ————
See coil specifications

A: Contact material
0 = AgNi Standard
5 = AgNi + Au

B: Contact circuit
0 = CO (nPDT)

D: Special versions
0 = Standard

C: Options
5 = Standard DC: green LED + diode
(polarity +A1)
6 = Standard AC: green LED + Varistor

Selecting features and options: only combinations in the same row are possible.
Preferred selections for best availability are shown in **bold**.

Type	Coil version	A	B	C	D
58.P3/P4/32/33/34	AC	0 - 5	0	6	0
58.P3/P4/32/33/34	DC	0 - 5	0	5	0

Ordering information ATEX and Hazardous Location versions

Example: 58 series, 35 mm rail (EN 60715), screw terminal interface module, 4 CO, 120 V AC, green LED, mechanical indicator, ATEX and HazLoc Version.



Series ————
Type ————
3 = Screw terminals
35 mm rail (EN 60715) mount
P = Push-in terminals
35 mm rail (EN 60715) mount

No. of poles ————
2 = 2 pole, 10 A
4 = 4 pole, 6 A

Coil version ————
8 = AC (50/60 Hz)
9 = DC

Coil voltage ————
See coil specifications

A: Contact material
0 = AgNi Standard
2 = AgCdO
5 = AgNi + Au

B: Contact circuit
0 = CO (nPDT)

D: Special versions
8 = Atex (Ex ec nC) and HazLoc Class I
Div. 2 compliant without mechanical
indicator
9 = Atex (Ex ec nC) and HazLoc Class I
Div. 2 compliant with mechanical
indicator

C: Options (Not for 58.Px version)
4 = Module 99 LED (AC/DC)
5 = Module 99
LED + Diode (DC)
6 = Module 99 LED + Varistor (AC/DC)
7 = Timer 86.30 (12-24 V AC/DC)

Selecting features and options: only combinations in the same row are possible.

Type	Coil version	A	B	C	D
58.3x	AC/DC	0 - 2 - 5	0	4 - 5 - 6 - 7	8 - 9
58.Px	AC/DC	0 - 2 - 5	0	0	8 - 9

Technical data

Insulation				
Insulation according to EN 61810-1	insulation rated voltage	V	400 (2-3 pole)	250 (4 pole)
	rated impulse withstand voltage	kV	3.6 (2-3 pole)	2.5 (4 pole)
	pollution degree		2	2
	overvoltage category		III	II
Insulation between coil and contacts (1.2/50 µs)		kV	3.6	
Dielectric strength between open contacts		V AC	1000	
Dielectric strength between adjacent contacts		V AC	2000 (58.32,58.33, 58.P3)	1550 (58.34, 58.P4)
Insulation between coil terminals				
Rated impulse voltage (surge) differential mode (according to EN 61000-4-5)		kV (1.2/50 µs)	4	
Other data				
Bounce time: NO/NC		ms	1/3	
Vibration resistance (10...55)Hz: NO/NC		g	6/6	
Power lost to the environment	without contact current	W	1	
	with rated current	W	3 (58.32, 58.34, 58.P4)	4 (58.P3, 58.33)
			58.32/33/34 (screw terminals)	58.P3/P4 (Push-in terminals)
Wire strip length		mm	8	
Screw torque		Nm	0.5	
Min. wire size		mm ²	solid cable	stranded cable
			0.5	0.5
			AWG 21	21
Max. wire size		mm ²	solid cable	stranded cable
			1 x 6 / 2 x 2.5	1 x 4 / 2 x 2.5
			AWG 1 x 10 / 2 x 14	1 x 12 / 2 x 14
			solid cable	stranded cable
			0.5	0.5
			21	21
			1 x 1.5 / 1 x 2.5	2 x 1.5 / 1 x 2.5
			2 x 16 / 1 x 14	2 x 16 / 1 x 14

ATEX - HazLoc - Electrical characteristics

Max current @ 70 °C (max temperature ATEX applications)		Single piece mount	> 1 piece mount
Type 58.x2	A	10	7
Type 58.x4	A	6	5
Max current @ 40 °C (max temperature Hazloc applications)		Single piece mount	> 1 piece mount
Type 58.x2	A	9	9
Type 58.x4	A	5	5
Terminal			
Wire strip length		mm	8
Screw torque		Nm	0.5
Wire size		solid cable	stranded cable
		mm ²	1 x 2.5
		AWG	1 x 12

Markings - ATEX versions - ATEX, II 3G Ex ec nC IIC Gc

MARKING	
	Specific marking of explosion protection
II	Component for surface plant (different from mines)
3	Category 3: normal level of protection
GAS	G Explosive atmosphere due to presence of combustible gas vapour or mist
	Ex ec Increased Safety
	Ex nC Sealed device (type of protection for category 3G)
	IIC Gas group
	Gc Equipment Protection Level
-40 °C ≤ Ta ≤ +70 °C Ambient temperature	
EPTI 15 ATEX 0195 U EPTI: laboratory which issues the CE type certificate 15: year of issue of certificate 0195: number of CE type certificate U: ATEX component	

Markings - Hazardous Location Class I Div. 2 Groups A, B, C, D - T5 and other data

HazLoc Class I Div. 2 Group A, B, C, D - T5		Meaning
Class I		Areas in which flammable gases and vapours may be present
Div. 2		Low probability to find ignitable hazardous concentration because it is typically present in closed system from which can escape through breakdown or accidental rupture
Group A, B, C, D		Kind of combustible, flammable gases and vapours can be in the atmosphere
Permissible Surface temperature		
T5	100 °C	212 °F

ATEX and HazLoc - Electrical characteristics

Interface Code	Atex current [A] rating -40...+70°C		HazLoc current [A] rating -25...40°C group mounting	
	Single mounting	Group mounting	24 V DC	230 V AC
58.32.x.xxx	10	7	9	9
58.34.x.xxx	6	5	5	5
58.P2.x.xxx	10	7	9	9
58.P4.x.xxx	6	5	5	5

Contact specification

F 58 - Electrical life (AC) v contact current
2 & 3 pole relays

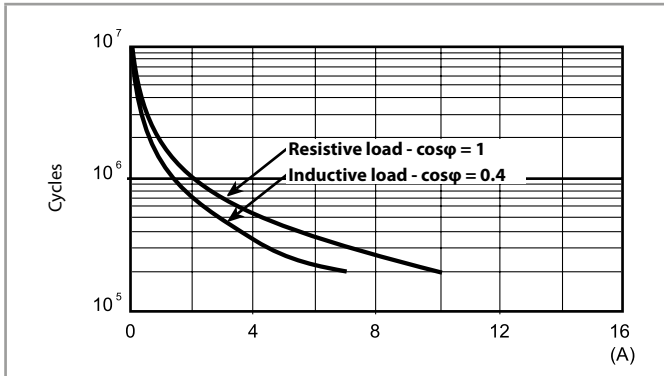

F 58 - Electrical life (AC) v contact current
4 pole relay

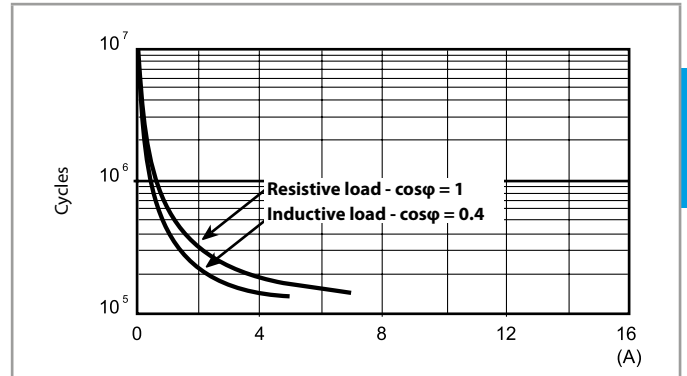

H 58 - Maximum DC1 breaking capacity

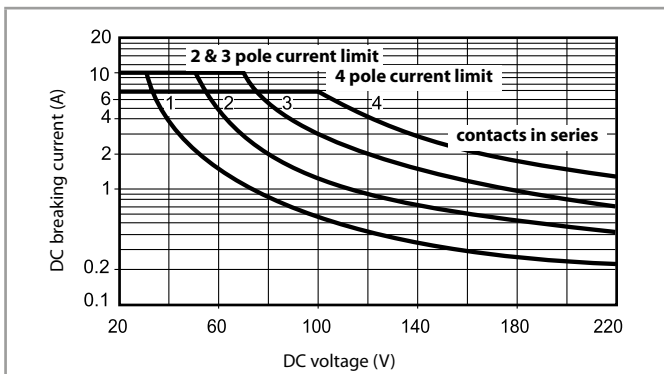

- When switching a resistive load (DC1) having voltage and current values under the curve, an electrical life of $\geq 100 \cdot 10^3$ can be expected.
- In the case of DC13 loads, the connection of a diode in parallel with the load will permit a similar electrical life as for a DC1 load.
Note: the release time for the load will be increased.

Coil specifications

DC coil data

Nominal voltage	Coil code	Operating range		Resistance	Rated coil absorption
		U_{min}	U_{max}		
U_N		V	V	R	I at U_N
V		V	V	Ω	mA
12	9.012	9.6	13.2	140	86
24	9.024	19.2	26.4	600	40
48	9.048	38.4	52.8	2400	20
125	9.125	100	138	17300	7.2

AC coil data

Nominal voltage	Coil code	Operating range		Resistance	Rated coil absorption
		U_{min}	U_{max}		
U_N		V	V	R	I at U_N (50 Hz)
V		V	V	Ω	mA
12	8.012	9.6	13.2	50	97
24	8.024	19.2	26.4	190	53
48	8.048	38.4	52.8	770	25
110	8.110	88	121	4000	12.5
120	8.120	96	132	4700	12
230	8.230	184	253	17000	6

R 58 - DC coil operating range v ambient temperature

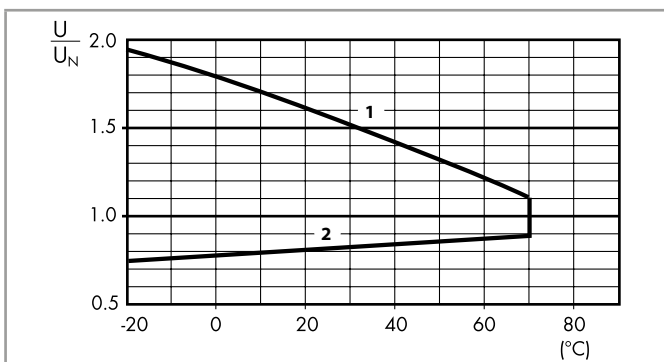

R 58 - AC coil operating range v ambient temperature

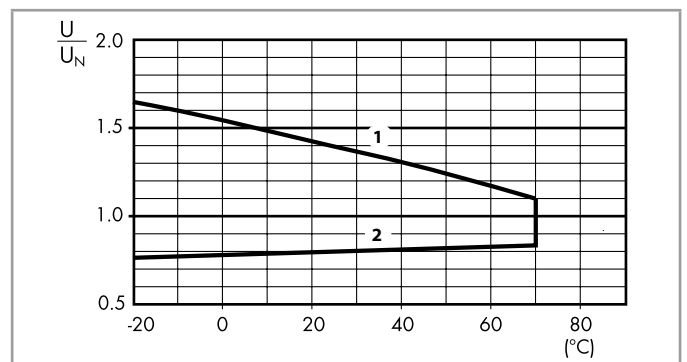

- 1 - Max. permitted coil voltage.
2 - Min. pick-up voltage with coil at ambient temperature.

- 1 - Max. permitted coil voltage.
2 - Min. pick-up voltage with coil at ambient temperature.

Combinations

Code	Type of socket	Type of relay	Module	Retaining clip
58.P3	94.P3	55.33	99.02	094.91.3
58.P4	94.P4	55.34	99.02	094.91.3
58.32	94.02	55.32	99.02	094.91.3
58.33	94.03	55.33	99.02	094.91.3
58.34	94.04	55.34	99.02	094.91.3

Certain relay/socket combinations

B Outline drawings

Type 58.32
Screw terminals

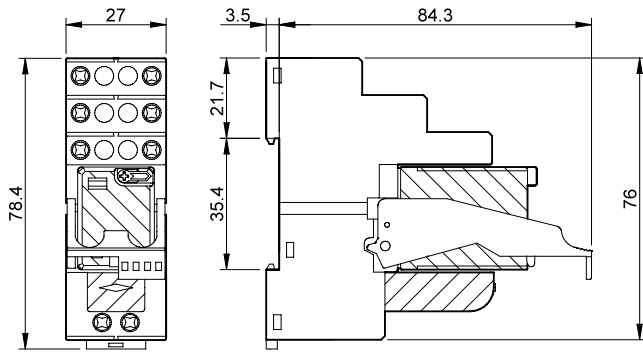

Type 58.33
Screw terminals

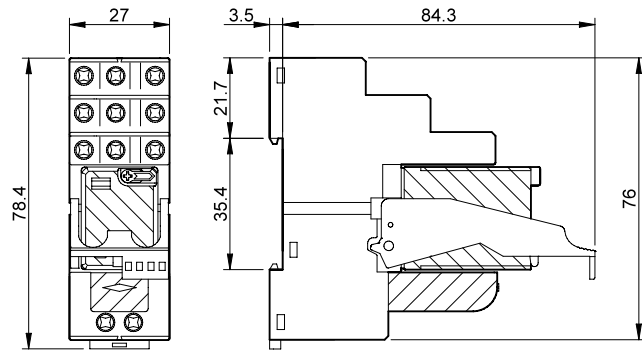

Type 58.34
Screw terminals

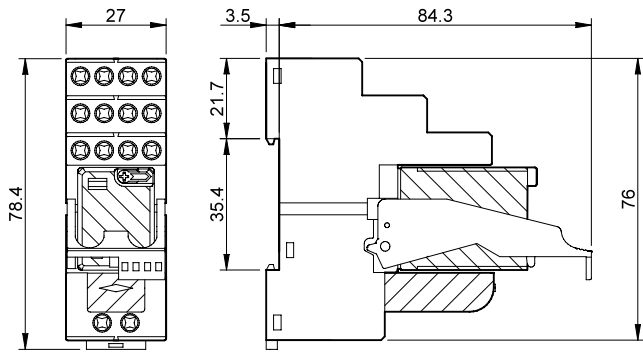

Type 58.P3
Push-in terminals

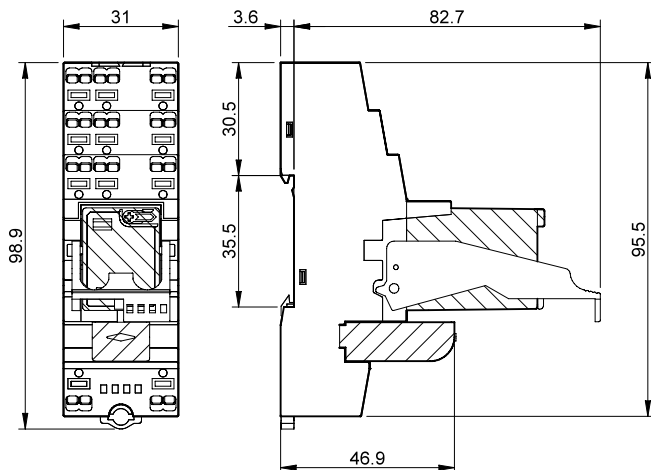

Type 58.P4
Push-in terminals

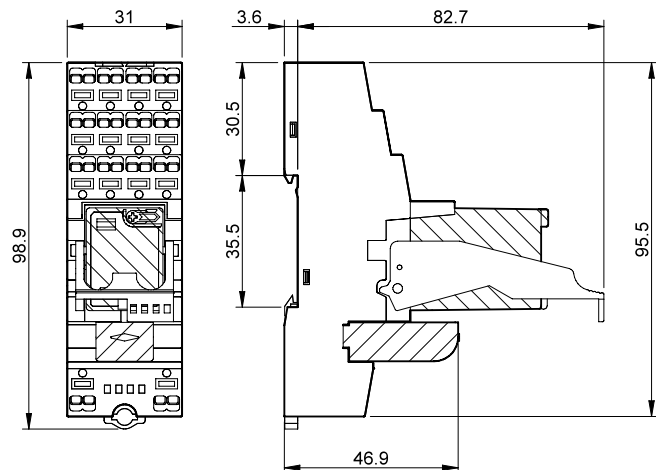

Accessories



094.52.1

2-way jumper link for type 58.P3 and 58.P4	094.52.1
Rated values	10 A - 250 V

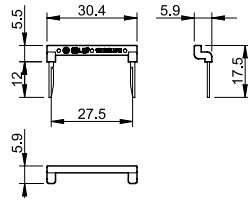

097.52

2-way jumper link for type 58.P3 and 58.P4	097.52
Rated values	10 A - 250 V

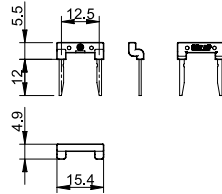

097.00

Marker tag holder for type 58.P3, 58.P4, 58.32, 58.33 and 58.34	097.00
--	--------

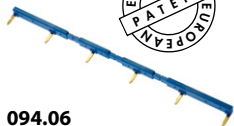
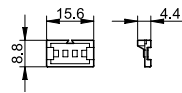

094.06



6-way jumper link for type 58.32, 58.33, 58.34	094.06 (blue)	094.06.0 (black)
Rated values	10 A - 250 V	

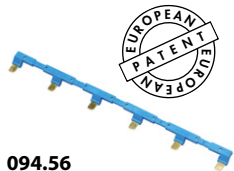
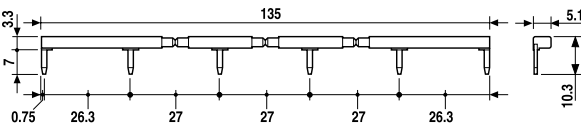

094.56



6-way jumper link for type 58.P3 and 58.P4	094.56 (blue)
Rated values	10 A - 250 V

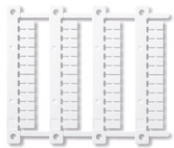
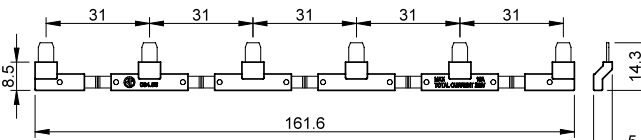

060.48

Sheet of marker tags , plastic, 48 tags, 6 x 12 mm	060.48
---	--------

Packaging codes

How to code and identify retaining clip and packaging options for sockets.

Example:

5 8 . P 4 . 9 . 0 2 4 . 0 0 5 0 S P A

A Standard packaging
B Blister packaging

SP Plastic retaining clip
SM Metallic retaining clip (58.P2/P4/32/34) Atex and HazLoc Versions only

